

# March 2015 Council Purple Draft



## Bikeways & Trails Facilities Plan

Albuquerque, NM

2014

Draft Plan  
Prepared for City Council  
March 13, 2015

**Blue Text** = Changes during the EPC Stage

**Red Text** = Changes made during the LUPZ Subcommittee Stage

**Purple Text** = Changes made prior to the first full City Council Hearing

**DRAFT**  
**Bikeways & Trails Facility Plan**

**March 2015 – City Council Purple-Line**



**Published by: City of Albuquerque Planning Department**  
**600 2<sup>nd</sup> Street NW**  
**Albuquerque, NM 87102**

## Acknowledgements:

### **City of Albuquerque**

Richard J. Berry, Mayor  
Robert J. Perry, Chief Administrative  
Officer

### **City Council**

Ken Sanchez, District 1, President  
Isaac Benton, District 2  
Klarissa Peña, District 3  
Brad Winter, District 4  
Dan Lewis, District 5  
Rey Garduño, District 6  
Diane G. Gibson, District 7  
Trudy E. Jones, District 8, Vice-President  
Don Harris, District 9

### **Environmental Planning Commission**

Patrick J. Griebel, Esq., District 1  
Moises A. Gonzalez, District 2  
Victor Beserra, District 3  
Peter D. Nicholls, District 4, Chair  
Derek Bohannon, District 5  
Maia J. Mullen, District 6  
James A. Peck, District 7, Vice-Chair  
Karen L. Hudson, District 8  
Bill W. McCoy III, District 9

### **GABAC**

Scott Hale, Chair  
Diane Albert  
Larry Gilbert  
Ronald Nelson  
Douglas Stiebler  
Ed Hillsman  
Bruce Farmer  
Moises Gonzalez, EPC Representative  
[Dan Majewski](#)  
[Mark Aasmundstad](#)  
[Scott Key](#)

### **GARTC**

Ian Maddieson, Chair  
Gary Kelly, Vice Chair  
Warren Wild  
William Schimberg  
John Thomas  
Guy Miller  
Valerie Cole

### **City and Technical Staff**

Suzanne Lubar, Director, Planning Department  
Russell Brito, Planning Department  
Carrie Barkhurst, Planning Department  
Jessica Johnson, Planning Department  
Petra Morris, Planning Department

Michael Riordan, Director, Department of  
Municipal Development  
Debbie Bauman, DMD  
John MacKenzie, DMD

Barbara Baca, Director, Parks & Recreation  
Christina Sandoval, Parks & Recreation  
James Lewis, Parks & Recreation  
Carol Dumont, Parks & Recreation

### **Consultants**

Gannett Fleming West  
Alta Planning  
[Consensus Builder](#)  
[Harwick Transportation Group](#)  
Susan Kelly  
Diane Scena



---

# PART I: BACKGROUND & POLICIES

---

<i>Executive Summary</i> .....	<i>i</i>
<b>CHAPTER 1: INTRODUCTION</b> .....	<b>1</b>
A. PLANNING PURPOSE .....	1
<i>Albuquerque's Ranked Plans</i> .....	1
B. BACKGROUND AND HISTORY OF SYSTEM .....	2
1. <i>Previous Bikeway &amp; Trail Planning in Albuquerque</i> .....	2
2. <i>Early Accomplishments</i> .....	3
3. <i>Recent Accomplishments</i> .....	4
C. BIKEWAYS AND TRAILS BENEFITS .....	5
1. <i>Economic Benefits</i> .....	6
2. <i>Traffic Improvements</i> .....	7
3. <i>Social Equity in Mobility</i> .....	7
4. <i>Public Health Benefits</i> .....	7
5. <i>Environmental Benefits/Natural and Cultural Resource Protection</i> .....	8
6. <i>Quality of Life Benefits</i> .....	8
D. THE PLANNING PROCESS .....	9
1. <i>Public Involvement Summary</i> .....	9
2. <i>Data Collection &amp; Analysis</i> .....	10
E. USING THE PLAN .....	10
F. ACRONYMS .....	12
G. DEFINITIONS .....	13
<b>CHAPTER 2: PLANNING &amp; POLICY FRAMEWORK</b> .....	<b>18</b>
A. BIKEWAYS & TRAILS SYSTEM VISION, GOALS, AND POLICIES .....	18
1. <i>Vision</i> .....	18
2. <i>Goals &amp; Policies</i> .....	18
B. RELATIONSHIP TO OTHER PLANS .....	22
1. <i>Applicable City Plans, Regulations &amp; Guidance</i> .....	22
2. <i>Applicable Regional &amp; State Plans</i> .....	27
5. <i>Federal Policies and Programs</i> .....	29
<b>CHAPTER 3: EXISTING CONDITIONS &amp; CURRENT ISSUES</b> .....	<b>31</b>
A. CYCLIST & PEDESTRIAN NEEDS .....	31
1. <i>Types of Users</i> .....	31
2. <i>User Needs – Current Issues</i> .....	33
B. EXISTING FACILITIES .....	34
1. <i>Types of Existing Facilities</i> .....	35
2. <i>Existing Facility Enhancements – Current Issues</i> .....	42
C. BIKEWAY & TRAIL SYSTEM ANALYSIS .....	45
1. <i>Bikeway &amp; Trail System - Assets &amp; Challenges</i> .....	45
2. <i>System Use</i> .....	51
3. <i>On-Street Bicycle Facility Needs Assessment</i> .....	55
4. <i>Current Studies &amp; Programs</i> .....	57
5. <i>Bikeway &amp; Trail System – Current Issues</i> .....	59

# PART II: RECOMMENDATIONS

<b>CHAPTER 4: RECOMMENDED NETWORK</b> .....	<b>62</b>
A. FACILITY GAP ANALYSIS .....	62
1. Existing Bikeway & Trail Evaluation.....	62
2. System Gap Analysis .....	63
3. Gap Closure Measures.....	65
4. Steps in Addressing Bikeway & Trail System Gaps.....	69
5. Evaluation of Bikeway Connectivity – Link Connections and Gap Closures.....	71
B. PROPOSED BIKEWAY AND TRAIL FACILITIES.....	73
1. Full Build-Out of the Bikeways & Trails Facility Plan.....	76
2. High-Priority Projects.....	90
3. Estimated Costs.....	95
C. EXISTING FACILITY ENHANCEMENTS .....	96
1. Intersection and Crossing Improvements.....	96
2. Retrofitting Trails to Be Universally Accessible .....	100
3. Bollard Assessment & Remediation .....	100
4. Facility Upgrades.....	101
D. WAY-FINDING .....	103
1. Signage and Marking .....	103
2. Emergency Responders .....	103
<b>CHAPTER 5: RECOMMENDED PROGRAMS</b> .....	<b>104</b>
A. CURRENT PROGRAMS .....	104
1. City of Albuquerque Bicycling & Trail Programs.....	104
2. Partnerships & Programs to Encourage and Support .....	109
B. NEW PROGRAMS TO EXPAND OR INITIATE.....	114
<b>CHAPTER 6: IMPLEMENTATION STRATEGIES</b> .....	<b>121</b>
A. BIKEWAY & TRAIL FACILITY DEVELOPMENT APPROACH .....	121
1. Administrative Organization & Coordination.....	121
2. Bicycle & Trail Coordinator .....	123
3. Role & Structure of Advisory Committees.....	124
4. Policies for Bikeway & Trail Development.....	129
5. Procedures for Trail Design, Development, & Review .....	134
B. LEGISLATIVE RECOMMENDATIONS .....	137
1. New Mexico State Motor Vehicle Code.....	138
2. Traffic Code, Albuquerque Code of Ordinances.....	138
3. Zoning Code, Albuquerque Code of Ordinances.....	139
4. Albuquerque Development Process Manual (DPM).....	140
C. MAINTENANCE & OPERATIONS RECOMMENDATIONS.....	142
1. Trails Maintenance Practices.....	142
2. On-Street Bicycle Facilities Maintenance Considerations.....	146
3. Citizen Maintenance Requests.....	147
4. Spot Improvement Program .....	148
D. MONITORING & EVALUATION .....	150
1. Trail and Bikeway Counts .....	154
2. Crash Data Collection & Analysis.....	154
3. Survey.....	155
E. FUNDING.....	155
1. State and Local Sources .....	155
2. Local Sources .....	156
F. SUMMARY OF IMPLEMENTATION ACTIONS .....	156
<b>CHAPTER 7: DESIGN MANUAL</b> .....	<b>130165</b>

---

# LIST OF MAPS, TABLES & FIGURES

---

Table 1: Existing Bikeway and Trail Facilities over Time & Proposed Facilities.....	4
Table 2: Albuquerque and Albuquerque Metropolitan Area Population.....	31
Table 3: Characteristics of Short- and Long-Term Bicycle Parking.....	39
Table 4: Bicycle Commute Data for Albuquerque over Time.....	54
Table 5: 2012 Bicycle Commute Mode Share.....	54
Table 6: Infrastructure Project Evaluation Criteria.....	63
Table 7: High-Priority “Current Projects” .....	90
Table 8: High-Priority “Critical Links Projects” .....	93
Table 9: Full Build-Out Cost Estimate.....	96
Table 10: Implementation Matrix.....	157
Figure 1: MRCOG 2035 Long Range Bikeway System Map .....	25
Figure 2: Trail Etiquette Signs .....	30
Figure 3: 2014 Bicycle Map.....	31
Figure 4: Signage Examples .....	34
Figure 5: Opportunities and Constraints.....	45
Figure 6: Educational Campaign Example .....	53
Figure 7: Bicycle Route Signage .....	54
Figure 8: Diagram of Gap Types.....	60
Figure 9: Alternate Routing Issues (Source: Oregon Bicycle & Pedestrian Plan).....	64
Figure 10: Bikeway & Trail Gap Closure Analysis Procedure.....	67
Figure 11: Proposed & Existing Bikeways and Trails Map - NW.....	73
Figure 12: Proposed & Existing Bikeways and Trails Map - NE.....	75
Figure 13: Proposed & Existing Bikeways and Trails Map - SW.....	77
Figure 14: Proposed & Existing Bikeways and Trails Map - SE .....	79
Figure 15: Current Projects Map .....	81
Figure 16: Critical Links Map .....	83
Figure 15: Prototypical Multi-Lane Arterial Intersection Design.....	92

**Appendix A** – Full Report of Proposed Facilities

**Appendix B** – 50 Mile Activity Loop Executive Summary

**Appendix C** – ADA Field Survey, 1996

**Appendix D** – League of American Bicyclists (LAB) Report for Albuquerque, 2012

**Appendix E** – Bollard Study, 2014

**Appendix F** – Trail & Bikeway User Count, 2010

**Appendix G** –Public Input, 2010 and 2014

Appendix E.1 – Interviews

Appendix E.2 – Stakeholder Workshops

Appendix E.3 – Public Open House Meeting Report

**Appendix H** – Compilation of 2010 Bikeways Data

**Appendix D.1** – User Count Data

Appendix **H.1** – Crash Data

Appendix **H.2** – Online Survey

Appendix **H.3** – Bikeway Quality Index

Appendix **H.4** – Cycle Zone Analysis

Appendix **H.5** – Gap Closure Engineering Evaluations

Appendix **H.6** – End of Trip Facilities Analysis

---

# EXECUTIVE SUMMARY

---

The City of Albuquerque's bikeway and multi-use trail system is a combination of on-street facilities (bike routes, shared lanes, bike lanes, bicycle boulevards, and shoulders) and off-street facilities (paved multi-use trails, unpaved trails, and grade-separated crossings). The mileage of official bikeways and trail facilities in the City grew by almost 200% between the years 2000 and 2010 alone. As of 2014, there are over 620 miles of bikeways and trails, with approximately 55% on street bike facilities and 45% multi-use trails. Much of the increased service has been on the west side of the Rio Grande. Additionally, numerous on-going programs help to educate, encourage, and promote cycling and use of multi-use trails.

The purpose of this document is to combine and update the City's two bicycle and trail plans - the *Trails and Bikeways Facility Plan*, 1993, and the *Comprehensive On-Street Bicycle Plan*, 2000 - ~~which will to~~ help the City better manage the growth of the bikeways trails system and ~~ensure promote~~ a well-connected, enjoyable, and ~~safe comfortable safer~~ non-motorized transportation and recreation system.

## Vision

The City of Albuquerque envisions a system of bikeways and trails that connect throughout the city to support active transportation and recreation. The city envisions the bikeways and trails network to be an integral part of its system of Parks, Open Space and Trails, which is one of Albuquerque's most valuable assets and is an integral part of attracting economic growth. The bikeways and trails will allow people of all ages and abilities to experience the city using active transportation, such as walking, biking, or skating. The City aims to increase the numbers of shopping, dining, school, and recreational trips made via bikeways and trails in order to improve public health, air quality, congestion management, and quality of life for residents of Albuquerque.

*The City will provide access for cyclists, pedestrians, and trail users to all areas of Albuquerque to encourage cycling and walking as ~~a~~ viable transportation options and to provide recreation opportunities, which result in an improved quality of life in the Albuquerque Metropolitan Area.*

This Plan will foster the construction and preservation of bikeways and trails, strive for improved safety and improved connectivity; and encourage healthy, outdoor activity. The system will be implemented in partnership with multiple agencies and will be based on consensus and sensitivity to the diverse viewpoints within the community.

## Goals

1. Improve ~~and enhance cyclist the cycling~~ and pedestrian ~~safety experience opportunities~~.
2. Develop a continuous, interconnected, and comprehensive system of bikeways and trails.
3. Enhance maintenance of all bikeways and trails, ~~and improve maintenance strategies~~.
4. Increase use of the bikeway and trails network.
5. Increase public awareness and education related to bikeways and trails.
6. Recognize and leverage the bikeway and trail network as an integral part of economic development and quality of life in Albuquerque.
7. Streamline administrative practices and coordination.

## Needs Assessment

The City's bikeways and trails, ~~along with the~~ including grade-separated crossings, provide the City with a well-functioning recreation and non-motorized transportation system. However, the current system lacks continuity in some areas and has a number of barriers that are difficult to cross, such as the Rio Grande and major arterial streets. Another major challenge of the system is the number of improvements needed to remedy older facilities that ~~are deficient in relation to the~~ may not comply with current design criteria.

The Needs Assessment, found in Chapter 3 of this Plan, presents an overview of the needs of trail users and bicyclists in Albuquerque. This analysis provides a summary of trail and bikeway user volumes and behaviors; discusses public input gathered through an online survey; and ~~examines the cyclist safety environment by analyzing~~ analyzes reported bicycle crash data. Currently, no comparable data is collected for trail users specifically. Three GIS-based, geographic analytical tools were used to determine the quality and connectedness of the existing bikeway system. In total, three analytical methods were used to evaluate the existing bikeways and trails facilities, and five methods apply specifically to bicycle use. These methods and their findings are described further in Chapters 3 and 4.

~~The~~ is information gathered during needs assessment efforts was used in conjunction with field visits, input gathered at public meetings, stakeholder interviews, and analysis of the existing bikeways and multi-use trail system to form future project recommendations. Some of the data is being monitored and updated. ~~For~~ For example, MRCOG updates the bikeway and trail user count data on an ongoing basis; traffic crash data is updated by UNM. Adequately understanding user needs enables system planners and policy-makers to develop cost-effective solutions for improving the region's bikeway and trail system.

## Recommendations & Implementation Approach

The Bikeways & Trails Facility Plan provides three types of recommendations:

- **Proposed capital improvements:** ~~The bikeways and trail map guides future facility improvements. An implementation plan and design guidelines were developed to guide design and construction of future facilities, support current and new education and outreach programs, and to guide development of the proposed 28 new grade-separated crossings, 290 miles of new bikeways, 159 miles of new trails, and numerous intersection enhancements~~ Recommendations are also made for end-of-trip facilities, intersection improvements, and specific gap closures that were identified as priority projects. It is anticipated that a major portion of the multi-use trails capital funding will be allocated to existing trail renovation: for basic upkeep; for implementation construction of safety mobility and accessibility improvements; to address areas of high use/user conflicts; and in projects that result in more well-maintained trail corridors. Only projects within the City limits are proposed in this plan; future facilities that connect to the city are shown for context and continuity of analysis.
- **Programs:** The plan provides a review of existing programs to expand and continue, as well as new programs recommended for additional outreach, education, training, and awareness. To address advisory committees concerns related to the effectiveness of how the City Departments responsible for developing and managing the system coordinate with each other, with other jurisdictions and agencies, and effectively utilize public input, this plan suggests changes to improve organization of these activities.

- **Policy changes:** The plan proposes changes to adopted state and local policy to help improve safety and ~~the safety, and law~~ enforcement of laws relating to on-street bicycling facilities. This plan proposes design guidelines to address on-street facilities, multi-use trails, way-finding treatments, and end-of-trip facilities, as well as improved procedures for design review. Policy recommendations are made to incorporate improved maintenance of the facilities. ~~Design guidelines address on-street facilities, multi-use trails, way-finding treatments, and end-of-trip facilities.~~

To summarize the discussion and recommendations in the second part of this plan, an 'Implementation Matrix' was created. This matrix lists all of the actions that the City should undertake now and in the future to work towards achieving the goals and vision of this plan. Some of the actions are part of the ongoing work that the City does building and maintaining the bikeways and trails system. New programs and actions were classified as short-, mid- and long-term, depending on the urgency of need in combination with what may be feasible with current levels of staffing and funding.

The *Bikeways & Trails Facility Plan* concludes with a series of Technical Appendices, which are meant to preserve the record of the full analysis that went into developing this document, as well as other relevant studies. They include:

- Appendix A – Full Report of Proposed Facilities
- Appendix B – 50 Mile Activity Loop Executive Summary
- Appendix C – ADA Field Survey, 1996
- Appendix D – League of American Bicyclists (LAB) Report for Albuquerque, 2012
- Appendix E – Bollard Study, 2014
- Appendix F – Trail & Bikeway User Count Data, 2010
- Appendix G – Public Input, 2010 and 2014
- Appendix H – Compilation of 2010 Bikeways Data



---

# PART I: BACKGROUND & POLICIES

---

## **CHAPTER 1: INTRODUCTION**

### **A. Planning Purpose**

The impetus for this planning process was to update and unify the City’s two planning documents, *The Trails & Bikeways Facility Plan (TBFP)*, 1993 and the *Albuquerque Comprehensive On-Street Bicycle Plan (COSBP)*, 2000. By taking stock of current issues and the City’s approach to bikeways and trails, we will be able to better manage the growth of the bikeway and multi-use trail system; thus helping to **ensure** **promote** a well-connected, enjoyable and **safe efficient**, non-motorized transportation and recreation system throughout the metropolitan area.

The purpose of the plan is to assess the current system and to make recommendations for new facilities, administration processes, and education and outreach programs. The trail and bicycle network is part of Albuquerque’s system of Parks, Open Space and Trails (POST). This system is one of Albuquerque’s prime attractions, connecting residents and visitors to Albuquerque’s natural surroundings and providing the city a unique sense of place, while also providing the opportunity for healthy activities that many residents desire.

The bikeway and trail network is also a part of the City’s multi-modal transportation system. Much of the funding that the City has allocated for bikeways and trails comes as part of a ¼-cent transportation tax and as a component of other transportation improvement projects. Incorporating bikeways and trails as an integral part of the transportation system is consistent with federal transportation policies that aim for a balanced, multi-modal system. Integrating bikeways on a variety of road types provides direct connections for those who rely on bicycling or walking as their mode of transit to commute, shop, or recreate.

This Rank II *Facility Plan* will guide the City-wide development of Albuquerque’s bikeways and trails system to provide healthy and sustainable options for transportation and recreation, connections to nature, access to goods and services, and local economic development stimulus.

### **Albuquerque’s Ranked Plans**

The City of Albuquerque uses a system of ranked plans, starting with the Rank I *Albuquerque/Bernalillo County Comprehensive Plan*, which sets the vision, goals, and overall policies from a City-wide perspective. There are also lower-ranked plans that must comply with the intent, policies, and goals of higher-ranked plans. Rank II Plans, including area plans (such as the *West Side Strategic Plan*) or facility plans (such as the *Arroyos Facility Plan*), are exclusively policy documents that provide more detail and give more direction about large but distinct areas or facilities within Albuquerque. Rank III Plans provide the most detailed guidance for an area, and often include zoning customized to meet the goals of specific areas. The plans should be internally consistent and consistent within the ranking hierarchy.

## B. Background and History of System

### 1. Previous Bikeway & Trail Planning in Albuquerque

In 1972, the City began work on its bicycle network. A team effort involving an ad hoc Bikeway Advisory Committee and the City of Albuquerque Planning Department developed *The Bikeway Study*, published in March 1974. The total proposed network originally targeted for completion in 1978 has yet to be realized. With a mature system of 620 miles of facilities, the fact that some of these early envisioned routes have not yet been completed speaks to the challenges in developing the system.

*The Bikeway Study* led to adoption of the *Bikeways Master Plan*, which establishes policy regarding bikeways in the Albuquerque Metropolitan Planning Area. A permanent Bikeway Subcommittee of the Environmental Planning Commission was created to advise the City on implementation of the Plan recommendations. These efforts were jointly adopted by the City and County. The bicycle subcommittee eventually became the current Greater Albuquerque Bicycling Advisory Committee (GABAC).

Since 1974, various plans and documents, including the *Facility Plan for Arroyos*, the *Facility Plan for Major Public Open Space* and several *Arroyo Corridor Plans*, have addressed different aspects of trail development, such as location, character, and even design. ~~This study~~ *The Bikeway Study* came at a crucial point in time as it helped Albuquerque acquire trail right-of-way (ROW) at a time when it was either free or very inexpensive. Now that most of the city has built out, the cost for ROW can be expensive and many times physically limiting.

A more recent planning effort was undertaken by the City Planning Department, which resulted in the *Trails & Bikeways Facility Plan*, completed in 1993. The Greater Albuquerque Recreational Trails Committee (GARTC) was established to help with the development of this plan. This plan established long-range policies for off-street trails and bicycle facilities within the Albuquerque Metropolitan Planning Area and was adopted by both the City and Bernalillo County. A proposed trail system that serves both recreational and commuting purposes was envisioned. The plan recommended the creation of two positions, a Bicycle/Pedestrian Coordinator in the Department of Municipal Development and a Trails Coordinator in the Parks & Recreation Department to oversee the development of on-street and off-street bikeways. ~~Both of these positions were created and are staffed to this day.~~ There are currently positions in each department dedicated to Bikeways & Trails Planning and Project Management.

At the time the *Trails & Bikeways Facility Plan* was adopted, there were 39 miles of paved trails. Staffing for the planning and implementation of the trail and bicycle network has remained stagnant or arguably reduced, while the size of the network has quadrupled. This is perhaps an indicator of the





growing pains the managers of the system and users of the system are currently grappling with.

In late 1996, the Department of Municipal Development initiated the *Albuquerque Comprehensive On-Street Bicycle Plan*, based on a recommendation in the *Trails & Bikeways Facility Plan* to investigate on-street bikeways more closely. A steering committee was created consisting of members from bicycle advisory and advocacy groups, public agencies, and other parties. The *Albuquerque Comprehensive On-Street Bikeway Plan* was adopted in 2000. It includes goals and policies, funding strategies, design standards, recommended facilities, and an implementation plan. Recommended elements of this study are currently being implemented as funding becomes available.

~~GABAC and GARTC were originally City/County committees. Each citizen committee was GABAC and GARTC were established by City ordinance and are charged with representing cyclists, equestrians, and pedestrians and advising governmental agencies on planning, projects, and programs affecting bicyclists and other trail users. Though they both include members representing unincorporated areas of city, Bernalillo County does not formally participate in the activities of the committees and will not jointly adopt the Bikeways and Trails Facility Plan. County trail and bikeway facilities are administered by the Bernalillo County Pedestrian and Bicyclist Safety Action Plan, adopted in 2012. This Plan seeks to coordinate new facility connections with those proposed by Bernalillo County. The County has withdrawn its participation with the advisory groups and adoption of the Trails & Bikeways Facility Plan. The reason given was that the groups focused almost exclusively on urban, paved trails, which was not what the County was working on, and their adoption of the Bernalillo County Bicycle & Pedestrian Safety Action Plan.~~

## 2. Early Accomplishments

~~For many years, When first constructed in the 1970s,~~ the Paseo del Bosque Trail, also known as “the Bosque Trail,” went from just south of the Zoo to the Rio Grande Nature Center (4.85 miles). ~~With extensions north and south~~ Subsequent expansions north and south made it possible for trail users to, ~~trail users can now~~ travel over 16 miles without encountering an at-grade intersection, ~~making this and this trail has become~~ the most heavily used trail in the City. The second most frequently used trail for cyclists is the combined Paseo del Nordeste and the North Diversion Channel Trails. The original Paseo del Nordeste Trail started at the University of New Mexico, went north to the Hahn Arroyo, and then east to Pennsylvania Street.

Since the North Diversion Channel Trail was completed and connects to the trail along Paseo del Norte, this has become part of a popular north-south trail, making connections to the Paseo del Bosque Trail and the Paseo del Nordeste with minimal at-grade crossings. AMAFCA has worked closely with the City on the trails using the channel and other AMAFCA rights-of-way. These trails carry regional cycling traffic, not just local traffic. Tramway Trail was originally developed in the early 1980s and has undergone multiple renovations. It was extended to the north by Bernalillo County and the NMDOT has played a strong role in its development and maintenance. It is now approximately 8.5 miles long and is another of the region’s most popular trails. See **Figure 3: 2014 Bike Map**, page 28, and **Figure 10: Existing Facilities Map**, page 64.

### Recent Accomplishments

Since 2007

- Over \$10 million in bikeways and path improvements
- 3 bike boulevards
- Gail Ryba bike and pedestrian bridge over ~~the~~ Rio Grande river
- Bear Canyon Arroyo bike and pedestrian bridge over I-25

### 3. Recent Accomplishments

Since 1993, there have been major shifts in federal policies and requirements for multi-modal transportation accommodations. See the discussion in **Chapter 2.B.5, Federal Policies and Programs** for more information. At the local level, the Mid-Region Council of Governments (MRCOG) has implemented these policies through its Project Prioritization Process and allocation of NMDOT funds to local jurisdictions. The City has adopted various new funding initiatives, such as the quality of life ¼-cent gross receipts tax, which earmarked a portion for trails, followed by the current ¼-cent transportation tax.

In the past several years, the City has constructed over \$10 million dollars in bikeway and path improvements, new facilities, and system upgrades. Part of this large expenditure was made possible by the American Recovery and Reinvestment Act of 2009 (ARRA), which funded “shovel ready” projects across the nation. These improvements have been focused on bridging major barriers and providing grade-separated crossings to reduce trail user/vehicle interactions and improve the safety security efficiency of the North Diversion Channel Trail.

In 2007, the City began construction of three bicycle boulevards, which provide an enhanced bicycle connection along Mountain Rd., 14<sup>th</sup> Street, and Silver Ave., which will ultimately connect the Rio Grande Paseo del Bosque Trail to San Mateo Blvd. In 2010, the City completed the Gail Ryba bicycle and pedestrian bridge across the Rio Grande just north of I-40. At this time, the City also repaved the City portion of the popular 16-mile-long Paseo del Bosque Trail, which had become rife with large pavement cracks. In 2012, four new underpasses were built along the North Diversion Channel, creating a second, nearly uninterrupted north-south trail route across the City. In 2013, the Bear Canyon Arroyo Bridge was completed, connecting the east and west sides of I-25 for non-motorized travel.

The mileage of official bikeways and trail facilities **within the City boundary** grew by almost 200% between 2000 and 2010 (see Table 1). From 2010 to the 2014, it has grown another 10%. This period also saw significant upgrades in grade-separated crossings and pavement maintenance as described above. This plan proposes projects that would more than double the current mileage of bikeways and trails. The intent of many of these new facilities is to increase continuity of the existing system by connecting gaps and bridging obstacles.

**Table 1: Existing Bikeway and Trail Facilities over Time & Proposed Facilities**

Bikeways & Trails	1974	1993	2000	2010	2014	Proposed	Proposed Full Build-Out
Multi-Use Trails	0	39	55	161	154	<u>117</u>	<u>271</u>
Unpaved Trails	-	-	-	-	49	<u>38</u>	<u>87</u>
Bike Boulevards	0	0	0	6	6	<u>17</u>	<u>23</u>
Bike Lanes	0	24	48	170	197	<u>198</u>	<u>395</u>
Bike Routes	0	0	56	134	115	<u>76</u>	<u>191</u>
<b>Total System Length</b>	<b>0</b>	<b>63</b>	<b>159</b>	<b>471</b>	<b>520*</b>	<b><u>412</u></b>	<b><u>880</u></b>
Total System (incl. unpaved)	-	-	-	-	620	<u>449</u>	<u>967</u>
Grade-Separated Crossings	0	10	15	26	31	<u>25</u>	<u>61</u>

- No data exists for these facilities in the years shown.
- \* The total system length in 2014 excludes unpaved trails, because they were not considered part of the total in previous plans. This needs to be done to compare “apples to apples” over time. There are approximately 50 more miles of unpaved trails managed by [the](#) Open Space [Division](#) that are outside the City limits.

On-going education and encouragement programs have been coordinated by the Department of Municipal Development and the Parks and Recreation Department. These recent improvements are in line with the present vision and goals of improving the ~~safety and~~ quality of the facilities and addressing specific facility gaps, in addition to focusing solely on increasing the extent of the system.

The City was presented a bronze level Bicycle-Friendly Community award from the League of American Cyclists in 2005 – a significant achievement for a first-time submittal. This recognition is a direct indication that the City is proceeding in the right direction with its development of bicycle facilities.

### **Other Jurisdictions’s Planning Efforts**

In addition to the City of Albuquerque, the State of New Mexico and the Mid-Region Council of Governments (MRCOG), and Bernalillo County have been active in bicycle and trail planning. In 2012, Bernalillo County adopted the *Pedestrian and Bicycle Safety Action Plan*, which identifies pedestrian and bicycle safety issues in the County and prioritizes projects to address the problems.

The Long Range Bikeway System (LRBS), presented in Figure 1, page 19, is part of the *2035 Metropolitan Transportation Plan* long-range transportation plan for the metropolitan area. Opportunities to update the LRBS are provided every ~~five-four~~ years through the MRCOG transportation planning process. The LRBS is included in the Transportation Program, which is reviewed and approved annually by elected officials, including Bernalillo County, Albuquerque, and Rio Rancho.

At the state level, the New Mexico Bicycle-Pedestrian-Equestrian Transportation Plan was completed in 1996. This plan provides goals, recommended actions, and planning and design guidelines to improve and accommodate non-motorized transportation modes. The NM Department of Transportation is currently working on the Statewide Long-Range Multimodal Transportation Plan (SLRP), which sets the vision for how New Mexico’s transportation system supports the well-being of our community now and in the future.

## **C. Bikeways and Trails Benefits**

Recent years have seen a nationwide trend toward the increased development and use of bikeways and trails for both recreation and transportation. Bikeways and trails provide communities with myriad benefits, including improved public health ~~and safety and safety~~, natural and cultural resource protection, environmental quality improvements, and economic growth.

Cycling and trail use is important to Albuquerque’s future due to its potential to address several interrelated challenges, including traffic, air quality, and public health. By planning a metropolitan area that is more accessible to non-motorized transportation, practitioners can affect all of these areas, which collectively can have a profound influence on existing and future quality of life in Albuquerque. As the *State Bicycle-Pedestrian-Equestrian Advisory Plan* states, walking and bicycling are already “significant modes of transportation in New Mexico.” Significant opportunities and reasons remain to expand the non-motorized transportation system and improve the quality of the user experience. Improving active transport

can achieve planning objectives including economic development, reduced traffic and parking congestion, energy consumption and pollution emissions, improved public health outcomes, and more compact development.

## 1. Economic Benefits

There are many positive economic benefits associated with bikeway and trail development. Bikeway and trail use reduces costs associated with vehicle use. **Commuting by bicycle costs, on average, less than half as much as driving** when all internal and external costs, including travel time, maintenance of infrastructure, environmental impacts and ownership expenses, are considered. According to AAA, the average annual cost to own and operate a motor vehicle is around \$9,000 per year in 2012. With robust transportation facilities for non-motorized travel, combined with transit, families may be able to get by with fewer cars per household.

A significant economic benefit of increased cycling is a reduction in motor vehicle traffic congestion, which has estimated annual congestion costs at over \$100 billion nationally. These costs result from lost productivity while stopped or slowed in traffic. **Each trip taken by walking or cycling is one fewer vehicle contributing to congestion and environmental pollution.** The economic impacts of traffic congestion also affect the business community through slower delivery times, diminished employee morale, and an inability of patrons to easily access businesses.

Studies show that walking, hiking, or biking a few times a week can **improve a person's health and reduce healthcare costs.** A cost-benefit analysis of using bike/pedestrian trails in Lincoln, Nebraska to reduce health care costs associated with inactivity showed that for every \$1 investment in trails for physical activity led to \$2.94 in direct medical cost reduction. Another study reported that those who exercise regularly “filed 14% fewer health claims, spent 30% fewer days in the hospital, and had 41% fewer claims greater than \$5,000” (Greenways, Inc., p. 14). Surveys indicate far fewer medical bills, lower insurance reimbursements, and fewer hospital stays by people who regularly use trails for transportation or recreation.

Trails build strong communities and are a **valuable amenity for neighborhoods.** According to a National Association of Homebuilders study cited by the *New York Times*, trails are the number one amenity potential homebuyers look for when they are considering moving into a new neighborhood. Homes near trails are easier to sell, and homeowners see a direct correlation between trails and positive impact on quality of life. Trails translate into higher housing values. Trails revitalize neighborhoods; new houses and businesses take advantage of locations adjacent to trails.

Finally, **bikeways and trails support tourism** by providing additional destinations and opportunities for visitors, who patronize nearby motels, bed and breakfasts, cafes, or shops. Cities with well-developed cycling and trail infrastructure have become destinations in themselves – look at Portland, OR; Davis, CA; Sedona, AZ; Boulder, CO; Ketchum, ID; San Antonio, TX; and even Manhattan, NY. These places have branded themselves as bike-friendly vacation locations. Albuquerque could benefit from increased revenues by attracting active or sport tourism. Local businesses selling bicycles, biking gear, walking and hiking shoes, and equestrian gear also stand to benefit from increased demand for their products.

Trails build local businesses; bicycle tourism is a growing segment of the tourism market benefiting businesses that are well connected to trails. [Several recent studies have concluded that people walking and bicycling spend more money locally and help to support local economy.](#) “Bicycle Friendly Districts”

is a new concept, started in Long Beach, CA, that is focused on improving bicycle facilities in select districts that have neighborhood and business support in order to build community, increase physical activity, and make streets less congested.

## **2. Traffic-Roadway Safety Improvements**

Roadway improvements ~~to that aimed at~~ increased bicycle ~~safety utilization safety~~ and attractiveness ~~can~~ also enhance motorists' ~~safety experience and safety~~ as well. Bike lanes or bikeway shoulders minimize traffic flow impacts by providing bicyclists with a designated space and decrease degradation of the roadway edge, thereby increasing roadway life and decreasing roadway maintenance costs.

Vehicle speed differential is the primary cause in a large percentage of roadway crashes and a deterrent to potential cyclists. A traffic calming approach being used successfully across the country is the striping of bike lanes to create narrower vehicular travel lanes. For cyclists, this approach serves the more important benefit of creating wider ~~and safer~~ non-motorized travel lanes.

[There is evidence that the more people walk and bicycle the safer it becomes to walk and bicycle. This is related to goals of both safety and increasing the number of users in the network \(Safety in Numbers, 2003\).](#)

## **3. Social Equity in Mobility**

According to the U.S. Census, nearly one-third of Americans do not drive — this includes children under 16, about 20% of residents over 65, and other residents over 16 that cannot afford or choose not to own a motor vehicle. Also included in this user-base are people that own cars but choose to walk or bike and people that would like to walk and bike but feel that significant barriers exist (e.g., physical barriers such as missing facilities or perceived barriers such as a lack of time). [Safe-Alternative](#) options for transportation, mobility, and recreation should be provided for all residents and visitors to the City.

## **4. Public Health Benefits**

Regular physical activity has a beneficial impact on health through its role of prevention of various diseases and health conditions and of protection against injury and disability.

In recent years, public health professionals and urban planners have become increasingly aware that the **impacts of motor vehicles on public health extend far beyond asthma and other respiratory conditions caused by air pollution**. There is a much deeper understanding of the connection between the lack of physical activity resulting from auto-oriented community designs and various health-related problems such as obesity and other chronic diseases. Although diet and genetic predisposition contribute to these conditions, physical inactivity is now widely understood to play a significant role in the most common chronic diseases in the US, including coronary heart disease, stroke, and Type II diabetes. In response to these trends, the public health profession has begun to advocate for the creation of walk-able and bike-able neighborhoods as one of the most effective ways to encourage active lifestyles. [Prescription Trails is one of the programs targeted at getting more people active \(see page 88\).](#) Studies show that 43% of people with [safe-dedicated](#) places to walk within ten minutes of home meet recommended daily activity levels, compared to only 27% of those without [safe-these](#) places to walk.

**Sixty-percent of the total New Mexican population is considered overweight or obese.** Data collected by the Center for Disease Control (CDC) between 1995 and 2010 indicates that the percentage of New Mexican residents classified as obese has increased from the 10 - 14% range in 1995 to 25% in 2010. As



Albuquerque becomes more inviting to non-motorized transportation, residents will have more opportunities to exercise, ideally resulting in a higher proportion of residents achieving recommended daily activity levels.

**Physical activity is directly linked to our overall physical and mental health.** Even moderate levels of exercise have been shown to aid in weight control, the prevention of heart disease and certain cancers, and the alleviation of anxiety and depression. However, making the choice to exercise can be a difficult one. “Lack of time or access to convenient outlets for healthy transportation and recreation opportunities” is a commonly cited barrier to increasing physical activity (Rails to Trails Conservancy). One way to ensure adequate amounts of exercise is to choose active transportation for one or more of your weekly trips to work, the store, or social gatherings.

~~Safe, d~~Dedicated paths and bikeways encourage the use of non-motorized modes of transportation for everyday errands and commuting. This allows people to build physical activity into their daily routines, rather than having to carve out extra time for exercise alone. Additionally, attractive, outdoor settings can make exercise more enjoyable and trails can provide cost-effective exercise options when compared to gym or health club memberships.

Tangible benefits include an improved mental outlook and enhanced well-being. Walking and cycling as transportation modes are an ideal form of exercise to maintain or improve one’s health, which will eventually impact the national goal of reducing health care costs.

## **5. Environmental Benefits/Natural and Cultural Resource Protection**

Trail preservation and development have positive impacts on environmental health and resource conservation. The designation of trail corridors can be used as a tool for preserving important natural landscapes in the face of increased development. Trails can provide an attractive alternative to driving for daily activities within the City.

~~The development of safe upgraded t~~Trail and bikeways ~~facilities designed~~ for use in everyday commuting and errands can significantly reduce our consumption of fossil fuels and our emission of pollutants. Each time an Albuquerque driver chooses to walk or cycle, **one fewer motor vehicle trip is made**. It is the intent of this plan to increase the numbers of shopping, dining, school, and recreational trips made via multi-use bikeways and trails. Further, bicycling does not consume petroleum products, thereby conserving energy and reducing emissions.

Bicycling could have a significant impact on air quality by replacing motor vehicles for short trips of less than 5 miles. This represents trips that are less fuel-efficient and generate the highest emission rates per mile traveled. Transportation alternatives, including bicycling and walking, are viable solutions to reducing vehicle miles traveled and air quality impacts. Cumulatively, this pattern may reduce traffic in some neighborhoods, which would also improve air quality.

## **6. Quality of Life Benefits**

Corporate relocation evidence shows that quality of life of a community is an increasingly important factor in corporate relocation decisions and may be more important than purely business-related factors when it comes to attracting new businesses, particularly in the high-tech and service industries. St. Mary’s County in Maryland found over a ten year period that businesses that moved to the county

because of tax incentives tended to leave as soon as the incentives expired. However, businesses that moved to the county because of its quality of life remained to become long-term residents and taxpayers.

In the end, a more balanced and flexible transportation system will give greater choice and independence to more members of the community. Neighborhoods can experience reduced environmental and transportation impacts from traffic congestion. Like the motor vehicle, the bicycle provides personal mobility. **The public, of all ages, will feel safer-more comfortable and more are-at ease in using the transportation system, whether cycling or walking in their neighborhood, due to the traffic calming impacts of bikeways.** As more and more people use the streets and trails using a variety of transportation modes for a variety of purposes, the sense of community will be strengthened, pollution will be reduced for a healthier physical environment, and health care costs will be reduced.

An enhanced bikeways and trails system also provides more support to the compact urban forms, making infill development more desirable. Close-in infill developments become more viable due to the non-vehicular connectivity resulting from their locations, versus the tendency for residents on the periphery to be more compelled to use their vehicles.

## D. The Planning Process

Beginning in 2008, the City began an update of the two existing bicycle and trail plans with the intention of combining both documents to reflect a consolidated approach to developing and managing the bikeways and trail system. Both plan documents needed to be updated to address current conditions, goals, policies, issues, and future priorities. Gannett Fleming West and Alta Planning were selected as the consultant team for the effort. They completed an extensive amount of data collection and analysis that have informed the recommendations in this plan. A *Draft Bikeways & Trails Master Plan* was completed in 2011, but it needed a clearer implementation approach, and additional planning was needed to adequately address the trail system and recreational concerns.

In 2012, the City Parks & Recreation Department revised the draft to incorporate trail and recreation related concepts. In late 2013, the Planning Department began work to consolidate the previous planning efforts with updated research and analysis. Staff updated the plan to directly respond to public comments collected in the 2011 planning effort, and updated the vision, goals, and policies to reflect the concerns raised by the public, advisory groups, and agency interviews. An implementation plan and design guidelines were developed to guide design and construction of future facilities, support current and new education and outreach programs, and to guide development of the proposed ~~162825~~ new grade-separated crossings, ~~290281~~ miles of new bikeways, ~~162159155~~ miles of new trails, and numerous intersection enhancements.

### 1. Public Involvement Summary

In the initial data collection and analysis stages of this effort, the consultant team held **several public open house meetings, a stakeholder workshop, and user and agency interviews.** They



developed a project website with updates and draft materials as the project progressed. A survey was also administered to get targeted feedback about bicycle facility preferences and the needs and desires of cyclists in the City. City Staff have carefully reviewed these documents and used them to inform additional plan content and revisions reflected in this current plan. Over [5501,300](#) individual comments were received throughout this process. Additional information was gathered by staff by regularly attending both the GABAC and GARTC meetings. This public input was reviewed throughout the planning process to guide development of this *Bikeways & Trails Facility Plan*.

## 2. Data Collection & Analysis

Gannett Fleming West and Alta Planning completed a range of studies to better understand opportunities to improve our bikeway and trail system. They collected bikeway and trail user counts at 37 locations in 2010, which was compared to a smaller user count performed in 1997. A crash analysis was performed to understand the overall severity, where, and when reported collisions occurred. The planning and engineering studies – Cycle Zone Analysis, Bikeway Quality Index, the engineering gap analysis, StreetPlan, and public input – were used to develop the recommended facility improvements and programs. The detailed methodology and results from these analytic approaches is included as appendices; a summary of each approach and salient findings are included in **Chapter 3.C, Bikeway & Trail System Analysis**. The full report for each analysis is included as **Appendix C, Compilation of 2010 Bikeways Data**.

Additional work has gone into understanding and developing recommendations related to the way the City administers bikeways and trails, as well as how the advisory groups can be most effective. More recent work, such as DMD's Bollard Study, Parks and Recreation's Trail Design Guidelines, the Mayor's *ABQ the Plan: 50-Mile Activity Loop*, and newly adopted [NACTO](#), [AASHTO](#), and ITE guidance are incorporated.

The Facility Plan provides three types of recommendations:

- **Proposed capital improvements:** The bikeways and trail map guides future facility improvements. Recommendations are also made for end-of-trip facilities, intersection improvements, and specific gap closures that were identified as priority projects.
- **Programs:** The plan provides a review of existing programs to expand and continue, as well as new programs recommended for additional outreach, education, training, and awareness. The plan includes ongoing programs as well as periodic events and campaigns.
- **Policy changes & implementation actions:** The plan proposes changes to adopted state and local policy to [help](#) improve the [safety, safety](#), design, and law enforcement [of on](#) trails and bikeways. Policy recommendations are made to improve maintenance of the facilities. Design guidelines address on-street facilities, multi-use trails, intersection design, way-finding treatments, and end-of-trip facilities.

## E. Using the Plan

The information gathered throughout the planning process was used to update goals and policies (**Chapter 2**), identify the strengths and weaknesses of our current bikeway and trail system (**Chapter 3**), the recommended network (**Chapter 4**), recommended programs (**Chapter 5**), the implementation approach (**Chapter 6**), and the design standards (**Chapter 7**).



This plan provides guidelines for implementing new projects identified during the planning process in **Chapter 4: Recommended Network** and **Chapter 6: Implementation Strategies**. It also provides policies for developing paths and bikeways in newly developing areas and in areas that need improved quality facilities in **Chapter 2: Planning & Policy Framework**. When a portion of the City has been identified for new development or redevelopment, whether by public or private means, this plan and the updated facilities map should be consulted to identify the need for bikeways or trails to be incorporated into the improvements as well as design standards for bikeway and trail facilities.

General guidelines for the design of those facilities are provided in **Chapter 7, Design Manual**. Facilities should be developed in accordance with the goals and policies of this plan and designed to be consistent with the Design Manual and most recent AASHTO, ITE, AADAG, and/or NACTO guidelines. Doing so will help ensure that new facilities are consistent with the long-range goals of the City to support and promote bicycle and trail use as a transportation option, recreation opportunity, and enhancement of quality of life for all citizens.

The following section, **Chapter 1.F, Acronyms**, and **Chapter 1.G, Definitions**, provide a comprehensive list of terminology and definitions used in this plan.

[This plan proposes projects and programs that can be implemented over the next 50 years, at our current rates of funding for bikeways & trails activities. However, the plan recommends more frequent updates at 54 year intervals to allow the City to keep up with new best practices and to reflect our evolving understanding of the challenges facing the City in terms of walking and bicycling. The bicycle and trail maps and geodatabases should be updated as facilities are developed; the printed bike system map is updated annually.](#)

## F. Acronyms

<i>AADT</i>	Average Annual Daily Traffic
<i>AASHTO</i>	American Association of State Highway and Transportation Officials
<i>ADA</i>	Americans with Disabilities Act
<i>ADAAG</i>	ADA Accessibility Guidelines
<i>AMAFCA</i>	Albuquerque Metropolitan Arroyo Flood Control Authority
<i>APD</i>	Albuquerque Police Department
<u><i>B&amp;PSEP</i></u>	<u>Bicycle &amp; Pedestrian Safety Education Program (administered by P&amp;R)</u>
<i>BQI</i>	Bikeway Quality Index
<i>CZA</i>	Cycle Zone Analysis
<i>DMD</i>	Department of Municipal Development
<i>DRC</i>	Design Review Committee
<i>FHWA</i>	Federal Highway Administration
<i>GABAC</i>	Greater Albuquerque Bicycling Advisory Committee
<i>GARTC</i>	Greater Albuquerque Recreational Trails Committee
<i>ITE</i>	Institute of Transportation Engineers
<i>KAFB</i>	Kirtland Air Force Base
<i>LOS</i>	Level of Service
<u><i>MPOS</i></u>	<u>Major Public Open Space</u>
<i>MRCOG</i>	Mid-Region Council of Governments
<i>MRGCD</i>	Middle Rio Grande Conservancy District
<i>MTP</i>	Metropolitan Transportation Plan
<i>MUTCD</i>	Manual on Uniform Traffic Control Devices
<u><i>NACTO</i></u>	<u>National Association of City Transportation Officials</u>
<i>NMDOT</i>	New Mexico Department of Transportation
<u><i>OSD</i></u>	<u>Open Space Division</u>
<i>POST</i>	Parks, Open Space, and Trails
<i>ROW</i>	Right-of-way
<i>P &amp; R</i>	Parks and Recreation Department
<i>PROWAG</i>	Accessibility Guidelines for Pedestrian Facilities in the Public Right-of-Way
<i>TAP</i>	Transportation Alternatives Program
<u><i>TDM</i></u>	<u>Traffic Demand Management</u>
<i>TIP</i>	Transportation Improvement Programs

## G. Definitions

**Accessible** — describes a trail, or a portion thereof, which complies with the American National Standards Institute (ANSI) Guidelines and is accessible to people with disabilities.

**Accessway** — access routes between lots shall consist of a minimum 6-foot wide path in a 12-foot wide space, shall meet ADA standards as required by law, and shall prevent vehicle entry. Access routes shall have no blind spots and access route exits shall be clearly visible from all points along the route. Pedestrian access routes longer than 120 feet shall be a minimum of 18 feet wide.

**Activity Center** — location such as employment center, schools, downtown and uptown, entertainment, museums, etc. that tend to attract cyclist for education, recreation, shopping or employment.

**At-grade Crossing** — a junction where multi-use trail or sidewalk users cross a roadway at the same level as motor vehicle traffic, as opposed to a grade-separated crossing where users cross over or under the roadway using an overpass or underpass.

**Bicycle (Bike)** — a human-powered vehicle with two or more wheels designed to transport by the act of pedaling one or more persons seated on one or more saddle seats on its frame.

**Bike Boulevard** — a bike route that is designed to prioritize the through movement of bicycles while maintaining local access for motor vehicle travel. [This bikeway type is often used on neighborhood streets with good connectivity.](#) Traffic calming devices are used to control motor vehicle speeds and discourage vehicle through trips. These devices may include diverters, speed humps, traffic circles, or pocket parks which allow through access by bicycles. A bicycle boulevard may be constructed with wide curb lanes or with standard travel lanes and bike lanes. Bicycle boulevards should limit bicycle stops to one per quarter-mile or preferably one per half-mile spacing. [Also known as Neighborhood Greenways.](#)

~~**Bicycle Facilities** — the infrastructure that accommodates or encourages bicycling including bikeways, shared roadways not specifically designated for bicycle use, bicycle parking and storage facilities, and bicycle signal actuation hardware.~~

**Bicycle Network** — a system of public bicycle facilities that can be mapped and used by bicyclists for transportation and recreational purposes.

**Bike Route** — a segment of a system of bikeways designated on a roadway with appropriate directional and informational signing, with or without a specific bicycle route number, in accordance with the MUTCD. Bike routes are primarily located on local streets and low-volume, low-speed collector streets.

**Bike Lane** — a lane on the roadway that has been designated by striping, signing, and pavement markings for preferential or exclusive use by bicyclists. Bike lanes or paved shoulders are part of the standard arterial and collector cross-section. At signalized intersections, bike lanes should have bicycle-sensitive actuation capability such as loop detectors, video detection, curbside push buttons, or other detection devices approved by the City Traffic Engineer.

[Bike Lane, Buffered](#) — buffered bike lanes are conventional bicycle lanes paired with a designated buffer space separating the bicycle lane from the adjacent motor vehicle travel lane and/or parking lane.

[Bike Lane, Protected](#) — protected bike lanes have some sort of physical, stationary, vertical separation between moving motor vehicle traffic and the bike lane. Examples of vertical separation include plastic posts, bollards, curbs, planters, raised bumps or parked cars. Protected bike lanes can be at street level or

[raised, either to sidewalk level or a level in between street and sidewalk level. Paint alone does not create a protected bike lane. See \*Cycle Track\*](#)

**Bikeway** — a generic term for any road, street, path or way which in some manner is specifically designated for bicycle travel, regardless of whether such facilities are designed for the exclusive use of bicycles or are to be shared with other transportation modes.

**Bikeway Quality Index** — a metric developed to indicate the likely comfort of bicyclists riding on an existing bicycle facility. Bikeway Quality Index factors are variable depending on facility type but typically include surface quality and way-finding.

**Bulb-out** — a curb extension is a traffic calming measure, primarily used to extend the sidewalk, reducing the crossing distance and allowing pedestrians about to cross and approaching vehicle drivers to see each other when vehicles parked in a parking lane would otherwise block visibility.

**Chicane** — an artificial feature creating extra turns in a road, used to slow traffic [for safety](#).

**Crosswalk** — any portion of a roadway at an intersection or elsewhere distinctly indicated for pedestrian crossing by lines or other markings on the surface.

**Cycle Zone Analysis** — a zone-based system developed to analyze existing bicycling conditions. Zones consists of a more-or-less homogeneous cycling environment based on employment and population density, land use mix, road network density, connectivity, and topography.

[Cycle Track](#) — a cycle track is an exclusive bike facility that combines the user experience of a separated path with the on-street infrastructure of a conventional bike lane. A cycle track is physically separated from motor traffic and distinct from the sidewalk. See [Bike Lane, Protected](#)

**Directional or way-finding signs** — signs typically placed at road and bicycle path junctions (decision points) to guide bikeway users toward a destination or experience.

**Grade-separated crossing** — an overpass or underpass allowing multi-use trail users to cross a major roadway without motor vehicle conflict.

**Highway** — a road or thoroughfare, such as a street, boulevard, or parkway, which functions as a main route for any form of transport or travel and is available to the public for use.

**Loop detector** — a device placed in the pavement, real or virtual, at intersections to detect a vehicle or bicycle and trigger a signal to provide a green light for through traffic. They are also used to count bicyclists on multi-use trails.

[Major Public Open Space](#) — an integrated system of lands and waters that have been designated as such in the Comprehensive Plan. The lands and waters and interests therein have been or shall be acquired, developed, used and maintained to retain their natural character to benefit people throughout the metropolitan area by conserving resources related to the natural environment, providing opportunities for outdoor education and recreation or defining the boundaries of the urban environment.

**Medians** — the area in the center of the roadway that separates directional traffic. Medians may be painted and leveled with the surrounding roadway or raised using curb and gutter. Medians may include landscaping, concrete, striping or any combination thereof.

**Median Refuge** — an area within an island or median that is intended for pedestrians or cyclists to [wait safely away](#) [be separated](#) from travel lanes [to wait](#) for an opportunity to continue crossing the roadway.

**Midblock Crosswalk** — a legally established crosswalk that is not at an intersection.

**Multi-Use Trail** — see **Trail**

**Open Space Trail** — [a linear corridor within open space or linking open space to other facilities. Open space trails include open space arroyos and open space links.](#)

**Paved Trail** — a trail surfaced with asphalt, concrete, soil cement, or other hard, stabilized surface.

**Pavement Marking** — any marking on the surface of the pavement that gives directions to motorists and other road users in the proper use of the road. The MUTCD determines the standard marking in New Mexico for state and local use.

**Pedestrian** — someone who walks or journeys on foot; a walker.

**Pedestrian Hybrid Beacon** — [the pedestrian hybrid beacon \(also known as the High intensity Activated crossWalk \(or HAWK\)\) is a pedestrian-activated warning device located on the roadside or on mast arms over midblock pedestrian crossings. These are recognized by FHWA as “proven counter-measures” that improve safety.](#)

**Policy Goal** – [a broad statement of intent providing guidance for action.](#)

**Practical Uses** — [when the primary purpose is to get to a necessary destination, such as to work or school, or to perform essential errands such as shopping for food or going to a doctor’s appointment.](#)

**Principle** – [things we want to do, or avoid doing, as we develop and implement the plan. Principles define how we will go about “doing business” to achieve the plan’s goals.](#)

**Recreational Uses** — [when the primary purpose is for fun, fitness, sports training or family togetherness](#)

**Rectangular Rapid Flash Beacons** — [user-actuated amber LEDs that supplement warning signs at unsignalized intersections or mid-block crosswalks. They can be activated by pedestrians manually by a push button or passively by a pedestrian detection system. These are recognized by FHWA as “proven counter-measures” that improve safety.](#)

**Shared Roadway** — a shared roadway is any roadway that may be legally used by both motor vehicles and bicycles and is not specifically designated as a bikeway.

**Shared-use Path** — see **Trail**. Also defined by the Proposed Accessibility Guidelines for Pedestrian Facilities in the Public Right-of-Way (PROWAG) – a multi-use path designed primarily for use by bicyclists and pedestrians, including pedestrians with disabilities, for transportation and recreation purposes. Shared use paths are physically separated from motor vehicle traffic by a [buffer](#) or barrier and are either within the highway right of way or within an independent right-of-way.

**Sharrow (Shared Lane Marking)** — a pavement marking symbol that indicates an appropriate positioning of cyclist within a travel lane shared by both bicycle and motor vehicles. This is used in Albuquerque on low traffic volume streets, typically classified as collector or below.

**Shoulder Bikeways (Paved Shoulders)** — a bicycle facility located along uncurbed arterials and collectors. It consists of a smooth paved surface that covers all or part of the roadway shoulder. Shoulder bikeways, or paved shoulders, are similar to wide curb lanes on roadways with curb and gutter.

**Sidewalk** — the portion of a street or highway, beyond the curb or edge of roadway pavement, which is intended for use by pedestrians. Sidewalks are typically, but not always, curb-separated from the roadway and made of concrete, brick, asphalt, or other hard surface material.

**Single-track Trail** — a trail where users must generally travel in single file and is named not for the physical structure of the trail but rather for the user. Single track trails are typically 18-30 inches wide. Usually and almost always a soft-surface trail or unpaved natural surface trail. These trails are typically found on Major Public Open Space lands and sometimes referred to as mountain bike or hiking trails. They disturb less ground and can be easier to maintain due to their narrow width. The narrowness of the trail tends to immerse the user closer to nature than a wider trail or dirt road.

**Smart Trips** — any trip made by walking, bicycling, sharing a ride or riding the bus that replaces a drive-alone vehicle trip.

**Soft-surface Trail** — a soft-surface trail is typically built with the earthen materials on hand and no fill or other material is brought to the area of construction. See **Unpaved Trail, Single-Track Trail**

**StreetPlan** — a GIS-based street evaluation model used in this Plan that graphically shows where bike lanes or wide curb lanes can be provided based on existing roadway configuration.

**Traffic Demand Management Program** — a TDM Program is an institutional framework for implementing a set of TDM strategies. Such a program has stated goals, objectives, a budget, staff, and a clear relationship with stakeholders. It may be a division within a transportation or transit agency, an independent government agency, or a public/private partnership.

**Transportation Improvement Programs** — a capital improvement program developed cooperatively by local and state transportation entities. TIP projects are drawn from and consistent with a statewide rural long-range plan and include a list of multi-modal transportation (a connected transportation system that supports cars, bicycles, pedestrians, and public transit) projects. All regionally significant projects must be in the TIP regardless of intended funding source.

**Trail** — a separate pathway that is physically separated from motor vehicle traffic by a [buffer](#) or barrier and either within the highway right-of-way or within an independent right-of-way. It is designated by signs for use by non-motorized traffic only, including pedestrians, bicyclists, skaters, wheelchair users, joggers, other non-motorized users, and equestrians. Not all trails may accommodate all of these uses. Most trails are designed for two-way travel. Trails may be either hard-surface or soft-surface; or paved or unpaved. See also, **Paved Trail, Shared-use Path, Soft-surface Trail**

**Traffic Calming** — changes in street alignment, installation of barriers, and other physical measures employed to reduce traffic speeds and/or cut-through traffic volumes in [an effort to enhance neighborhood and street safety](#), [safety](#), livability, and other public purposes. Traffic Calming measures may include diverters, speed humps, traffic circles, or pocket parks which allow through access by bicycles.

**Traffic Control Devices** — Signs, signals, push buttons, or pavement markings whether permanent or temporary, placed on or adjacent to a travel way by authority of a public body having jurisdiction to regulate, warn, or guide traffic. MUTCD designates standards.

**Unpaved Trail** — an unsurfaced natural trail or trail surfaced with compacted earth, crusher fines, bark, or gravel. It is not surfaced with a hard, durable surface such as asphalt or Portland cement.

**Utilitarian Trips** — trips that are not primarily for recreational purposes, such as running errands.

**Way-finding** — signs, maps, and other graphic or audible methods used to convey location and directions to travelers.

**Wide Curb Lanes** —located on shared roadways with outside lane widths of 14 to 16 feet. Wide curb lanes are similar to shoulder bikeways, or paved shoulders, on roadways without curb and gutter.



# CHAPTER 2: PLANNING & POLICY FRAMEWORK

## **A. Bikeways & Trails System Vision, Goals, and Policies**

This section defines the vision statement, goals, and policies for the City’s bikeways and trails system. Plan objectives and action items/strategies, along with methods to measure success in implementing the Plan, are included in **Chapter 6, Implementation Strategies**. A project management team consisting of members from public agencies and plan development team members adapted the *Trails & Bikeways Facility Plan* and the *Albuquerque Comprehensive On-Street Bicycle Plan* goals and objectives to reflect current issues and concerns about the bikeway and trail system.

### **1. Vision**

The City of Albuquerque envisions a system of bikeways and trails that connect throughout the city to support active transportation and recreation. The city envisions the bikeways and trails network to be an integral part of its system of Parks, Open Space and Trails, which is one of Albuquerque’s most valuable assets and is an integral part of attracting economic growth. The bikeways and trails will allow people of all ages and abilities to experience the city using active transportation, such as walking, biking, or skating. The City aims to increase the numbers of shopping, dining, school, and recreational trips made via bikeways and trails in order to improve public health, air quality, congestion management, and quality of life for residents of Albuquerque.

*The City will provide access for cyclists, pedestrians, and trail users to all areas of Albuquerque to encourage cycling and walking as a viable transportation options and to provide recreation opportunities, which result in an improved quality of life in the Albuquerque Metropolitan Area.*

This Plan will foster the construction and preservation of bikeways and trails, ~~strive for improved safety and to reinforce bicycle and pedestrian rights to be in the roadway and on sidewalks or trails;~~ promotes improved connectivity; and encourage healthy, outdoor activity. The system will be implemented in partnership with multiple agencies and will be based on consensus and sensitivity to the diverse viewpoints within the community.

With over 620 miles of bikeways, paved trails, and unpaved trails already constructed, the City recognizes that improving the continuity, maintenance, and quality of existing routes should generally take precedence over investment in new routes.

### **2. Goals & Policies Principles**

The goals and ~~olicies-principles~~ section provides general guidance for the development of the bikeways & trails system. Goals are outcome statements that define what the City is trying to accomplish in its Bikeways & Trails system. Principles define how we will go about “doing business” to achieve the plan’s goals. The goals and principles are visionary in nature, and relatively long-term in time horizon. For more detailed implementation strategies and actions related to these goals, please see **Chapter 6, Implementation Strategies**, and in particular, **Section F, the Implementation Matrix**.

1. Improve ~~and enhance cyclist the cycling and pedestrian safety experience opportunities.~~
  - a. **Principle Policy:** Develop a legible and predictable trail and bikeway system through planning, design, and implementation of physical improvements.



- b. **PrinciplePolicy:** Provide engineering and multi-disciplinary staff reviews for new and reconstructed bicycle and pedestrian facilities, including in the project scoping phases.
- b.c. **PrinciplePolicy:** Study, pilot, test, and implement best practices and designs that have been found successful in other communities to respond to the rapidly changing state of bicycle and pedestrian practices. Implementation of this plan should allow flexibility to include new projects and techniques that are highly consistent with the plan goals.
- e.d. **PrinciplePolicy:** Improve the utility of trail and bikeway facilities through programmatic activities, such as facility audits and assessments, education, outreach, and maintenance practices.
- e.e. **PrinciplePolicy:** Provide a welcoming and comfortable environment for all travelers along roadways and trails, which encourages more legitimate users on these facilities to help reduce crime. Focus on providing convenience, comfort, and protection for hazard and injury.
- e.f. **PrinciplePolicy:** Balance the need to discourage unauthorized motorized vehicle access on trails with the need to provide the trail users a facility without unnecessary obstructions through application of the best practice guidance for bollard placement in the design guidelines.

## 2. Develop a continuous, interconnected, and comprehensive system of bikeways and trails.

- a. **PrinciplePolicy:** Develop, construct, and promote an integrated system of bikeways and trails, with facilities distributed City-wide. The metropolitan area-wide recreational and commuter bicycle and trail network should emphasize connections among Comprehensive Plan Activity Centers.
- a. **PrinciplePolicy:** Focus on achieving connectivity of the existing bikeway and trail system when planning and programming trail and bikeway improvements.
- b. **PrinciplePolicy:** Work toward addressing and improving challenging intersections and physical barriers, and consider pedestrian and bicycle movement in the planning stages for new or reconstructed facilities.
- c. **PrinciplePolicy:** Provide access to destinations, such as activity centers, schools, parks, Major Public Open Space, shopping areas, and employment areas, for pedestrians and cyclists as part of a multi-modal approach.
- d. **PrinciplePolicy:** Consider connections between transit and bicycle and pedestrian facilities and reduce barriers where possible.
- e. **PrinciplePolicy:** Reduce implementation costs by including bicycle facilities as appropriate in all new and rehabilitation street projects.
- f. **PrinciplePolicy:** Include parallel paths and safe-improve crossings for bicycles, pedestrians, and equestrians where appropriate in street and highway projects.
- g. **PrinciplePolicy:** Create a multi-purpose network of open areas and trail corridors along arroyos and appropriate ditches. Acquire, regulate, or appropriately manage trail corridors to protect natural features, views, drainage and other functions or to link other areas within the Major Public Open Space network.

**3. Enhance maintenance of all bikeways and trails, and improve maintenance strategies.**

- a. **PrinciplePolicy:** Develop maintenance practices appropriate for each facility type.
- b. **PrinciplePolicy:** Implement priority maintenance as appropriate for each facility type, including trail corridors and bikeways, based on the recommendations in Chapter 6.C, Maintenance and Operations.

**4. Increase use of the bikeway and trails network.**

a. **PrinciplePolicy:** Increase the number of people who walk and bicycle by aiming to attract new users and to encourage incidental users to walk and bicycle more frequently.

a.b. **PrinciplePolicy:** Support the development of an integrated bikeways and trails system that serves the interests and needs of transportation and recreation.

b.c. **PrinciplePolicy:** Support use of non-motorized infrastructure as part of everyday life for daily activities, and aim for a mode share of 5% of all trips by walking or biking.

e.d. **PrinciplePolicy:** Accommodate all types, ages, and abilities of users in a comfortable manner throughout the system, while recognizing that all modes of travel and/or level of user ability may not necessarily be accommodated on every road or trail.

d.e. **PrinciplePolicy:** Support the development of bikeways and trails as in integral part of the City's transportation infrastructure.

e.f. **PrinciplePolicy:** Facilitate and encourage commuter cycling and utilitarian trips by developing performance measures to better understand the impacts of programs and projects.

f.g. **PrinciplePolicy:** Reduce conflicts between vehicular traffic, cyclists, and trail users.

g.h. **PrinciplePolicy:** Reduce conflicts between different types of trail users.

h.i. **PrinciplePolicy:** Accommodate the following users in the trail system recognizing that not all can be accommodated on every trail: cyclists (including upright, recumbent, and children), pedestrians (including walkers, runners, people using wheelchairs, people with baby strollers, people walking dogs), skaters, equestrians, and people with disabilities.

i.j. **PrinciplePolicy:** Support the development of bikeways and trails as in integral part of the recreation Parks, Open Space, and Trails system (POST), including recreational loops, secondary trails, and neighborhood-scale connecting routes.

j.k. **PrinciplePolicy:** Connect the bikeways and trails network with public transit, providing flexibility and choice for travel options and enhancing recreational opportunities.

**5. Increase public awareness and education related to bikeways and trails.**

- a. **PrinciplePolicy:** Implement a comprehensive program to increase public awareness of bicycling and trail use and to encourage healthy living and active lifestyles through use of the City's trail and bikeway system.

- b. **PrinciplePolicy:** Educate bicyclists, pedestrians, and other trail users on safe and lawful facility use, user safety performance and legal, predictable behavior, including the rights and responsibilities of each mode of travel.
  - c. **PrinciplePolicy:** Educate motorists on the rights of pedestrians and cyclists.
6. **Recognize and leverage the bikeway and trail network as an integral part of economic development and quality of life in Albuquerque.**
- a. **PrinciplePolicy:** Plan, design, construct, operate, and maintain City roads to promote convenient access to all legal users of roads, streets, and highways in a manner that promotes efficient movement of people and goods whether by car, truck, transit, assistive device, foot, or bicycle.
  - a.b. **PrinciplePolicy:** Promote bikeway and trail use as a non-polluting, cost-effective, and healthy mode of transportation and recreation.
  - b.c. **PrinciplePolicy:** Promote pedestrian and cycling opportunities and integrate into development to foster pleasant non-motorized travel conditions.
  - e.d. **PrinciplePolicy:** Dedicate a local funding source for construction and maintenance of bikeways and trails. Establish specific budget line items to support the provision of on-street and off-street bicycle systems and programs.
  - d.e. **PrinciplePolicy:** Increase the attractiveness and activity along this system through enhanced streetscape and trail aesthetics, landscaping, and amenities along bikeways and trails where feasible.
  - e. ~~**Policy:** Plan, design, construct, operate, and maintain City roads to promote convenient access to all legal users of roads, streets, and highways in a manner that promotes efficient movement of people and goods whether by car, truck, transit, assistive device, foot, or bicycle.~~
  - f. **PrinciplePolicy:** Promote walking and bicycling as legitimate forms of transportation in all planning, design, and programming efforts.
7. **Streamline administrative practices and coordination.**
- a. **PrinciplePolicy:** Provide adequate staff to implement the *Bikeways & Trails Facility Plan* with appropriate office budgets to promote bicycling and trail use.
  - b. **PrinciplePolicy:** Foster ongoing coordination among critical departments within the City to communicate and coordinate activities related to design of bikeways and trails.
  - c. **PrinciplePolicy:** Organize and coordinate implementation of this Plan among City Departments and other agencies to produce well-designed facilities and a connected network of bikeways and trails that are safe comfortable and enjoyable for the public to use.
  - d. **PrinciplePolicy:** Coordinate with Bernalillo County, NMDOT, AMAFCA, MRGCD, and MRCOG and other local jurisdictions as appropriate regarding connectivity, design, implementation, and maintenance.
  - e. **PrinciplePolicy:** Develop and maintain databases useful for trail and bikeway planning, inventory, prioritization of improvements, and accidentcrash reduction.

- f. **PrinciplePolicy:** Coordinate with APD to develop and implement a traffic law education and enforcement program that teaches pedestrians, bicyclists, and motorists about relevant laws for each mode of travel.
- g. **PrinciplePolicy:** Create and support opportunities for public and user input and engagement into the bikeways and trail system. Advisory groups and/or ad hoc committees should support the City's efforts to implement these policies and this Plan.
- h. **PrinciplePolicy:** Regularly accommodate bicycles and pedestrians recognizing that not all facilities may be appropriate on every roadway. Bicycles and pedestrians should be considered in the planning of every road project and by all departments when setting policy and programs.

## B. Relationship to Other Plans

This section summarizes relevant documents and policies that regulate and establish a framework for bicycling and walking in Albuquerque. Plans and policies are considered relevant if they directly address bicycle or trail facilities or land-use patterns that directly affect non-motorized transportation. The chapter consists of the following sections:

**Existing Bicycle and Trail Plans** provides a summary of plans that have led to the current bike and trail facilities, policies, and programs in Albuquerque.

**City Plans and Policies** summarizes relevant Albuquerque plans and provides specific policies related to biking, walking, and riding in the City.

**Regional Plans** summarizes regional plans relevant to the *Bikeways & Trails Facility Plan*.

### 1. Applicable City Plans, Regulations & Guidance

#### Comprehensive Plan (2012)

The Rank I *Albuquerque/Bernalillo County Comprehensive Plan* sets forth goals and policies to guide future land use and development in the city/county. Based on the vision of the community, the plan establishes a long-range plan for growth in a coordinated and coherent urban form to best promote the needs of the city. The plan incorporates goals and policies that support bicycle and trail facilities in all three areas; Land Use, Environmental Protection and Heritage Conservation, and Community Resource Management. These Comprehensive Plan policies were reviewed by the project team, and reflected as appropriate through this Plan. This Plan is consistent with the policy direction set in the Comprehensive Plan.

#### Trails & Bikeways Facility Plan (1993, amended 1996)

The City of Albuquerque and the County of Bernalillo jointly adopted the Rank II *Bikeways & Trails Facility Plan* in 1993. This plan established long-range policies for off-street, multi-use trails, and bicycle facilities. The plan identified funding sources (implemented later) and recommended two new positions: a bicycle/pedestrian/trail coordinator in Public Works (now DMD) and a trail coordinator position (Parks).

**Recommended Facilities.** The *Trails & Bikeway Facility Plan* developed a hierarchy of trail types as well as design standards. Primary trails serve the regional transportation network and also provide secondary recreational benefits. Primary trails were hard surfaced trails that encouraged separation of



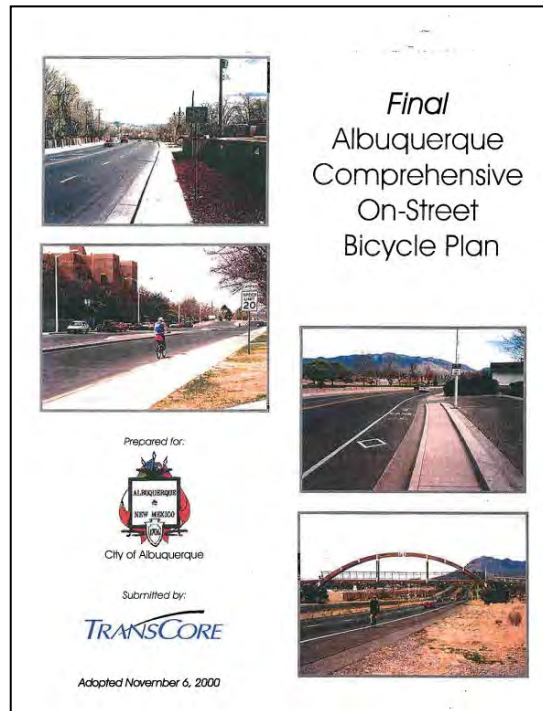
recreational trail users and commuter cyclists (though rarely accomplished due to right-of-way and budget constraints). Secondary trails provided access to the primary trails and could be either hard- or soft-surfaced trails. Finally, the Plan identified Trail Study Corridors with desirable trail connections but no proposed alignment. The *Trails & Bikeway Facility Plan* incorporated alignments proposed in the Rank II *Facility Plan for Arroyos* and Rank III *Arroyo Corridor Plans*. It also identified the need for an on-street bicycle facility plan (later completed) and a plan for preserving and utilizing the acequia system in the valley for a trail network (not accomplished).

### Comprehensive On-Street Bicycle Plan (2000)

The Rank II *Albuquerque Comprehensive On-Street Bicycle Plan*, adopted in 2000, developed recommendations to establish a comprehensive on-street network in order to make cycling a viable transportation option. A comprehensive set of goals, objectives, and action items was developed to be met by 2020. These objectives are included in this plan in **Chapter 6.A.4, Policies for Bikeway & Trail Development**.

**Recommended Facilities.** The objective of the on-street networks was to provide an interconnected bikeway network with half-mile spacing connecting major employment/shopping sites, schools, parks, and off-street trails. The proposed network consists of 507 miles of bike routes, lanes and short segments of sidewalk trails. Seventy-two percent (72%) of the recommended bikeways are located on arterial and collector roadways. This high ratio reflects the intent of the on-street bicycle plan to provide direct commuter routes and responds to the desire to integrate non-motorized forms of transportation into our road network. It provides planning-level cost estimates for bikeway corridor projects and recommends a flexible improvement program to implement the proposed network.

**Programs and Policies.** Encouragement, education, and enforcement programs were recommended in the plan. These include updating and distributing the city bicycle maps, bicycling awareness programs, [grade-school safety curriculum](#), [youth and adult Bicycle and Pedestrian Safety Education Program](#), media campaigns, and employer incentives for alternative travel. In addition, the plan recommended updating the Albuquerque Comprehensive Zoning Code to include bicycle end-of trip facilities. In 2003, the City attempted to accomplish this goal by



updating the General Parking Regulations to increase the amount of required bicycle parking and establish guidelines for end-of-trip facilities (O-02-59). Ultimately, the Mayor vetoed the legislation because of its adverse impact on small businesses and suggested a higher threshold for the building size that would require end-of-trip facilities (EC-520).

### **Major Public Open Space Facility Plan (1999)**

Trails in Major Public Open Space are a major part of the overall network of trails including paved trails in Rio Grande State Park MPOS (Bosque Trail) and single tracks in Elena Gallegos Open Space.

There are two types of open space within the plan area, Major Public Open Space and “open space.” Major Public Open Space (MPOS) corresponds with the locations identified in the Albuquerque Bernalillo County Comprehensive Plan, the City of Albuquerque Major Public Open Space Facility Plan (jointly adopted by the City and County), and the Bernalillo County Parks, Open Space, and Trails Master Plan. Lower case “open space” examples include easements, privately maintained trails, recreational and educational facilities, utility facilities and corridors, water storage and drainage facilities, access easements and roadway and/or transit rights-of-way.

### **Facility Plan for Arroyos and Arroyo Corridor Plans (various years)**

In 1986, the City and Bernalillo County jointly adopted the Rank II *Facility Plan for Arroyos* to establish guidelines that “create a multi-purpose network of recreational trails and open space along arroyos.” The plan was also endorsed by the Albuquerque Metropolitan Arroyo Flood Control Authority (AMAFCA), an agency which is generally supportive of multiple uses of its facilities where compatible with the drainage function. Trail use of AMAFCA property is subservient to its drainage function and is controlled by revocable licenses approved by the Board of Directors to a public agency able to assume liability and responsibility.

**Recommended Facilities.** The plan grouped Arroyos in the Metropolitan area into one of three categories – Major Open Space Arroyos, Major Open Space Links, and Urban Recreational Arroyos – and ranked their priority for development. Trail development is specifically outlined for the Arroyos identified as Major Open Space Links and Urban Recreational Arroyos, while Major Open Space Arroyos are intended to remain in natural or semi-natural condition, with limited development of trails.

Major Open Space Links are scheduled for the development of arroyo corridor plans which will locate recreational trails forming continuous east/west linkages between peripheral Major Public Open Space. This Major Public Open Space includes the Sandia Foothills, the Manzano Foothills, and the West Mesa Escarpment, the Rio Grande Bosque and, in the South Valley, former oxbows of the Rio Grande located west of Coors Boulevard. Barriers such as major streets, I-25, and the North and South Diversion channels may require crossing structures placed at strategic locations to provide continuity to the trail system. Acquisition and maintenance of the public-right-of-way and/or easements associated with Major Open Space Links over-and-above that required for drainage purposes will be the responsibility of the City. Dedication of arroyo rights-of-way as open space or parks or the granting of recreational easements where appropriate, are the preferred method of acquisition. Channel treatments with Major Open Space Links may vary. The native landscaping of rights-of-way and/or easements associated with trails will comprise the unifying element along these arroyo corridors.

Major Open Space Arroyos are to remain in a natural or semi-natural condition with native vegetation and channel stabilization consisting primarily of naturalistic treatments such as ungrouped riprap and

[gabions. Tinted concrete or soil cement may be used in limited applications such as in low-flow channels or as needed to control erosion at points where developed runoff enters the arroyo. The existing open space characteristics of these arroyos will be preserved to the greatest extent feasible in order to provide visual and psychological relief from urbanization, and to protect the natural drainage process. Acquisition and maintenance of the public right-of-way associated with Major Open Space Arroyos over-and-above that required for drainage will be the responsibility of the City. Dedication of arroyo rights-of-way as open space or parks or the granting of recreational easements, where appropriate, are the preferred methods of acquisition.](#)

From a trails standpoint, Albuquerque's arroyos offer unique opportunities in that they are linear corridors that cross large areas of the city and are generally located away from major roadways with relatively few street crossings. The *Facility Plan for Arroyos* recognizes this opportunity and sets forth policies for providing joint use of the arroyo rights-of-way, combining recreational uses with their primary drainage function. The system envisioned in the *Facility Plan for Arroyos* is intended to address the needs of all types of trail users, including pedestrians, runners, equestrians, individuals with disabilities, and cyclists.

### **Area and Sector Development Plans (various years)**

Rank II area and many Rank III Sector Development Plans also propose various trails, sometimes in a general way, and at other times very specifically. These proposals have all been included in **Figure 11: Proposed and Existing Trails Map**, page 66.

### **Code of Ordinances (ROA 1994)**

Albuquerque has city ordinances related to bicycling and horseback riding that regulate both user behaviors as well as requirements for different facility types. Ordinances related to bikeways and trails are largely addressed in Chapter 8 Traffic Code. Articles 2 (Traffic Regulations) and 3 (Motorcyclists, bicycles and toy vehicles) contain laws pertaining to the ownership of a bicycle, proper riding skills, and bicycle equipment. Article 2 also contains laws related to pedestrian movement, including requirements to cross at right angles to the road, prohibiting crossing at locations other than signed crosswalks, and requiring use of sidewalks, tunnels, and overpasses where provided. Ordinances addressing proper horseback riding are identified in Chapter 8, Article 4: Animals.

### **Development Process Manual (2008)**

The purpose of the Development Process Manual (DPM) is to clarify the development process for City staff, property owners, developers and their agents, especially planners, architects and engineers. The DPM contains the City's design standards and is intended to successfully carry out the goals and policies of the Albuquerque/Bernalillo County Comprehensive Plan.

All new roads in Albuquerque must be designed to accommodate bicycles. **The DPM establishes pavement width standards for roadways and minimum widths for bicycle facilities.** Arterials require a six-foot minimum bike lane or five-foot paved shoulder bikeway for posted speeds of 35 mph or less; seven-foot bike lane or six-foot paved shoulder bikeway for posted speeds of 40 mph or greater. Collector streets require a minimum six-foot bike lane or four-foot paved shoulder bikeway. All major local roads must have a signed bicycle route without striped lines at minimum or a six-foot wide paved path within a minimum twelve-foot wide Pedestrian Access Route.

Bikeway & Trail Location Guidelines and Design Standards are presented in **Chapter 7, Design Manual**. The AASHTO *Guide for the Development of Bicycle Facilities, 2012* (the “Bike Guide”) serves as the principal resource for the location and design of on-street and multi-use trail facilities. In the evaluation of facilities, it should be considered whether the AASHTO or NACTO standards are more appropriate when there is conflict between the two guiding documents. When it comes to bikeways and trails in the developed urban portions of the city, the NACTO Urban Bikeway Design Guide shall be the governing document in the event of conflict with the AASHTO document, unless the project funding stipulates otherwise. There should be documentation of which standards were selected and why. DPM standards have not been updated to reflect the most recent version of the “Bike Guide.” The DPM provides specific design guidelines for on-street facilities including: bicycle lanes, paved shoulder bikeways, bicycle routes, wide curb lanes, and bicycle boulevards. It also outlines special provisions for bike lanes including design recommendations for dual right-turn lanes, free right turn lanes, crossing conflicts, and bikeway grades.

### **City of Albuquerque Decade Plan: Capital Improvement Program (2009)**

The City of Albuquerque Decade Plan documents the capital improvement projects for the City over a ten year period. Funding for the Capital Improvement Program comes from the General Obligation Bond Program, which is approved by the voters and is updated every two years. Bicycle and trail projects are funded through a number of City departments including Parks and Recreation, Department of Municipal Development, and Planning. **The Decade Plan is the primary instrument for setting priorities for each two year Capital Improvement Program cycle.** As such, efforts to rank and prioritize projects within this Plan would not be able to take into account the changing fiscal, political, and maintenance-driven factors that determine what is programmed by the City.



## 2. Applicable Regional & State Plans

### 2035 Metropolitan Transportation Plan for the Albuquerque Metropolitan Planning Area

Every four years the Mid-Region Metropolitan Planning Organization (MPO) updates the Metropolitan Transportation Plan (MTP). The purpose of the MTP is to guide the development of the transportation system for the AMPA. The 2035 MTP sets goals that will lead to the development of an integrated transportation system and includes recommendations aimed at relieving congestion, maintaining air quality, and improving quality of life. The MTP establishes bicycle facilities and trails as important elements in their transportation demand management strategy.

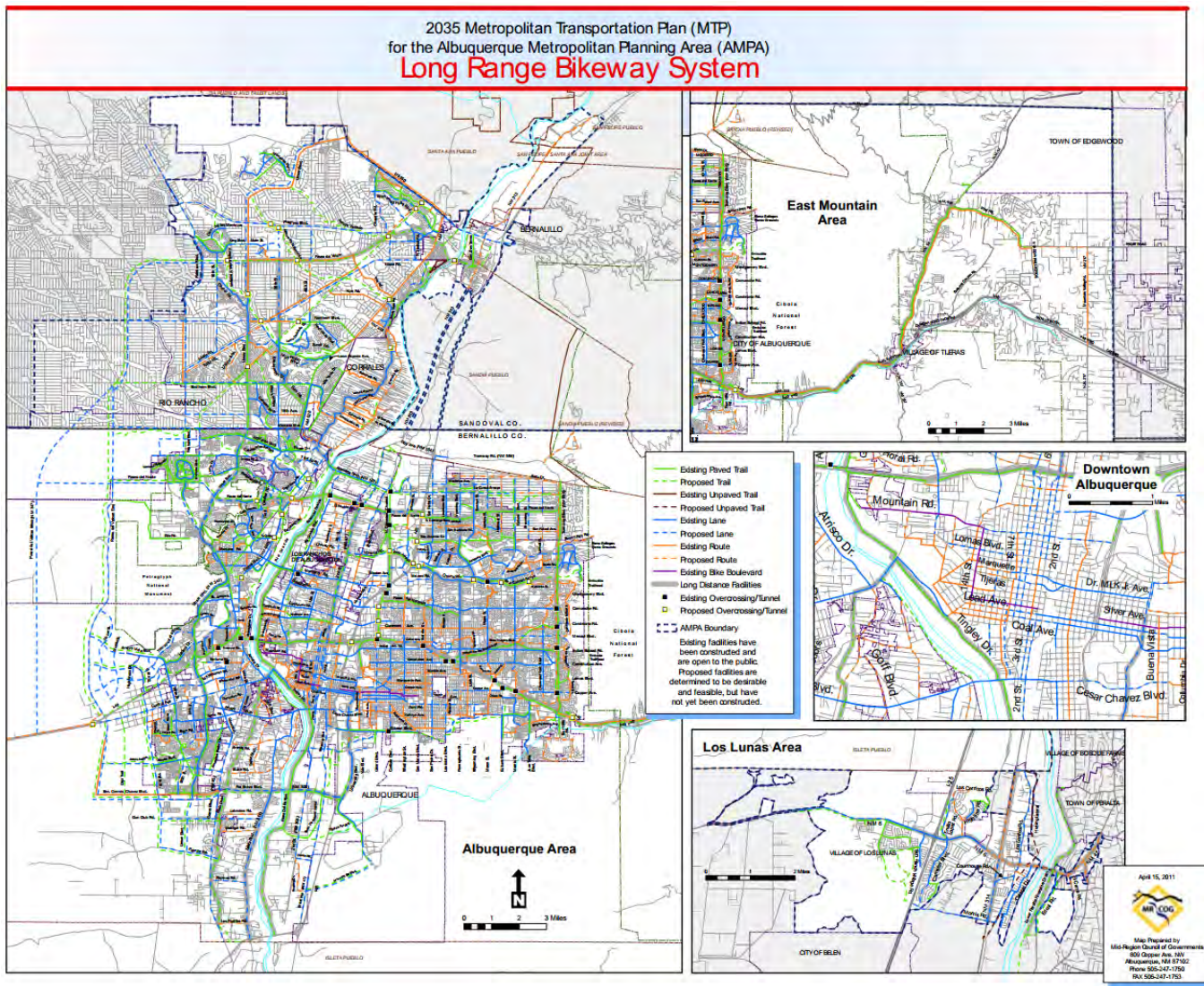
#### 2035 Metropolitan Transportation Plan – Key Bicycle & Pedestrian Policies

- Provide sufficient funding to develop and maintain efficient, high-quality pedestrian and bicycle circulation systems for safe, affordable, convenient, and comfortable travel between activity centers, activity corridors, residential neighborhoods, and public transit.
- Support opportunities to redevelop existing roadways as multi-modal facilities (complete streets).
- Promote the development of street patterns and designs that strongly support pedestrian and bicycle comfort, convenience, and safety and give high priority to development projects that closely integrate transportation and land use planning and design.
- Build safe facilities. Plan, design, and build bicycle and pedestrian facilities in accordance with the best practices described in the latest edition of the AASHTO Guide for the Development of Bicycle Facilities and the AASHTO Guide for the Planning, Design, and Operation of Pedestrian Facilities.
- Develop educational programs that encourage walking and bicycling; teach smart walking and bicycling skills; and teach motorists how to interact safely with pedestrians and bicyclists.
- Maintain strong and effective travel demand management and education programs to encourage, support, and enable shifts of person trips away from single-occupant vehicles and toward walking, bicycling, public transportation, ride-sharing, and work-at-home.
- Collect data and develop analytical methods to monitor and consistently evaluate the effectiveness of all projects and programs.

#### Long Range Bikeway System Plan-Map (2007-2011)

The Long Range Bikeway System Plan (LRBSP) maps existing and proposed bike facilities within the Albuquerque Metropolitan Planning Area (AMPA) and is adopted by the Metropolitan Transportation Board [through as part of](#) each 54-year Metropolitan Transportation Plan (MTP). The LRBSP is the guiding document with respect to planned bikeway location and character, [and it looks at transportation on the 20 year horizon](#). This map combines the on-street and off-street multi-use trails and is included in the annual AMPA Transportation Program. The map is periodically updated by the region in consultation with planners and elected officials from each jurisdiction. **Figure 1** shows the April 2011 map from the 2035 MTP. [The 2040 MTP is anticipated to be adopted in 2015.](#)

**Figure 1: MRCOG 2035 Long Range Bikeway System Map** (*Note: For illustrative purposes only. To see the full-size version of the Long Range Bikeway System map, please visit [www.mrcog-nm.gov](http://www.mrcog-nm.gov).*)



### New Mexico Bicycle / Pedestrian / Equestrian Advisory Plan (2009)

The New Mexico Bicycle/Pedestrian/Equestrian (BPE) Advisory Plan, developed for the New Mexico Department of Transportation (NMDOT) provides goals, guidance, and recommended design standards intended to improve the facilitation of non-motorized facilities in New Mexico. **State law requires that provisions for pedestrians, bicycles, and equestrians be properly considered in all NMDOT projects.** The BPE Advisory Plan provides recommendations specific to various functions within NMDOT. Recommendations for planning and programs; funding, engineering and design; and education, enforcement, and encouragement have a statewide scope. [The NMDOT is currently working on update to this document and establishing statewide criteria.](#)

### Statewide Transportation Improvement Program (STIP)

The New Mexico Department of Transportation (NMDOT) is responsible for developing the Statewide Transportation Improvement Program (STIP), the state’s capital improvement program for multi-modal

transportation improvement projects. The STIP prioritizes projects through a transportation planning process with local governments and develops a funding budget for a four-year period. In Fiscal Years 2010-2013, NMDOT allocated \$8.5 Million for bicycle and trail related projects in the City of Albuquerque. However, with recent changes to federal transportation programs and funding, the City is likely to see much less federal funding for bikeway and trail projects in the future. [The NMDOT will continue to include multi-modal enhancements into future roadway projects.](#)

## 5. Federal Policies and Programs

### Mainstreaming Non-Motorized Transportation

Bicyclists and pedestrians have the same origins and destinations as other transportation system users, and it is important for them to have safe and convenient access to jobs, services, recreation facilities, and neighborhoods.

Federal surface transportation law places a strong emphasis on creating a seamless transportation system that all users can enjoy and use efficiently and safely. Current federal transportation policy is to increase non-motorized transportation to at least 15% of all trips and to simultaneously reduce the number of non-motorized users killed or injured in traffic crashes by at least 10%. This shift in policy has given tremendous flexibility to States and MPOs to fund bicycle and pedestrian improvements from a wide variety of programs. Virtually all the major transportation funding programs can be used for bicycle and pedestrian related projects. Specifically, States and MPOs are encouraged to:

1. **Include bicycle and pedestrian improvements as an incidental part of larger projects.**
2. Review and use the most appropriate funding source for a particular project and not rely primarily on transportation enhancements. Many bicycle and pedestrian projects are more suitable for funding under the congestion mitigation and air quality improvement program or the surface transportation program.
3. **Exceed minimum design standards and requirements** of transportation agencies and local communities to create safe, attractive, sustainable, accessible, and convenient bicycling and walking networks.
4. **Consider walking and bicycling as equals with other transportation modes.** Because of the benefits they provide, transportation agencies should give the same priority to walking and bicycling as is given to other transportation modes. Walking and bicycling should not be an afterthought in roadway design.
5. **Ensure that there are transportation choices** for people of all ages and abilities, especially children. People who cannot or prefer not to drive should have safe and efficient transportation choices.
6. Collect data on walking and biking trips and set mode share targets for walking and bicycling and track them over time.
7. **Improve non-motorized facilities during maintenance projects.** Transportation agencies should find ways to make facility improvements for pedestrians and bicyclists during resurfacing and other maintenance projects.

Improving conditions and safety for bicycling and walking embodies the spirit and intent of Federal surface transportation law and policy to create an integrated, inter-modal transportation system that



provides travelers with a real choice of transportation modes. State and local agencies are challenged to work together cooperatively with transportation providers, user groups and the public to develop plans, programs, and projects that reflect this vision. For more information on these policies, see the 2010 U.S. Department of Transportation “Policy Statement on Bicycle and Pedestrian Accommodation.”

### **Moving Ahead for Progress in the 21st Century Act (MAP-21)**

In 2012, Congress passed the Moving Ahead for Progress in the 21<sup>st</sup> Century Act (MAP-21). MAP-21 requires that planning organizations incorporate bicycle and pedestrian facilities into all annual and long-range Transportation Improvement Programs. MAP-21 creates a streamlined, performance-based, and multimodal program to address the many challenges facing the U.S. transportation system. These challenges include improving safety, maintaining infrastructure condition, reducing traffic congestion, improving efficiency of the system and freight movement, protecting the environment, and reducing delays in project delivery. [MAP-21 established national performance goals for Federal Highway Programs:](#)

- [Safety—To achieve a significant reduction in traffic fatalities and serious injuries on all public roads.](#)
- [Infrastructure condition—To maintain the highway infrastructure asset system in a state of good repair.](#)
- [Congestion reduction—To achieve a significant reduction in congestion on the NHS.](#)
- [System reliability—To improve the efficiency of the surface transportation system.](#)
- [Freight movement and economic vitality—To improve the national freight network, strengthen the ability of rural communities to access national and international trade markets, and support regional economic development.](#)
- [Environmental sustainability—To enhance the performance of the transportation system while protecting and enhancing the natural environment.](#)
- [Reduced project delivery delays—To reduce project costs, promote jobs and the economy, and expedite the movement of people and goods by accelerating project completion through eliminating delays in the project development and delivery process, including reducing regulatory burdens and improving agencies’ work practices.](#)

Bicycle and pedestrian improvements are now addressed in the Transportation Alternatives Program (TAP), which is equal to 2% of the total amount authorized.

# CHAPTER 3: EXISTING CONDITIONS & CURRENT ISSUES

This section presents an overview of the existing bikeway and trail system and the needs of bicyclists and trail users in Albuquerque. Adequately identifying user needs enables bikeway and trail system planners and policy-makers to develop cost-effective solutions for improving the region’s bikeway and multi-use trail system. This section provides an overview of trail user and cyclist volumes and behaviors at many locations throughout the City (Section 3.C.2, System Use), discusses public input gathered through an online user survey (Section 3.C.3, Facility Needs Assessment), and examines [cyclist safety cycling conditions by analyzing](#) reported bicycle crash data (Section 3.C.3, Facility Needs Assessment).

**This information was used in conjunction with field visits, input gathered at public meetings, stakeholder interviews, and analysis of the existing bikeways and trail system to develop Part II, Plan Recommendations.**

## A. Cyclist & Pedestrian Needs

The 2035 Metropolitan Transportation Plan (MTP) and the Centers and Corridors element of Albuquerque’s Comprehensive Plan anticipate that Albuquerque’s future will include an increasing mix of uses and higher densities concentrated in mixed-use centers. The 2035 MTP anticipates that the City will accommodate a greater share of regional population and employment than it has to date. The predicted Albuquerque Metropolitan Planning Area population in 2025 is 1,093,490, which is an increase of 53.4 percent, or 380,752 people, compared to the 2000 Census.

As the Albuquerque continues to grow, the City needs to plan for a truly multi-modal transportation and recreation system that serves the needs of all residents. The city’s rapid growth is occurring west of the Rio Grande both in the northwest and southwest quadrant. Roughly half the people in New Mexico live in the Albuquerque area.

**Table 2: Albuquerque and Albuquerque Metropolitan Area Population**

Albuquerque Population		Metro Area Population (includes Bernalillo, Sandoval and Valencia counties)	
Year	Population Estimate	Year	Population Estimate
2000	448,607	2000	712,738
2006	507,789	2005	766,016
2010	535,239	2009	857,903
2012	55,419	2012	902,794

### 1. Types of Users

#### Pedestrians

This group includes all travel that is primarily foot-powered, including walkers, joggers, runners, and skaters. Pedestrians are typically looking for facilities that provide connections to destinations for utilitarian trips or for longer continuous facilities for exercise-related trips. Key facilities for pedestrians include travel-ways with a smooth travel surface and infrastructure [to that helps enhance safety utilizationsafety](#) at roadway crossings. The City also must provide adequate access and opportunities for individuals with disabilities to use the non-motorized bikeways and trails system facilities.

## Cyclists

The needs and preferences of cyclists vary depending on skill level, equipment, and/or trip purpose. For example, bicyclists who ride for recreational purposes may prefer scenic, winding trails, while cyclists who ride to work or for errands may prefer more direct routes and on-street bicycle facilities. However, this traditional stereotype of each facility type is increasingly becoming blurred. Commuters in Albuquerque often feel more comfortable and relaxed on trails, while the City has also seen dramatic increases of the number of people who will use streets to access recreational opportunities, including craft breweries, parks, and open space, or use the streets as recreational opportunities, such as bicycle scavenger hunts and group rides.

The needs and preferences of cyclists vary widely depending on skill level, equipment, and/or trip purpose. For example, some recreational cyclists may prefer scenic, winding paved trails and bike-friendly roadways, while others prefer unpaved, off-road trails that offer miles of uninterrupted riding without necessarily reaching a specific destination. Cyclists who ride to work, school or for errands may prefer more direct routes to activity centers and/or commercial districts provided by trails and on-street bicycle facilities. Providing for all users requires understanding their disparate needs.

### Advanced Users

Cyclists who use their bicycle for utilitarian trips (ones other than recreation)-Experienced cyclists may find that on-street facilities are the most functional facilities for bicycle transportation, whether for utility or recreation. This could be attributed to the more direct connections that streets can provide, as well as fewer conflicts between user types. Advanced cyclists have stated their preference for marked on-street bicycle lanes in numerous national surveys.



### Traffic Intolerant Adults, Beginning Cyclists, & Children

Child cyclists, seniors, and beginning adults are generally thought to prefer trails, because there is no vehicular traffic. Individuals who cannot afford to drive a car or who choose to live without a car may have preferences that are not as easily classified. Despite each individual user's comfort level, there is generally a portion of the trip that requires using the street system. As a city, we should strive to make each trip as safe and safe, comfortable, and efficient as possible by providing a connected network range of on- and off-street options across the city.

Many bicyclists – particularly less experienced riders – are far more comfortable riding on a busy street if it has a striped bike lane with painted markings. Part of the intent of this Plan is to encourage new riders, and providing future marked facilities such as bike lanes may be one way to accomplish that. It is also important to note that many advanced cyclists use Albuquerque's trail system due to its extensive length, mild curve radii overall, gentle slopes, and ease in reaching many parts of the City.

## Other Wheeled Trail Users

In addition to the primary user groups identified above, there are other types of trail users who have slightly different needs. This user group includes the following: skaters, including in-line and roller-skates, long skateboards, skateboards, and kick scooter users. Others include people with baby strollers and individuals in wheelchairs. These users tend to prefer a surface that is smooth without major cracks. They may be moving at a slower pace than other wheeled trail users, and therefore share some similarities with the needs of pedestrians.

## Equestrians

As with pedestrians and bicyclists, the needs of equestrians vary with experience and relative levels of urbanization and trail development. In areas of higher use, equestrians prefer facilities that provide adequate separation from other user types that may spook horses (e.g., cyclists or in-line skaters) and an unpaved trail.

## 2. User Needs – Current Issues

### Balancing the Needs of the Various Users/Conflict of Use

Each of these different user groups has slightly different needs and ways of using the same facilities. On trails there are conflicts between faster moving cyclists and pedestrians or equestrians, particularly with trails that are built to the *minimum* standard width. The Paseo del Bosque is a good example of a hugely popular trail with a variety of users. On streets there are conflicts between cyclists and motor vehicle drivers, again, particularly on facilities that are narrow with little separation between users.

The City aims to ~~address~~ lessen these user conflicts in three ways: 1) develop new facilities to meet the minimum design standards and guidelines needed to improve ~~the safety of~~ the trail or bikeway, 2) inventory, evaluate, and then retrofit design enhancements for facilities that do not meet the minimum standards or have high volumes of users, for example adding wide shoulders or a parallel soft-surface path, and 3) educate and promote awareness of trail etiquette and the types of accommodations that are required when there are high volumes of users, such as slower speeds and more communication between users. Current problem areas on multi-use trails have signage and graphics indicating who is supposed to yield to whom.

### Figure 2: Trail Etiquette Signs





Future studies or evaluations of the trail system could focus on identifying known conflict of use areas and recommending ways to encourage separation of use. High-use areas or conflict points include Tingley Park and the Gail Ryba Bridge. Increasing awareness of trail etiquette and communication would be handled as an education program, which is a currently ongoing program. For more information on current and new programs, see **Chapter 5, Recommended Programs**.

### **Equestrian Issues**

In the on-line survey conducted in 2010, approximately 10% of equestrian respondents reported riding Albuquerque’s trails. The majority of equestrian owners live in the Rio Grande Valley area although there are a few areas on the west side of Albuquerque where horses are still kept. The City and County have provided a few areas in the Valley with horse or equestrian parking available. A few notable examples include City Shining River Open Space Trailhead, Los Poblanos Fields Open Space, and the [Albuquerque/Bernalillo](#) County’s [Alameda](#) Bachechi Open Space. The City and County should continue to add equestrian facilities where appropriate to encourage more equestrians and support the horse culture New Mexico and the City.

## **B. Existing Facilities**

Albuquerque’s formalized bikeway and trail system consists of on-street facilities (bike routes, bicycle boulevards, bike lanes, wide lanes/paved shoulders) and off-street facilities (multi-use trails). A significant portion of the City’s bicycle facilities are trails, making up nearly one-half, or 277 miles, of the existing bicycle facilities in the area. Annually, the City prepares a map of the bikeways and trails in the metropolitan area for bicyclists and trail users.

**Figure 3: 2014 Bicycle Map** (Note: For illustrative purposes only. To view a full-size version of this map, please visit: <http://www.cabq.gov/parksandrecreation/recreation/bike>)



# 1. Types of Existing Facilities

## Bicycle Lanes

Designated exclusively for bicycle travel, bicycle lanes are separated from vehicle travel lanes with striping and include pavement stencils and signage. Bicycle lanes are most appropriate on arterial and collector streets in urban and rural areas where higher traffic volumes and speeds warrant greater separation than on local roads. There are approximately 203 miles of existing bike lanes within the city, most of which are located on collector and minor arterial streets. Most utilitarian bicyclists advocate for on-street facilities as the most functional facilities for bicycle transportation. These bicyclists have stated their preference for marked on-street bicycle lanes in numerous national surveys. Many bicyclists – particularly less experienced riders – are far more comfortable riding on a busy street if it has a striped and signed bike lane. Part of the intent of this Plan is to encourage new riders, and providing marked facilities such as bike lanes is one way of helping to persuade residents to give cycling a try. See **Figure 10: Existing Bikeways & Trails Map**, page 64.

If properly designed, bike lanes can [increase safety](#) [encourage more use](#) and promote proper riding. For this reason, bike lanes are highly desirable for [bicycle-utilitarian and recreational commutes and other](#)



~~utilitarian routes-uses~~ along major roadways. Bike lanes help to define the road space for bicyclists and motorists, reduce the chance that motorists will stray into the cyclists' path, discourage bicyclists from riding on the sidewalk, and remind motorists that cyclists have a right to the road. One key consideration in designing bike lanes in an urban setting is to ensure that bike lanes and adjacent parking lanes have sufficient width (usually a minimum of five feet for bicycle lanes) so that cyclists have enough room to avoid a suddenly opened vehicle door, see the Design [Guidelines Manual](#) for additional information.

## Bicycle Boulevards

Bicycle Boulevards are low-volume and low-speed streets where motorists and bicyclists share the same lane. A motorist will usually have to cross over into the adjacent travel lane to pass a bicyclist unless a wide outside lane or shoulder is provided. ~~Bicycle Boulevards are indicated with signage and pavement markings with a large image of a bicyclist~~Typically, such facilities are marked with special signage and pavement markings aimed at creating a ~~This is done to create~~ a unique identity for the Bicycle Boulevard. Bicycle Boulevards also typically have more intense design interventions, such as bulb-outs, chicanes, etc., that help ~~slow-calm~~ vehicular traffic.

~~A common treatment for Bicycle Boulevards is to set posted speed limits lower than 20 miles per hour~~Traffic calming and other treatments along the corridor may reduce vehicle speeds so that motorists and bicyclists generally travel at the same speed. This ~~creates a safer and~~ helps promote a safer and more comfortable environment for all users ~~and serves as a reminder to drivers that cyclists are prioritized on these facilities~~. Bicycle Boulevards ~~should~~ also incorporate treatments to help facilitate ~~safe more effective utilization and~~ safer, more effective utilization, and more convenient crossings where bicyclists must traverse major streets. Bicycle Boulevards work best in well-connected street grids where riders can follow reasonably direct and logical routes with few "twists and turns." Boulevards also work best when higher-order parallel streets exist to serve through vehicle traffic. There are approximately 6 miles of existing Bicycle Boulevards in Albuquerque. See **Figure 10: Existing Bikeways & Trails Map**, page 64.

## Bicycle Routes & Sharrows

The most common bikeways are shared roadways, which accommodate vehicles and bicycles in the same travel lane. They include link routes on local streets to get cyclists to designated facilities, as well as routes specifically designated as Bike Routes. The most suitable roadways for shared vehicle/bicycle use are those with posted speeds of 25-mph or less and low traffic volumes of 3,000 average daily traffic or less, many of which are in residential areas.



These facilities may include traffic-calming devices to reduce vehicle speeds while limiting conflicts between motorists and bicyclists. A common practice is to designate a system of shared roadways, which have bicycle route signs, directional arrows and other way-finding information. Bicycle routes may be marked with sharrows, which are pavement markings used to indicate a shared travel lane with both bicycle and motor vehicles.



Approximately 134 miles of bike routes currently exist throughout the city, providing convenient links to other parts of the bikeways system and to destinations throughout the city, including residential areas, transit stops, and schools. See **Figure 10: Existing Bikeways & Trails Map**, page 64.

### **Wide Lanes/Paved Shoulders**

A wide outside lane accommodates bicyclists on streets with insufficient width for bike lanes. Typically found in rural areas and on state highways, these facilities are on paved roadways with shoulders that are wide enough for bicycle travel (4'+). Shoulder bikeways often, but not always, include signage alerting motorists to expect bicycle travel along the roadway. See **Figure 10: Existing Bikeways & Trails Map**, page 64.

### **Bikeway Supporting Facilities**

The City has implemented a number of bikeway supporting facilities, including signage, bicycle detectors, bicycle parking and end-of-trip facilities. The Design Manual, Chapter 7, provides information about planning the location, design, and installation of these types of facilities.

### **Bikeway Signage**

Bikeway signage includes signs to identify a bike route, lane or multi-use trail to cyclists and drivers (e.g., “Bike Lane” signs posted along a roadway with a bike lane), signs that provide regulations or warnings to cyclists or drivers (e.g., “Bike X-ing” warning signs or bicycle-sized “Stop” signs), and signs that provide way-finding to cyclists (e.g., trailhead signage or bike route numbering). Examples of signs being used in Albuquerque are shown in **Figure 4** below.

In Albuquerque, most on-street facilities have standard bikeway signage, and some multi-use trail facilities have entrance monuments. There is currently little directional signage provided along bikeways in Albuquerque. Most local street connections, continuous bikeway routes, and destinations are not identified. Way-finding is difficult on trails that do not parallel roads, since cross streets and familiar landmarks are sometimes difficult to use as reference points. An important area of concern is the inability to readily identify a location on the multi-use trails for emergency response purposes.



**Figure 4: Signage Examples**



### ***Bicycle Detectors: Loops, Video Cameras, and Push-buttons***

Loop detectors are in-pavement wire sensors or video camera detection systems that activate traffic signals when a vehicle is positioned within or over the loop. The in-pavement wire sensor loops work by sensing the metal in the vehicle, and the video cameras detect changes in the background image. The in-pavement loop detectors and video camera detectors can be adjusted to be sensitive enough to detect when a bicycle has stopped over the loop, allowing a cyclist to activate a traffic signal. At some intersections that do not have dedicated right turn lanes, the City has installed pushbuttons, located at the stop bar next to the curb, allowing the cyclist to activate the pedestrian call.

### ***Bicycle Parking***

Short-term bicycle parking facilities consist of bicycle racks. These facilities are intended to accommodate bicycles of visitors, customers, messengers, and others for short periods of time. Racks are relatively low-cost devices that typically hold between two and eight bicycles, allowing bicyclists to securely lock their frames and wheels. Racks are secured to the ground and are located in highly visible areas.

Long-term bicycle parking facilities include lockers and other secure storage facilities that contain the entire bicycle. This type of parking is intended to accommodate bicycles of employees, students, residents, transit riders, and others expected to park more than two hours. This parking is provided in a secure, weather-protected manner and location. **Table 3** compares the typical characteristics of short- and long-term bicycle parking.

**Table 3: Characteristics of Short- and Long-Term Bicycle Parking**

Criteria	Short Term (Class B)	Long-Term (Class A)
Parking Duration	Less than two hours	More than two hours
Typical Feature Types	Bike racks	Lockers or racks provided in a secure area
Weather Protection	Unsheltered	Sheltered or enclosed
Security	High reliance on personal locking devices and passive surveillance (i.e., eyes on the street)	Restricted access and/or active surveillance/supervision. Examples: “Individual-secure” bike lockers, “Shared-secure” bike room or cage, Supervised valet bike parking, CCTV
Typical Land Uses	Commercial, retail, medical/healthcare, parks and recreation areas, community centers	Residential, workplace, transit, schools

**End-of-Trip Facilities**

Bicycle support facilities include end-of-trip facilities that would encourage bicyclists to commute to work or other activities by providing a way to “clean up” after a ride. Typically, these amenities include showers and clothing locker facilities located at places of employment. Such facilities are most often provided by building owners or tenants for use by employees.

**Trails (i.e., “Shared-Use Paths” and “Multi-Use Trails”)**

Trails provide off-street connectivity to community resources such as parks, open spaces, schools, libraries, community centers, employment centers, shopping centers, bus stops, and the soft surface trails within [Major Public Open Space areas](#). Shared Use Paths also provide commuting/transportation access to those who do not have the skill level or comfort level for on-street riding or just prefer to ride off-street.

Today, the City of Albuquerque has approximately 200 miles of paved, off-street, multi-use trails. These “trails” or “paths” provide recreational and commuter access throughout the City for pedestrians, equestrians, bicyclists, skaters, and other types of users. There has been a long history of planning and creating these trails with the recreationalist in mind, provide trail connections to more recreational facilities such as parks, Major Public Open Space, and the Petroglyph National Monument. A recent trend and current goal is to also plan trails with the commuter in mind. There are also over 100 miles of unpaved trails, [primarily located in Major Public Open Space areas](#).

The [Paseo del Bosque Trail](#), the Unser Boulevard Trail, the North Diversion Channel Trail, and the Tramway Trail are examples of some of the major north/south multi-use trails. These major north/south trails provide connections to the east/west trails such as Paseo del Norte, I-40 Trail, Paseo del Nordeste Recreational Trail, and Paseo de las Montañas Trail. Developers are starting to include multi-use trails as part of new subdivisions to accommodate bicycles for transportation and other forms of





recreational activity. The I-40 Trail connects the east and west sides of the city, crossing the Rio Grande River on a multi-use bicycle/pedestrian bridge. Albuquerque’s west side has fewer multi-use trails and is less well connected than the more mature multi-use trail system on the east side.

### Other Multi-Use Trails

The City has other multi-use trails that are not paved but also are intended for many various users. Unless these trails are located in Major Public Open Space or a City park, they are typically informal and not maintained as trails. An example of a formal unpaved trail is the recent project on the north side of the Hahn Arroyo, between Comanche and California, which provides a good example of how to separate users in high use areas. An example of an informal unpaved network is the extensive network of drains and ditches (also known as acequias) within the Middle Rio Grande Conservancy District (MRGCD), which owns and/or maintains this irrigation system.

Other non-paved multi-use trails can be found in City Major Public Open Space, County Open Space, the United States Forest Service, and the National Park Service among other public and private lands.

[According to a recent inventory, the Open Space Division manages just over 100 miles of official trails, including in City owned Major Public Open Space in Sandoval and Bernalillo Counties.](#) Many of these “single-track” trails are about one and a half to two feet wide and attract many hikers, runners, dog walkers, and mountain bicyclists. All of these paved and unpaved trails are considered to be part of Albuquerque’s multi-use trail system, despite the City’s varying degrees of oversight and maintenance on many of these informal trails.



### Regional / Long Distance Trails & Routes

The MRCOG Long Range Bikeway System Map designates regional trails as “Long Distance Facilities.” These bikeways and trails connect across the City or to other jurisdictions, such as Bernalillo County, Rio Rancho, Los Ranchos, and Corrales. The currently identified regional trails within Albuquerque include:

#### East/West:

- Paseo del Norte
- Osuna Rd. / Bear Canyon Arroyo
- Paseo del Nordeste
- Paseo de las Montanas
- I-40 Trail
- Rio Bravo Blvd.

#### North/South:

- Unser Blvd.
- Paseo del Bosque (River Trail) / Alameda west of the Rio Grande
- 2<sup>nd</sup> Street
- University Blvd.
- North Diversion Channel Trail

Much of the regional long distance trail and bikeway system has been constructed already; however, there are still significant gaps along these corridors. The City should focus on completing these gaps as

one of our main priorities. These links would be particularly suited for going after Federal or State transportation project funds because they connect across the Albuquerque Metropolitan Region.

The 50-Mile Activity Loop is another long-distance route being developed by the City. It consists of segments of trail, bikeways, and wide sidewalks. For more information about this project, see **Appendix B, 50-Mile Activity Loop Executive Summary**.

### Multi-Use Trail Crossings

The City's extensive multi-use trail system intersects streets, highways, arroyos, drainage channels, and the Rio Grande. Where these intersections occur, various crossing treatments are used to **provide safe and promote safer, more** convenient crossing opportunities for the trail user. These crossings can be divided into two basic groups: grade-separated and at-grade. Underpasses and overpasses are two subsets of grade-separated crossings. There are currently 31 grade-separated crossings; this Plan proposes 15 new grade-separated crossings, along with 87 at-grade intersections that are recommended for enhancements or redesign strategies.

#### Grade-Separated Crossings

These are crossings where the pedestrian or bicyclist is completely separated from vehicle traffic when crossing a street intersection, trail, arroyo, drainage, or other obstruction. Grade-separated crossings can be further divided into two categories: overpasses and underpasses.

Overpasses provide locations where the trails pass above the obstruction. The trail may require a dedicated structure to provide this separated crossing. The trail may be aligned with an existing roadway bridge where the path is provided space on the bridge. Shared roadway/multi-use trail bridges can be found



at some of the freeway, drainage channel, and river crossings. ~~There are areas throughout greater Albuquerque where it is crucial to put an overpass. Examples include Paseo del Norte and Coors and the east I 40 Trail at Rio Grande Blvd.~~ Overpasses can range from a simple pre-fabricated truss bridge, typically used to cross the shorter spans of arroyos and drainage channels like those along North Diversion Channel and Paseo del las Montañas, to the more complex bridge structure spanning multi-lane arterials and the Interstates, similar to the structures crossing Tramway, the newly constructed Bear Canyon Arroyo Bridge over Interstate 25, and several that cross Interstate 40.





An underpass serves a similar purpose as an overpass but differs in that the multi-use trail passes below the barrier. In locations where the multi-use trail is aligned with an existing roadway underpass, the multi-use trail can be provided space adjacent to the roadway for the crossing. Where trails run separate from the roadway, a modified culvert large enough to provide [safe protected](#) access for the trail user and maintenance equipment can be effective. The City has successfully used a technique termed “notches” where roadway bridges intersect multi-use trails following major drainage channel alignments. A notch in

the channel’s sloping side provides space for the multi-use trail to pass below the bridge.

### **At-Grade Crossings**

At-grade multi-use trail crossings of roadways may occur at controlled or uncontrolled intersections and mid-block locations. Where the multi-use trail is in close proximity to a signalized intersection, the trail alignment may be diverted to the intersection, as shown in the photo of the crossing at Matthew Ave. where the multi-use trail user crosses at the crosswalk. Another example is the La Presa Dam crossing at Interstate 40 and Unser Blvd. Two-lane to six-lane streets with multi-use trail mid-block crossings are located throughout the City’s bikeways network. Mid-block crossings are the most frequent



at-grade multi-use trail crossings ~~and a concern to planners, engineers, and users.~~ These crossings typically are not controlled with a traffic signal, so they present a major challenge to crossing at peak travel times. The implementation of specific design interventions must be considered on a location by location basis. The FHWA has endorsed and encourages a number of “Proven Safety Countermeasures” that include tools for mid-block crossings.

## **2. Existing Facility Enhancements – Current Issues**

### **Intersection and Crossing Improvements**

Intersections are challenging and dangerous for all travelers, particularly the more vulnerable bicyclist and pedestrian. Mid-block crossings where trails intersect major arterial streets are often difficult to navigate. On-street facilities in the developed portions of the city commonly “disappear” at the intersection, which typically adds turning lanes to increase the vehicular flow of traffic. This design

requires the cyclist to merge with vehicular traffic, which ~~can be safer and may help to~~ avoid a right-hook collision with turning vehicles. However, many cyclists and drivers do not know what to expect or do in these situations. Newer intersections with more right-of-way can accommodate a continuous bicycle lane or wide shoulder that is adjacent to the through lane; the right turn lane would cross the bicycle lane with this design. This plan discusses a variety of intersection treatments in the **Chapter 7.D, Design Manual**. Over time, the City should assess the existing intersections that include bicycle and pedestrian facilities and develop an approach to retrofit those intersections that are not consistent with the recommended designs.

### **Retrofitting Trails to be Universally Accessible**

The Americans with Disabilities Act of 1990 (ADA) prohibits discrimination and ensures equal opportunity for persons with disabilities in employment, State and local government services, public accommodations, commercial facilities, and transportation. The current text of the ADA includes changes made by the ADA Amendments Act of 2008 (P.L. 110-325), which became effective on January 1, 2009 and is now accompanied by the 2010 ADA Standards for Accessible Design. Together they provide national accessibility regulations for buildings and related urban environments. However, when designing outdoor recreational facilities or shared-use paths (locally referred to as trails or multi-use trails), the application of strict ADA standards often proves impractical. As of early 2014, there are no enforceable Federal ADA standards or a proposed ruling for shared-use paths. The Federal Access Board anticipates adopting final standards in July 2014.

The Federal Access Board has adopted is the Public Rights-of-Way Accessibility Guidelines (PROWAG), which perhaps come the closest to providing guidance for trails/paths. PROWAG does not directly affect trails currently, but a future ruling for paths will likely be very similar to these guidelines. Therefore, the City will attempt to use these guidelines where feasible when constructing new trails until the ruling on trails is adopted by the Federal Access Board.

The City's 1996 ADA Field Survey was focused on a sample survey of local roadways and sidewalks. This study estimated a cost of approximately \$63.6 million for correcting non-compliance with ADA for the major streets in the city, exclusive of legal fees and property acquisition. This report did not address the city's multi-use trails; however, the Parks & Recreation Department are currently evaluating both trails and parks for ADA compliance. For more information, see **Appendix C - ADA Field Survey**.

### **Bollard Placement Evaluation**

#### ***Bollard Placement and Spacing Evaluation on Multi-use Trails***

Bollards are a commonly used method of controlling vehicular access to multi-use trails. However, per the American Association of State Highway and Transportation Officials (AASHTO) *Guide for the Development of Bicycle Facilities, 2012* (Fourth Edition):

“The routine use of bollards and other similar barriers to restrict motor vehicle traffic is not recommended. Bollards should not be used unless there is a documented history of unauthorized intrusion by motor vehicles. Barriers such as bollards, fences, or other similar devices create permanent obstacles to path users.”

The goal of bollards should be to balance the need to discourage unauthorized motorized vehicle access on a trail with the need to provide the trail users a facility without unnecessary obstructions. AASHTO

has established several guidelines for the design of vertical barriers to make them as compatible as possible with the needs of path users and bicyclists.

In 2013, the City identified relevant design criteria for bollards on multi-use trail facilities, reviewed the installation of bollards on multi-use trails at selected locations, and then developed best practices for consideration of installed conditions and for future installations. This study was completed based on recommendations from GARTC and GABAC. These groups identified that the current bollard designs throughout the city are inconsistent and that excess bollards poses a hazard.

Therefore, Subsequently, the City of Albuquerque adopted a series of best practices for the installation of bollards on the trail system. This will provide consistency within the trail system and establish a level of expectancy with the trail users that will result in less confusion and improvements in accessibility for all types of users. For more information, see **Appendix C, Bollard Study**.

### **Multi-Use Trail Bollard Inventory**

The City developed an inventory of existing bollards on the City's multi-use trails system. Each bollard was photographed as a part of the inventory, and the photos was geo-tagged by a camera so that the data can be a part of the City's Geographic Information Systems (GIS) database. The inventory data collected will guide the city to retrofit and rehab locations that are inconsistent with the newly adopted best practices.

### **End-of-Trip Facilities & Programs**

End-of-trip facilities, including bicycle parking and other facilities such as showers and clothing lockers, can be a determining factor in whether someone decides to make a bicycle trip. They enhance the bicycling experience by providing cyclists with somewhere to park and somewhere to refresh themselves following their trip. Numerous studies have shown the value of these facilities in attracting cyclists to employment and activity centers and in supporting multi-modal trips. In fact, in the online survey conducted in 2010, nearly 70% of the people who responded indicated that more bicycle parking would likely influence them to bike and/or use the trail system more often.

The City does not currently have a bike rack installation program, which would be an excellent way to encourage utilitarian bicycle trips to retail and other destinations.

The City has no zoning requirement for end-of-trip facilities other than the bicycle parking requirements. Some businesses voluntarily provide end-of-trip facilities such as bike lockers, showers and changing rooms for employees who commute to work.

### **Recommended Locations for Additional Bicycle Parking Facilities**

The online survey, which had over 1,200 responses, contained two questions related to the location of additional bicycle parking facilities. The top responses to the question of which types of places should have more bike racks or lockers were grocery stores, shopping centers, work sites, restaurants, transit stops, and parks. Respondents provided specific locations for additional bicycle parking, including throughout the downtown and Nob Hill areas as well as along Central Avenue. The University of New Mexico Hospital received the highest number of responses. The most effective way for the City to increase parking at these and other locations would be through a Bicycle Rack Program. The City could kick off such a program by conducting outreach to businesses in the areas of town and to the types of businesses identified above.



## C. Bikeway & Trail System Analysis

The City completed an analysis of the existing bikeways and trail system and recommended future projects to extend and complete the network. This section analyzes the strengths and opportunities in the existing system, as well as the challenges and constraints that have often resulted in the gaps in the system that we have now. This system analysis forms the foundation for the recommended facilities that are presented in Part II of this *Facility Plan*, **Chapter 4, Recommended Network**.

### 1. Bikeway & Trail System - Assets & Challenges

#### Land Use and Destinations (“Demand” or Trip Generation)

The concept of “demand” for bicycle facilities can be difficult to comprehend. Unlike automobile use, where historical trip generation studies and traffic counts for different types of land uses permits an estimate of future “demand” for travel, bicycle trip generation methods are less advanced and standardized in the United States. Transportation planners use the concept of demand to analyze if existing facilities are sufficient and determine locations for new facilities. They also use the concept of “trip generation” to understand how much traffic a use may create, or the “trips generated.”

Land use patterns can help predict demand and are important to bikeway planning because changes in land use (and particularly employment areas) will affect average commute distance, which in turn affects the attractiveness of bicycling as a commute mode. The bikeways system will connect the neighborhoods where people live to the places they work, shop, recreate, or go to school.

As part of its Comprehensive Plan, Albuquerque has adopted a “Centers and Corridors” framework to guide development in the city. The goal is to expand and strengthen concentrations of moderate and high-density mixed land use and social/economic activities that reduce urban sprawl, auto travel needs, and service costs, and that enhance the identity of Albuquerque and its communities. The Comprehensive Plan designates Neighborhood, Community, Major, and Special Activity Centers. The Centers are connected by roads that are designated as Major and Enhanced Transit Corridors, which also provide enhanced non-vehicular access to the Centers. Express Corridors emphasize vehicular access throughout the city. Similarly, there should be enhanced bicycle facility connections to and within the Activity Centers.

As the City invests in new bikeways and trails, an emphasis should be placed on regional bikeway connections that serve the Major, Community, and Neighborhood Activity Centers in Albuquerque, which contain:

- Major employment centers
- Civic buildings such as libraries
- Transit stations
- Major retail and commercial centers
- Schools
- Parks and regional recreation areas

It is particularly important for the bikeway and multi-use trail system to provide access to destinations popular among pedestrians and bicyclists. Within Albuquerque, popular destinations include:

- Educational facilities including University of New Mexico, Central New Mexico Community College, and elementary, junior high, and high schools
- Employment centers including KAFB/Sandia Labs, Intel, Journal Center, and Mesa del Sol
- Commercial areas including those along Route 66/Nob Hill, Coronado and Cottonwood malls, ABQ Uptown, and neighborhood shopping centers and grocery stores
- Public facilities such as the Bio Park, Albuquerque Public Libraries, and museums
- Old Town, Downtown, and Uptown Albuquerque
- Rural roadways on the community's outskirts for recreational cyclists
- Nearby communities in the East Mountains and South Valley, Valencia County, and Sandoval County
- Natural areas within and outside Albuquerque, including City Open Space, Sandia Mountain foothills/Forest Service wilderness, National Monuments, and the Rio Grande Valley State Park.

By looking at the existing bicycle facility system map, one can see the extent of facilities across the city. The current development policy is to provide a bikeway every half mile, putting a bicyclist a maximum of a quarter-mile from a bicycle facility. This intent is generally achieved across the city; major exceptions include the south valley and mesa, the north valley, and the northwest mesa. In those listed areas, facilities are provided at closer to one mile intervals. Albuquerque is well-served in the northeast quadrant. The further west one travels, additional gaps in both the connectivity and accessibility of the bikeway system appear. See **Figure 5: Existing Bikeways & Trails Map**, page 39.

### Connections to Parks, Open Space, and Soft Surface Trails

Trails provide off-street connectivity to community resources such as parks, open spaces, schools, libraries, community centers, employment centers, shopping centers, bus stops, and soft-surface trails within [Major Public Open Space areas](#). Trails also provide commuting/transportation access to those bicyclists who do not have the skill level or comfort level for on-street riding or prefer to ride off-street.

The Parks, Open Space, and Trails (POST) concept is to provide connections that link neighborhoods to the trail system so the public can access parks, open spaces, [and Major Public Open Space area](#) and use trails to get around without reliance on automobiles. Ideally, each resident should have access to a trail within a 15-minutes' walk or bicycle ride. The trail system may include Federal, State, City and Private trails. Trails may be used for recreation and/or commuting. Trails with heavy commuter use shall be evaluated for expansion to separate non-commuters and commuters.

### Multi-Modal Connections

Multi-modal refers to the use of two or more modes of transportation in a single trip, (i.e., bicycling and riding the bus or train). This section describes bicycle-transit connections. Linking bicycles with Albuquerque's mass transit effectively increases the distance cyclists can travel, provides options in the event of a bicycle breakdown or collision, and gives cyclists alternatives to riding at night or in hot or inclement weather.

Making an effective multi-modal connection consists of several **key elements**:

- Providing **bicycle parking** facilities at transit stops and bike racks or storage on trains and buses
- Improving **bikeways that link with transit** facilities and stops, and

- Encouraging the use of bicycles on transit through education and encouragement programs.

### ***Bike & Ride the Bus***

ABQ Ride, the transit provider for the Albuquerque area, provides bike racks on all buses. When racks are full, bikes are allowed inside the bus at the driver's discretion. Transit centers in Albuquerque include: Alvarado Transit Center (1<sup>st</sup> St. & Central Ave.), Northwest Transit Center (Coors Bypass & Ellison Rd.), Central & Unser Transit Center, and the Uptown Transit Center (Uptown Blvd. & Americas Parkway).

### ***New Mexico Rail Runner Express***

Santa Fe is now connected to Belen by the Rail Runner Express commuter train. The Rail Runner currently has 14 stations, four of which are in Albuquerque. The Alvarado Transportation Center is its busiest station and is a multi-modal hub for rail and transit. Current bicycle use of the Rail Runner far exceeds the anticipated demand, creating some challenges in bicycle storage on the train and long-term storage at the stations. The bicycle-on-train counts provided by MRCOG for the year 2009 indicate a higher demand during the warmer months and may also be attributed to an increase in weekend train service.

### **Physical Constraints**

Identified below are major constraints that most bicyclists in and around Albuquerque encounter on their bicycle trips. **Figure 5: Opportunities and Constraints**, provides a graphical display of these constraints. ~~To provide~~ In order to help promote a direct, ~~safe~~ safe, and connected bikeway and multi-use trail network, the following constraints should be considered and resolved when possible:

- Rio Grande
- Expo New Mexico
- Private (Gated) Neighborhoods
- Drainage and Irrigation Alignments
- Major Public Open Space
- I-40 and I-25
- Airports
- Military Base
- West Mesa Escarpment
- Railroad Tracks
- Golf Courses
- Indian Pueblos
- Major Arterials

### ***Topography***

Albuquerque is located within the Rio Grande Rift. The valley's alignment is north/south, gently sloping up to the east toward the Sandia Mountains. The slope is slightly steeper on the west side where it encounters the west mesa escarpment. The elevations within the city range from approximately 4,950 feet along the Rio Grande to 6,100 feet in the Sandia foothills and 5,750 feet on the west mesa. Few rolling hills exist except for the crossing of the North Diversion Channel along the west mesa escarpment and in the Sandia foot hills. The broad central portion of the Rio Grande Rift, especially east of the river, has very little change in elevation and could be considered nearly level. The topography of Albuquerque is well-suited for cycling with gentle terrain and the occasional hill.

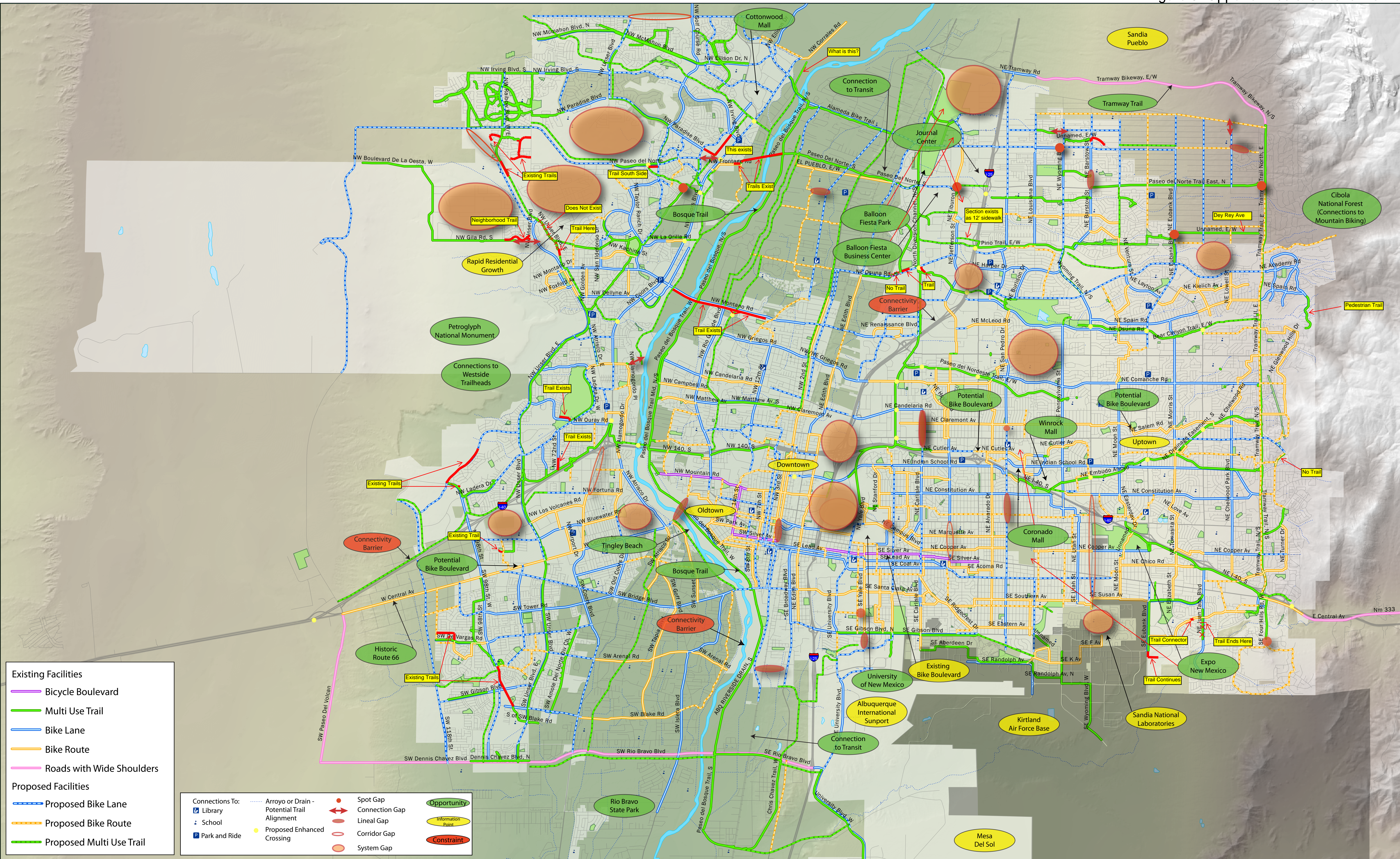
### ***Geography***

According to the United States Census Bureau, Albuquerque has a total area of 181.3 square miles. 180.6 square miles of it is land and 0.6 square miles of it (0.35%) is water. The city is bordered to the north by Sandia Pueblo and Rio Rancho, to the east by the Sandia Mountains and to the south by KAFB and Isleta

Pueblo, restricting the majority growth to the west side. The Rio Grande flows in a southerly direction through the central portion of the city dividing the west and east sides of the city.



Figure 5: Opportunities & Constraints



**Existing Facilities**

- Bicycle Boulevard
- Multi Use Trail
- Bike Lane
- Bike Route
- Roads with Wide Shoulders

**Proposed Facilities**

- Proposed Bike Lane
- Proposed Bike Route
- Proposed Multi Use Trail

**Connections To:**

- Library
- School
- Park and Ride

**Connections To:**

- Arroyo or Drain - Potential Trail Alignment
- Proposed Enhanced Crossing

**Connections To:**

- Spot Gap
- Connection Gap
- Lineal Gap
- Corridor Gap
- System Gap

**Opportunity**

- Opportunity
- Information Point
- Constraint



## **Other System Constraints**

### ***Bicycle / Vehicle Crash Locations***

Safety Avoiding collisions, fatalities, and serious injuries is a major concern for both existing and potential bicyclists. For those who ride, safety avoiding hazards safety is typically typically an on-going concern. For those who don't ride, it is one of the most compelling reasons not to ride. In discussing bicycle safety collisions and injuries, it is important to separate perceived dangers from actual safety hazards.

On-street bBicycle riding ~~on-street~~ is commonly perceived as unsafe an uncomfortable or potentially dangerous situation because of the exposure of a lightweight, two-wheeled vehicle to heavier and faster moving automobiles, trucks, and buses. Actual collision statistics, however, show that bicyclists face only a marginally higher risk of sustaining an injury than a motorist based on numbers of users and miles traveled. Death rates are essentially the same with bicyclists as with motorists. Bicycle-vehicle collisions are much less likely to happen than bicycle-bicycle, bicycle-pedestrian, or collisions caused by physical conditions.

Understanding what contributes to crashes can lead to facility and/or programming improvements, whether the cause is due to substandard design, sight distance, maintenance issues, user error, or lack of education. The health and well-being of facilities' users should be paramount.

### ***Lack of Way-finding Tools***

Albuquerque's bikeway and trail system could benefit from signage and other way-finding tools to orient users and direct them to and through major destinations like downtown, North Diversion Channel, the Paseo del Bosque Trail, as well as surrounding schools, parks, and commercial areas.

### ***Discontinuous Shared Use Path System***

Although the City of Albuquerque has made significant progress toward completing a comprehensive shared use path system, several major gaps remain. One notably discontinuous area includes access to the trails in the northwest and southwest parts of the city. Through these areas, non-motorized users must negotiate major roadways with high vehicle speeds and volumes. In some places, crossings are not provided, and in others marked crosswalks require path users to wait for long periods until cross-traffic has stopped to allow them to pass.

## **2. System Use**

### **Bikeway & Trail User Counts**

Non-motorized user counts were conducted on the Albuquerque area streets and trails to quantify utilization on both weekdays and weekends. These counts were collected at 37 weekday locations and 14 weekend locations between April 27, 2010 and May 22, 2010. Trail and bikeway user count data was collected at 45 weekday locations and 18 weekend sites; a number of locations counted both trails and on-street facilities. The weekday locations were collected for two hours during both the AM (7:00 to 9:00 am) and PM (4:00 to 6:00 pm) peak commute periods. The weekend data was gathered for three hours from 9:00 am to 12:00 pm, primarily along trails. There were 13 sites where both weekday and weekend data were gathered. See **Appendix D.1, User Count Data** for additional information.

The weekday counts were collected to quantify commuter cycling traffic within the Albuquerque area. That traffic uses both the on-street and trail systems, and a large number of count locations were selected

to determine what areas of the city experience commuter cyclists. Bicycle counts included both volumes and a number of additional characteristics, including if the rider was on the sidewalk, wearing a helmet, or if any traffic laws were violated by the cyclist. The bicyclist violations recorded were primarily traffic control violations. This research did not review data for cars or pedestrians.

The weekend counts were primarily collected to assess the number of recreational users of the trail system, thus the major non-motorized trail users were counted. Some on-street counts were gathered at strategic locations with on-street bike lanes or shoulders along common recreational routes, or at key locations with limited non-motorized facilities. The trail system counted each user that passed the specific location or intersection. The users were categorized as: bicyclists, runners/joggers, walkers, roller bladers/skateboarders, or equestrians.

### ***Bikeway & Trail User Count Results***

The highest weekend usage was along the Bosque Trail with an average of more than 200 users per hour per link at three locations. The Bosque Trail experiences the highest utilization in the Albuquerque area. Based upon observation, it is assumed that the majority of the Bosque Trail users were recreational users. Some cyclists during the weekday counts appeared to be commuters; however, the overwhelming majority appeared to be recreational. Cyclists were the most frequently counted trail users, who generally out-numbered the second most frequent, walking and jogging. The least common trail users were equestrians, and they were observed more frequently on weekdays than weekends.

Overall, the university area has the greatest amount of cycling traffic in the Albuquerque area and the highest weekday cycling usage occurred at the University of New Mexico (UNM). The University area also experiences the highest percentage of cyclists not wearing helmets and cyclists using the sidewalks, primarily along Central Ave. The Silver Ave-Buena Vista Dr. intersection experienced the highest number of traffic violations. This intersection is the only count site located on the existing Bicycle Boulevard, and has all-way stop traffic control. The high violation rate, 29.3 percent of all entering vehicles, is a concern.

Because most of the on-street locations were signalized intersections, the violations at these intersections were running red lights. Few cyclists were seen running a red signal indication without first stopping at the approach. The second most common violation was riding on the wrong side of the street in a bike lane. In 2014, the City prepared an education campaign to address this issue by providing billboards on ABQ Ride buses that were targeted at bicyclists, **Figure 6**.

**Figure 6: Educational Campaign Example**



A second concern was for the high violation and low helmet use at the Rainbow Blvd-Woodmont Ave intersection. The AM peak reflects middle school children traveling to school and it yielded a violation rate of 54% and helmet use of 23%. It appears that an educational program should focus on this area and age group.

The traffic violation data collected as part of the bikeway and trail user counts were used to inform programmatic recommendations targeted at education and enforcement. See **Chapter 5, Recommended Programs**.

#### **Volume Comparison: 1997 and 2010**

The Bosque Trail locations show a moderate increase in weekday activity and increases in helmet use. The Wyoming gate at KAFB shows a significant decrease in volume; however, additional detail from the previous plan indicates that much of the cycling traffic has shifted to the Eubank gates. The UNM area had significantly lower volumes during the AM peak period at each site counted, though the PM peak is slightly higher. The counts also indicate that helmet use has increased and violations are less frequent in the university area.

The Rio Grande Bosque trail locations show a moderate increase in weekday activity and increases in helmet use. The Wyoming gate at Kirtland Air Force Base (KAFB) shows a significant decrease in volume, however, additional detail from the previous plan indicates that much of the cycling traffic has shifted to the Eubank gates. The university area had significantly lower volumes during the morning peak period at each site counted, though the afternoon peak is slightly higher. The counts also indicate that helmet use has increased and violations are less frequent in the university area.

#### **Bicycle Commuting**

Data from the 1990 and 2000 US Census, shown in **Table 4**, indicate that bicycle use for commuting purposes has remained static for the last 20 years. This stable trend is reflected in the percent mode-share for all journey-to-work trips captured by the U.S. census data. This provides one measure of bicycle use, but does not include bicycle use for other trips (i.e., social trips, exercise trips, and other errands).

**Table 5** compares the Albuquerque's bicycle commute mode-share to the national average and several other cities in the western U.S. Approximately 0.9% of Albuquerque's population commutes by bicycle.

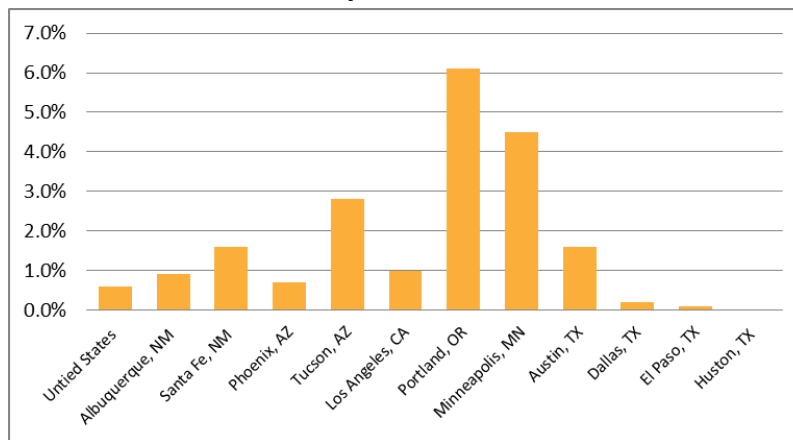
This is consistent with several other cities in the general vicinity, including Phoenix, AZ and Los Angeles, CA.

**Table 4: Bicycle Commute Data for Albuquerque over Time**

Journey To Work Mode Splits	1990	2000	2010	2012
Drive Alone	78.0%	77.7%	81.1%	79.5%
Carpool	12.1%	12.5%	8.7%	10.5%
Transit	2.0%	1.7%	2.0%	2.0%
Bicycle	1.2%	1.1%	1.4%	0.9%
Walk	2.9%	2.7%	2.6%	2.1%
Other	1.1%	0.7%	0.2%	1.2%
Work at Home	2.7%	3.6%	4.0%	3.9%

Source: U.S. Census & U.S. 2012 American Community Survey

**Table 5: 2012 Bicycle Commute Mode Share**



**Bicycle Commute Statistics:**

- About 65% of Albuquerque’s bicycle commuters are male. This is consistent with the male/female ratio reported in the online survey.
- The **average journey to work** trip for individuals traveling by taxi, motorcycle, bicycle, or other means was **about 23 minutes**, with the most frequent travel time being 10 – 20 minutes. This is consistent with a travel distance of two to three miles. This is slightly longer than the average 16 minute travel time reported in the 2000 Census data. The aggregated mode type could account for some of the variation in reported average travel times.
- About 20% of people who reported traveling to work via motorcycle, bicycle, taxi, or other means did not have a car or truck available for their use.
- The educational services, health care, and social assistance sector reported the highest number of people commuting via motorcycle, bicycle, taxi, or other means, which accounted for 24% of the tabulated response. A significant portion of this population is likely affiliated with UNM.

Current enrollment reported in 2013 at UNM is about 27,000. Estimated bicycle mode-share was not available for the University, but it is estimated the rates are about 10%, or about 2,500 bicycle commuters, which is consistent with rates reported by other universities across the U.S.

### 3. On-Street Bicycle Facility Needs Assessment

The Needs Assessment presents an overview of the needs of bicyclists and trail users in the Albuquerque area. This analysis provides an overview of cycling volumes and behaviors at many locations throughout the city; discusses public input gathered through an online user survey; and examines [cyclist safety—the potential for encountering hazards](#) by analyzing reported bicycle crash data. Three geographic analytical tools were used to determine the quality and connectedness of the existing system. Seven primary methods were used to evaluate the existing bikeways and trails facilities:

- **Bicycle Counts** were conducted at 38 locations throughout the City, which measured volumes of users as well as information regarding helmet use and traffic violations.
- The **Crash Analysis** provides a summary of crash data involving bicyclists in Albuquerque for the years from 1995 to 2005. Crash data can help identify difficult or dangerous areas for bicycles.
- A **Bicycle User Survey** was conducted between April and mid-June 2010, with over 1,200 individual responses to questions about preferred facility types, current transportation and travel behavior, and concerns about traffic [safety collisions and injury](#).
- The **Bikeway Quality Index (BQI)** creates a snapshot of current conditions of biking infrastructure using quality and quantity measurements.
- The **Cycle Zone Analysis (CZA)** allows the City to better understand what areas of the City would produce the most ‘bang for the buck’ when it comes to investing in bicycling and trails infrastructure.
- A **Gap Closure Analysis** was used to identify and evaluate specific locations where there are gaps in the system of either on-street bicycle facilities or multi-use trails. For descriptions of the proposed engineering solutions, see Chapter 4, Recommended Network.
- **StreetPlan** is a model that analyzes a number of roadway characteristics to identify corridors with the greatest potential to retrofit bike lanes into the existing street-section.
- The **End-of-Trip Facilities Analysis** reviewed the existing facilities, programs, and policies in order to make recommendations to improve the quality and knowledge of end-of-trip facilities.

This information was used in conjunction with field visits, input gathered at public meetings, stakeholder interviews, and analysis of the existing bikeways and multi-use trail system to form future project recommendations. Adequately identifying user needs enables system planners and policy-makers to develop cost-effective solutions for improving the region’s bikeway and trail system. The full description of these studies and their results is in **Appendix D, Compilation of 2010 Bikeways Data**.

#### Key Findings from the Analysis

- A disproportionate number of reported bicycle crashes, 83%, involve males who make up about 65% of Albuquerque’s reported bicycle population. This is consistent with findings from other U.S. cities.
- Albuquerque’s reported bicycle commute mode share has been static for about 20 years.



- A comparison of 1997 counts to 2010 counts found the highest morning peak on-street volumes at the Central Avenue and Yale Boulevard intersection. In 2010, 115 cyclists were counted here during the morning peak. This is a drop from the 164 cyclists observed at the same intersection in 1997. These drops in the morning counts are consistent with other count locations. This trend is not consistent with evening counts at the same locations where, in many cases, the numbers of cyclists increased slightly or remained the same. Potential reasons for these shifts could include a variation in the morning peak times or a shift in facility usage patterns.
- The highest on-street cyclist count volumes were found around UNM and KAFB. There was a significant shift of cycling traffic from the Wyoming gate to the new Eubank Gate. The greatest number of legal infractions (e.g., running a red light) were observed around UNM, while the greatest rates of compliance with roadway laws and helmet use were observed around KAFB.
- The highest weekday cycling use occurred at UNM. The highest weekend usage was along the Rio Grande Bosque Trail, with an average of more than 200 users per hour per link at three locations. The lowest weekday cycling usage occurred along Unser Boulevard; the lowest weekend usage occurred along Coors Boulevard north of Montañó Road.
- Trail counts indicated that there is significant off-street cycling activity for recreation and utilitarian purposes that is not captured in the census commute mode share.
- Streets with the greatest number of reported crashes and highest reported crash rates per mile were 4-6 lane roads without bicycle facilities. The roadways with the greatest number of crashes per mile included Central Avenue, east of the rail road, Lomas Boulevard and San Mateo Boulevard.
- The seven intersections with the greatest number of reported crashes were all located along Central Avenue. Count data was available at one intersection, Yale Boulevard, and indicated significant bicycle traffic during morning and evening peak hours.
- Nearly 2 out of 3 cyclists feel that bicycle lanes and multi-use trails do not connect to all the places they want to go.
- There is evidence that bicycle trips are replacing car commute trips when gasoline prices increase.
- Women responding to the survey generally identified as intermediate riders who prefer to ride on low traffic streets, while both genders indicated that bicycle routes and boulevards would 'very likely' increase their cycling. A greater percentage of women indicated strong support for this statement.
- Both men and women agreed that grocery stores were the land use most in need of increased bicycle parking. Other high-priority land uses included the work place, civic destinations (e.g., parks), shopping malls, and restaurants.

## Public Perspectives

From stakeholder interviews conducted by the project team and feedback collected from the open houses in May 2010, the following themes emerged relating to bicycle program needs and interests:

- To encourage bicycling on streets, **roads should feel safer**.
- The Albuquerque area has a **great trail system** that should continue to be promoted.

- Existing programs should be continued and expanded with the help of **more staff and resources**.
- There is the desire to get “interested but concerned” potential bicyclists riding.
- Strong support exists for driver and bicyclist education, Share the Road and Share the Trail campaigns and Summer Streets events. Open house participants also expressed support of Safe Routes to School programs, bicycling and trail counts, and enforcement programs.

**Chapter 5** describes existing education and outreach efforts around bicycling and trail use in Albuquerque and presents a menu of recommended new and expanded programs to continue to promote bicycle and trail use. **With limited local resources and funding, some of these programs may need to be developed and/or managed by private or non-profit groups.**

Additionally, the survey conducted by the project team resulted in the following considerations for development and prioritization of the bikeway and trail system:

- Focus high priority system improvements on closing small bikeway and trails gaps to high-activity destinations.
- Consider programs to increase bicycle parking at high priority locations across the city.
- Continue, and when possible, expand education, encouragement, and enforcement programs. Target these programs to key groups that are under-represented in the City’s current cycling demographic, including women and groups that would benefit from education such as school age children.

## 4. Current Studies & Programs

### Bicycle Boulevard Assessment

The City’s consultant has been tasked to review current City of Albuquerque and National design guidelines and practices for bicycle boulevard corridors relative to the existing bicycle boulevard that runs on Mountain Road, 14th Street, and Silver Avenue.

Bicycle boulevards are designed to be optimized corridors for bicycles that discourage motor-vehicle cut-through traffic but otherwise allow local vehicular traffic. Study data is collected on signing and striping installations specific to the bicycle boulevard, traffic control at all intersections along the boulevard, bicycle related traffic control at arterial crossings, traffic calming elements to determination of conflict points.

Consultant tasks include research of the City of Albuquerque Bike Plan and national literature to identify criteria pertaining to the implementation and design of bicycle boulevards. The research will include, but not be limited to, the design application, implementation criteria, motorized vehicle volumes, and corridor operations. A technical memorandum summarizing the findings of the bicycle boulevard research and the evaluation of the bicycle boulevards in Albuquerque will be developed by the consultant. The critical design elements of the existing boulevard findings will be summarized in tabular format and design features will be identified using available aerial photography. Based upon deficiencies identified in the existing bike boulevard installation and criteria collected from other national bicycle boulevards, recommendations are to be provided so that best practices can be applied during the design and implementation of future City of Albuquerque bike boulevard projects. Once we know what they are we will address them and use this on future projects.

## Bicycle Route Signage Inventory and Assessment

This project is to provide information to the City so that signage for existing routes can be updated in accordance with the *2009 Manual on Uniform Traffic Control Devices (MUTCD)* and the *2012 Guide for the Development of Bicycle Facilities* (or the “Bike Guide”). The consultant prepared a geographic information system (GIS) database, which registers the various signs identified by code and location. This information can then be used to budget phases and be provided to in-house staff or on-call contractors in order to install the various signs.

Bike routes represent the third tier of bikeway facilities serving bicyclists, below multi-use paths and bike lanes. For the purpose of this report a bike route is a street or roadway that has been identified by City personnel as a bike route. Unlike multi-use paths or bike lines, bike routes without proper signing may be indistinguishable from other roadways, which have not been identified as routes. As such, a growing need to provide proper signage had been identified to City staff.

With the increased use by cyclists the design team felt that it was prudent to follow the guidance of the *MUTCD* and *Bike Guide* to also post the bicycle warning sign (W11-1) supplemented with the “SHARE THE ROAD” plaque (W16-1P). This combination of signs is intended to provide motorists with an indication that there may be bicyclists in the roadway, along their direction of travel and that “they should be mindful and respectful of bicyclists” (*Bike Guide*). Additional posting of the W11-1 (without the W16-1P) were placed on the approaches of roadways that intersected routes, but were uncontrolled (i.e. no traffic control device such as a stop sign or signal used).

FIGURE 7: BICYCLE ROUTE SIGNAGE



The draft study recommendation is to add a significant number of new postings to the City’s database. Approximately 2,500 new sign locations were identified, which would receive close to 4,600 new signs (some sign posts would have multiple signs). The study provided a cost estimate of over half a million dollars for the new signage, which will be addressed as future implementation projects as budget allows. Installation of the recommended signage will officially designate many of the bike routes that are identified as proposed in this Plan.

## Bicycle Corridor & Way-finding Sign Development Project

The project scope consists of developing a Bicycle Route Way-finding Signage and Corridor Development Plan within the City of Albuquerque and Bernalillo County.

The City’s consultant will review the existing *Bikeways and Trails Master Plan*, the *50-Mile Activity Loop Master Plan*, and MRCOG’s *2035 Long Range Bikeway Systems Map* in order to develop a baseline for the

project. In coordination with City staff the consultant will review the city maps to identify bicycle destination sites (i.e., North Diversion Channel Trail, Bosque Trail, University of New Mexico, Central New Mexico Community College, Balloon Fiesta Park, Zoo and Bio Park, city hospitals, regional employment centers, etc.) and bicycle corridors used to assess community-wide destinations.

Once a prioritized list of destination sites and corridors has been developed, the consultant will develop way-finding signs for the destinations and corridor links. All way-finding signs will be developed in accordance with the 2009 Version of the MUTCD using GuideSign CADD software.

After obtaining final input on the destination sites, recommended bicycle corridors, way-finding sign development, and corridor placement from the staff and the public, the consultant will provide a summary report that outlines methodology, processes, and procedures used in the overall development of this project as well as associated costs to install these signs throughout the City. In addition to the summary report, the consultant will also submit to the City a geographic database of proposed new way-finding sign locations.

## **5. Bikeway & Trail System – Current Issues**

### **Coordination between City Departments & Other Agencies**

The City bikeway and trail system links to the Bernalillo County bikeway and trail system and utilizes AMAFCA and MRGCD facilities. Input from and coordination with these entities outside the City governmental structure is required for effective planning, operations, and maintenance of the system.

Within the City, the Department of Municipal Development (DMD) develops and manages the on-street facilities, and the Parks & Recreation Department (P&R) designs and manages the trails. DMD typically manages the construction phases of both facilities. There is coordination between the two departments primarily during the implementation phases. The development of a single system of bikeways and trails requires close coordination among all relevant City Departments throughout the planning, prioritization, design, and development stages of facility construction, as well as programming and maintenance.

### **Advisory Groups**

Albuquerque has two advisory committees related to bicycle and trails issues. Both are created by ordinance: the Greater Albuquerque Bicycling Advisory Committee (GABAC) by §14-13-3-6 and the Greater Albuquerque Recreational Trails Committee (GARTC) by §14-13-3-8. The two-committees provide multiple perspectives regarding the bikeways and trail system. It requires both Departments (P&R and DMD) that are critical to development/maintenance of the paved trail network to engage in the issues raised by the advisory committees. The paved trails are used by both constituencies.

There are a number of challenges that result from Albuquerque's two-committee structure, such as many of the guest presentations must be duplicated for each group and the need to fill a large number of volunteer positions. Another challenge is that staffing advisory groups has been estimated in other communities as taking approximately 35% of the bicycle/pedestrian staff's time. With two advisory groups, more staff time and resources are devoted to staffing the advisory groups, which leaves fewer resources to implement projects. These groups officially have non-voting members, such as NMDOT and Bernalillo County; however, those other agencies have become less involved over time in the ongoing operations. [The NMDOT continues to encourage multi-modal improvements within state facilities.](#) There are overlapping responsibilities between the groups, which each have different forms of representation.





The groups have not had ongoing training about the purpose and role of the committees. Currently, the groups primarily review projects as they are being developed, instead of serving a planning or policy-related function, as many other citizens advisory groups do. It is unclear at which stage the advisory groups could have the most impact on the implementation of the *Bikeways & Trails Facility Plan*.

### Way-finding & Orientation

Albuquerque's bikeway and multi-use trail network could benefit from signage and other way-finding tools to orient users and direct them to and through major destinations. Way-finding is difficult on trails that do not parallel roads, since cross streets and familiar landmarks are sometimes difficult to use as reference points. An important area of concern is the inability to readily identify a location on the multi-use trails for emergency response purposes. These issues are addressed through recommended facility improvements, see **Chapter 7, Design Manual**, and page [485758](#), Bicycle Corridor and Way-finding Sign Project, as well as through a future program to name and sign trail locations.

### Discontinuous Network (Gaps)

A number of national and local surveys cite that safe, well-maintained bicycle facilities act as incentives to increase daily bicycle trips. Similar research exists for people who choose walking or other forms of pedestrianism. To support this assertion, the survey conducted as part of the planning effort in 2010 found that the two most important factors to make bicycling more attractive are: 1) providing additional bicycle and trail facilities, and 2) improved maintenance.

Although the City has made significant progress toward completing a comprehensive bikeways and multi-use trail network, several major gaps remain. One notably discontinuous area includes access to the trails in the northwest region of the city. The Paseo del Norte multi-use trail connection at Coors Boulevard and through or around the Paseo del Norte interchange should be improved with a grade-separated crossing, connecting to trails west of Coors Boulevard. Multi-use trails along Unser Boulevard and 98th Street, south of I-40, should be linked together by additional bikeways and trails in the east/west direction. The trails in Paradise Hills and Taylor Ranch also lack sufficient north/south connections. This plan proposes new bikeways and trails in these locations and others across the city where connectivity needs to be enhanced.

### Trail Counts

Multi-use trails are popular with both commuters and people recreating. Basic trail counts have been done, but nothing to date has been completed that can substantially tell transportation and trail planners who is doing what or going where. Gathering this type of data over a long period of time can be very beneficial for planners to predict and project where the trail network may need to grow or change.



Recently, the MRCOG, Bernalillo County, and the City of Albuquerque have begun to install or have installed permanent trail counters throughout the greater Albuquerque paved multi-use trail network. Bernalillo County funded seven permanent counters at specific key intersections or high-use locations. These include cameras to count pedestrians and loop sensors to count cyclists. Analyzing the data will help Planners project future trail needs. Two infrared sensors and loop sensors were installed in 2014 in collaboration among MRCOG, Parks & Recreation, and the Rails to Trails Conservancy.

Even with counters, it is impossible to know exactly if someone is commuting or recreating unless interviewed, but it can be assumed during certain times of the day and whether it is a weekday or weekend what people may be doing. The most important aspect is to get a big picture of areas that are in high demand and where new trail segments or gaps are needed most. It is also important to connect existing trails to new areas of growth to ensure that everyone has the option to use the trail system whether it beis for commuting or exercise. The 2010 trail and bikeway count data are provided in **Appendix F, User Count Data.**

### **Maintenance**

Timely and consistent maintenance of the multi-use trail system is important to help improve safety and to make the trails safe and more enjoyable for trail enthusiasts. In recent years, budget constraints have hampered the City's ability to regularly maintain the trail system. Responsible agencies have come to depend on user notification or complaints, such as by using the City's 311 system, to notify them of segments or facilities in need of maintenance. It is challenging in Albuquerque, given budget constraints, to adequately maintain the trails system. In recent years, the maintenance has become 311-driven. Park Maintenance is trying to move toward a more systematic, proactive approach. They are exploring maintenance pilot projects, as described in Section 6.C.1, as well as moving towards an electronic tracking system called YARDI.

One notable challenge has been the spread of adjacent gravel, thorny seeds and other debris on to paved trails by users, weather or vehicles. Given that most of the trail network is un-landscaped and the vegetation is subject to the availability of natural precipitation, the challenges are different than for other park facilities. Among other maintenance policies, this plan suggests the City move towards establishment of native grasses along the trails: to combat noxious weeds, reduce maintenance requirements, and make the trails more pleasant for the trail users.



---

# PART II: RECOMMENDATIONS

---

The next several chapters describe the recommended bikeway and trail network, including priority bicycle facilities projects that are likely feasible and most capable of providing the greatest community benefit and improvements (**Chapter 4**), recommended outreach and education programs (**Chapter 5**), implementation strategies (**Chapter 6**), and the Design Manual (**Chapter 7**).

## **CHAPTER 4: RECOMMENDED NETWORK**

The previous chapter reviewed the cyclist, pedestrian, and trail enthusiast needs, existing system components and needs, and current issues. This information was used in conjunction with field visits, input gathered at public meetings, stakeholder interviews, and analysis of the existing bikeways and multi-use trail system to provide future project recommendations. Comments that were received throughout the planning process were catalogued to ensure that they were all considered in the development of this plan. Some comments expressed conflicting desires or recommendations with other responses; other comments are not immediately feasible to include or recommend due to budget, staffing, or resource availability. When public comments and ideas were not possible to achieve in the near-term, they were included as a recommendation for future consideration.

### **A. Facility Gap Analysis**

As a city-wide plan, the *Bikeways & Trails Facility Plan* reflects previous planning efforts while focusing on providing a connected on-road bike network and multi-use trail network within Albuquerque. The existing bicycle facilities discussed in this plan were developed from the Albuquerque Bikeways GIS layer, while proposed facilities were found in the MRCOG Long Range Bikeway System Map, the *Trails & Bikeways Facility Plan*, 1993, and adopted plans.

One purpose of the planning process is to refine, augment, and prioritize the proposed facility recommendations contained in the MRCOG Long Range Bikeway System Map. The final recommendations are based on facilities recommended in previous planning efforts, needs analysis and level of service provided by existing facilities, input from stakeholders, fieldwork, community comment, and input from other relevant municipal staff and decision makers.

#### **1. Existing Bikeway & Trail Evaluation**

##### **Bikeway System Evaluation Approach**

This section provides an approach to analyzing the quality of existing on-street bicycle routes in Albuquerque. While it is a priority to add new facilities to complete the bicycle network in Albuquerque, it is also important to ensure that the existing facilities are usable. The tables that follow document the approach to evaluating the quality of existing routes. Most facilities in Albuquerque are deemed adequate, though many could use minor improvements, such as more frequent stenciling in the bike lane. Another frequently identified **problem-challenge** is the need to **identify-address narrow** bike lanes that do not meet the current width standards. The City should strive to identify the extent of bicycle lanes that are deficient in marked width, according to the current DPM standards and highlight these

~~locations of deficient on the printed Bike Map.~~ When prioritizing new projects, the City should target existing bicycle facilities that may be out of compliance with DPM and/or Design Manual criteria, when feasible and provided sufficient right-of-way exists or can be reasonably obtained. Additionally, a future study of the City’s on-street bicycle facilities should be completed according to the evaluation criteria identified below. This action is listed as a short-term priority action in the Implementation Plan.

**Table 6: Infrastructure Project Evaluation Criteria**

Criterion	Measurement
<a href="#">Safety Collisions &amp; Injury</a>	Can the project potentially improve bicycling and walking at locations with perceived or documented <a href="#">safety issues/collision or injury potential</a> ? This criterion takes into account available crash data as well as feedback from the Steering Committee and Albuquerque residents.
System Connectivity	To what degree does the project connect to other bikeways or walkways, shared use paths, and transit routes?
Completeness of Network	Are gaps present along the facility? Gaps are described in more detail following.
Barriers and Constraints	Do barriers prevent free movement along the route? Barriers may include major streets, rivers, steep hills, railroad tracks, and unconnected streets.
Serve Non-Motorized Needs	Does the route serve the needs of different types of bicyclists, pedestrians and other non-motorized users?

## 2. System Gap Analysis

This section discusses the identification of gaps within the existing City of Albuquerque bikeway and trail networks. The text first defines common bikeway and trail gap types with respect to streets and trails. Various gap closure measures used throughout the United States and other countries are discussed, including both on- and off-street treatments that could be applied in Albuquerque. The text concludes with a procedure for identifying and correcting Albuquerque’s bikeway and multi-use trail network gaps.

This approach was used to inform the bikeway and trail recommendations made in this Plan. **This approach should also be used to analyze newly developing parts of town, gaps created between adjacent jurisdictions, and opportunities for future facilities as they arise.**

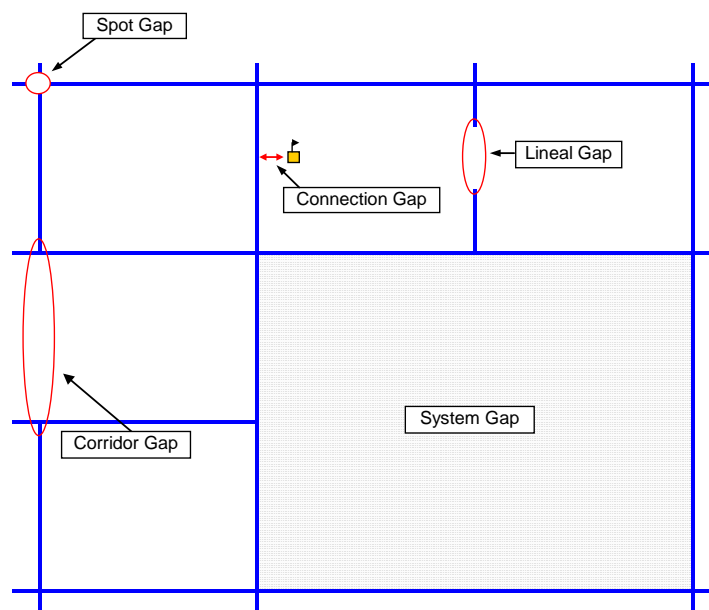
### Defining Bikeway and Trail Gaps

Bikeway and trail gaps exist in various forms, ranging from short “missing links” on a specific street or multi-use trail corridor, to larger geographic areas with few or no facilities at all. Determining specifically what constitutes a “gap” ~~requires would benefit from~~ [may be accomplished by](#) setting parameters for the bikeway and trail networks and determining which activity centers and major destinations require direct links to the networks. Gaps can then be organized based on length and other characteristics. Gaps can be classified into five main categories:

- **Spot gaps:** Spot gaps refer to point-specific locations lacking dedicated facilities or other treatments to ~~accommodate safe and~~ [help promote safe and](#) comfortable pedestrian or bicycle travel. Spot gaps primarily include intersections and other areas with potential conflicts with motor vehicles. Examples include bike lanes on a major street “dropping” to make way for right turn lanes at intersection, or a lack of intersection crossing treatments for pedestrians on a route or sidewalk as they approach a major street.

- **Connection gaps:** Connection gaps are missing segments (¼ mile long or less) on a clearly defined and otherwise well-connected walkway or bikeway. Major barriers standing between destinations and clearly defined routes also represent connection gaps. Examples include bike lanes on a major street “dropping” for several blocks to make way for on-street parking; a discontinuous sidewalk along a street; or a freeway standing between a major pedestrian or bicycle route and a school.
- **Lineal gaps:** Similar to connection gaps, lineal gaps are ½- to one-mile long missing link segments on a clearly defined and otherwise well-connected walkway or bikeway.
- **Corridor gaps:** On clearly defined and otherwise well-connected bikeways, corridor gaps are missing links longer than one mile. These gaps will sometimes encompass an entire street corridor where bicycle facilities are desired but do not currently exist (does not apply for walkway gaps).
- **System gaps:** Larger geographic areas (e.g., a neighborhood or business district) where few or no bikeways exist would be identified as system gaps. System gaps exist in areas where a minimum of two intersecting bikeways would be required to achieve the target network density (does not apply for walkway gaps).

**Figure 8: Diagram of Gap Types**



Gaps typically exist where physical or other constraints impede walkway or bikeway network development. Typical constraints include narrow bridges on existing roadways, severe cross-slopes, and potential environmental damage associated with wider pavement widths. Traffic mobility standards, economic development strategies, and other policy decisions may also lead to gaps in a network. For instance, the City’s desire for on-street parking or increased vehicle capacity may hinder efforts to install continuous bike lanes along a major street. **Figure 8** presents a theoretical diagram illustrating the five gap types described above.



### 3. Gap Closure Measures

Numerous approaches exist for addressing bikeway system gaps. The following sections discuss various gap closure measures, ranging from minor treatments (e.g., signage) to larger-scale applications (e.g., new trail corridors).

#### Intersection Improvement Measures

Intersection improvements concentrate on facilitating ~~safe~~effective, convenient, and comfortable bicycle travel through intersections where minimal or no bicycle facilities exist. While the measures are largely intended for bikeways on major streets, some treatments may be appropriate on bikeways using secondary street corridors, and at multi-use trail/roadway crossings. Although the intersection improvement measures are most appropriate for addressing spot gaps, they could supplement other measures as part of larger efforts to address lineal, segment, corridor and system gaps.

Treatments for **improving intersections** for bicyclists include:

- Colored bike lanes – [“Innovative Treatment” – see Design Manual](#)
- Shared bicycle/right-turn lanes
- Shared bicycle/double right-turn lanes
- Bike boxes – [“Innovative Treatment” – see Design Manual](#)

#### Interchange Areas

Arterial streets may include free-flowing interchanges with high-speed merge lanes at freeway entrance and exit ramps. These conditions create a challenging bicycle environment for several reasons:

##### Challenges for bicyclists:

- Merging (especially exiting) motorists do not expect to see cyclists.
- Motorists cross the bicyclist’s path travelling at high speeds as they transition to/from ramps.
- The angle and position of the merging ramp creates visibility challenges, forcing bicyclists to monitor overtaking traffic by looking over their left and right shoulders.
- Exiting vehicles may not signal their intent to cross the bicyclist’s path.
- The design of merge/diverge points typically includes long vehicle/bicyclist conflict zones.
- [The legal right-of-way is unclear in some interchanges where there is a free-flowing, dedicated lane instead of a merging lane that would intersect with the bicycle lane.](#)

Albuquerque should consider solutions to these issues that have been implemented successfully in other major metropolitan areas. The City of Portland, Oregon has addressed this issue with striping or physical elements that encourage bicyclists to cross ramps at or close to a right angle. The treatment shortens the vehicle/bicycle conflict zone while also improving sight distance for bicyclists. Some bicyclists may choose to ignore this treatment, however, as this creates a less-direct route through the interchange area and forces them to relinquish right-of-way to exiting motorists.

Interchange area treatments include both signal timing and scrambler signal treatments.

#### Arterial Bike Lane Retrofit Measures

~~Most~~ Many arterial streets in Albuquerque exhibit characteristics (e.g., high vehicle speeds and/or volumes) where dedicated bicycle lanes may better accommodate ~~safe~~effectivesafer and more

comfortable riding. Indicating a preferential or exclusive space for bicycle travel, bike lanes are typically five to six feet wide delineated by striping and pavement stencils. These facilities create a predictable environment for motorists and bicyclists by clarifying the appropriate position for each user on a roadway. Bike lanes on congested streets also enable cyclists to pass slow or stopped vehicles on the right.

The measures listed below represent various approaches for adding bike lanes to existing streets. Although opportunities to add bike lanes through roadway widening may exist in some locations, most major Albuquerque streets pose physical and other constraints requiring street retrofit measures within existing curb-to-curb widths. As a result, the measures effectively reallocate existing street width through striping modifications to accommodate dedicated bike lanes.

The bike lane retrofit measures listed following are most appropriate for addressing connection gaps and lineal gaps, though they could supplement other measures to address corridor and system gaps. Although largely intended for arterial streets, these measures may be appropriate on collector streets where bike lanes would best accommodate cyclists.

#### **Treatments for retrofitting arterial streets with bike lanes include:**

##### • [Shoulder widening](#)

- Reducing travel lane or on-street parking lane widths
- Removing travel lanes (road diet)
- Removing on-street parking
- Floating or off-peak bike lanes
- Uphill bike lanes
- Left side bike lanes on one-way streets
- Contra-flow bike lanes on one-way streets

##### • [Cycle tracks](#)

- [Shoulder widening on temporary road sections without curb and gutter](#)

#### ***Arterial Shared Roadway Measures***

~~Although most arterial streets in Albuquerque have sufficient traffic volumes to warrant dedicated bike lanes, physical constraints or other factors may preclude these facilities. Because arterial streets typically provide the most direct routes to major bicyclist destinations and also serve as destinations in and of themselves, bicycle facility provisions on these corridors still hold great importance.~~

~~The measures below represent various approaches for accommodating bicyclists on major streets where bike lanes are desired but not possible. Similar to the bike lane retrofit measures described earlier, the arterial shared roadway measures work within existing curb-to-curb widths and do not impact vehicle or on-street parking capacity. The measures include various signage and pavement marking treatments to inform motorists of bicyclists on the roadway and to inform all users of appropriate behaviors.~~

~~The arterial shared roadway measures described below are most appropriate for addressing connection gaps and lineal gaps, though they could supplement other measures to address corridor and system gaps. Although largely intended for arterial streets, these measures may be appropriate on collector streets.~~

### Treatments appropriate for shared roadways include:

- ~~Wide curb lanes~~
- ~~Shared lane markings~~
- ~~Combined bicycle/bus lanes~~
- ~~Warning signage on shared roadways~~
- ~~“Share the Road”/“Watch for Bicyclists” Signage~~
- ~~“Bicyclists Allowed Use of Full Lane” Signage~~
- ~~“Bike Lane Merges” Signage~~

### Alternative Routing Measures

Alternative routing on secondary streets may be necessary to address bikeway connectivity needs where constraints preclude bike lanes or other treatments on arterial roadways. Alternative routing may also be necessary where constraints preclude a continuous multi-use trail corridor. Although these measures can effectively fill on- and off-street bikeway gaps, they should be applied only after careful consideration of several factors, discussed below.

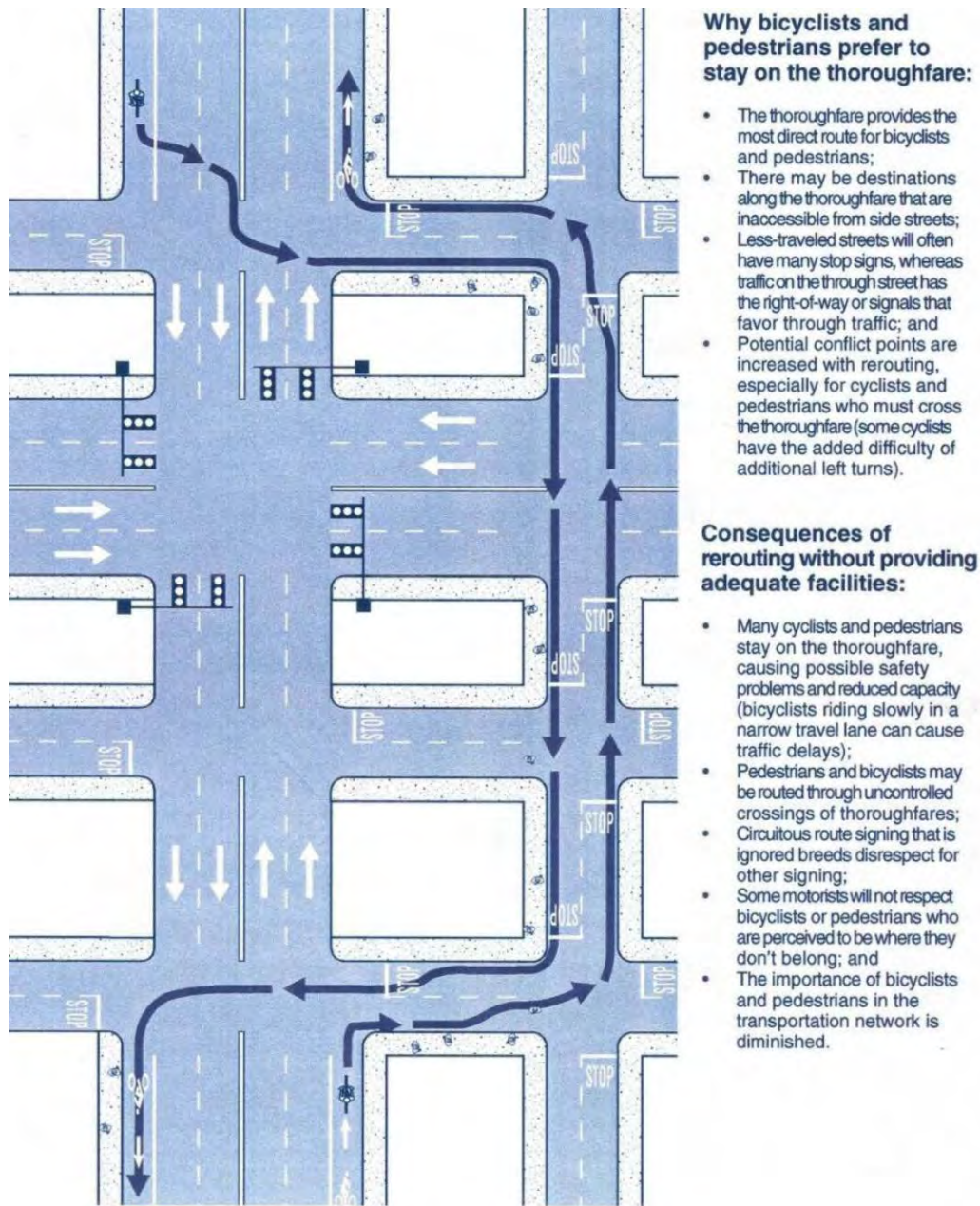
Bicyclists often gravitate to arterial and other major streets for several reasons:

- Major streets generally offer the most direct routes between bicyclist destinations while providing better connectivity compared with lower-order streets.
- Major streets usually have the right-of-way or signals favoring through traffic, whereas secondary streets often have numerous stop signs which can slow bicycle travel.
- Major streets include provisions to overcome major barriers such as railroads, freeways and drainage channels.
- The commercial character of major streets (e.g., employment, shopping, etc.) makes these corridors destinations in and of themselves.

Illustrated in **Figure 9**, alternative routing measures pose several challenges:

- Bicyclists on major streets may ignore alternative routes if they are used to overcome spot gaps and connection gaps. The relatively short lengths of spot and connection gaps may induce riders to remain on the thoroughfare despite the lack of bicycle accommodations, potentially ~~creating safety issues~~ cyclist hazard subjecting themselves to increased hazard.
- Bicyclists may not be aware of the alternate route. When developing alternate route options, some of the cyclist route tracking applications should be consulted to understand current routing preferences.
- Bicyclists may perceive the alternative route as too circuitous.
- The alternative route may include uncontrolled crossings of major streets.

**Figure 9: Alternate Routing Issues (Source: Oregon Bicycle & Pedestrian Plan)**



It should be noted that alternative or parallel routing measures on secondary streets offer some benefits. Some users may not feel comfortable riding on major streets for various reasons (e.g., high traffic volumes and vehicle speeds, conflicts with motorists entering and leaving driveways, and/or conflicts with buses occupying bike lanes while loading and unloading passengers). Children and less-experienced riders might find these environments especially challenging. Secondary streets provide alternate route choices for bicyclists uncomfortable using the major street network.

Albuquerque benefits from a generally well-connected system of collector and local streets in many neighborhoods that – with the addition of relatively small-scale treatments – could be used to overcome bikeway system gaps. These streets (referred to as Bike Routes or Signed Shared Roadways) accommodate bicyclists and motorists in the same travel lanes often with no specific vehicle or bike lane



delineation. These corridors include warning signage to alert motorists of bicyclists on the roadway and may include way-finding signage to orient cyclists on the route. Alternative routing measures are largely intended to address lineal, corridor, and system gaps and are less appropriate for addressing spot and connection gaps (spot and connection gaps should be directly addressed on the corridor in which they are located). The measures fit within the overall concept of “Bicycle Boulevards,” which incorporate a variety of treatments to enhance bicycle travel on these lower-order streets.

### Trail Gap Closure Measures

The measures below largely focus on completing multi-use trail/bikeway gaps (e.g., discontinuous multi-use trail segments) and are most appropriate for addressing connection, lineal, corridor, and system gaps on the trail network. It should be noted, however, that some measures could effectively address some trail or bikeway gaps, especially connection gaps near on-street bikeways (e.g., a bicycle/pedestrian bridge crossing a freeway to connect an on-street bikeway with a nearby school).

Off-street gap closure methods can include:

- **Drainage easements** utilize maintenance easements to complete multi-use trail system gaps. Drainage corridors offer several advantages, including relatively direct routes between major destinations, and following gently sloping terrain. A license agreement with AMAFCA is required for trails in drainage easements.
- **Utility and irrigation corridor trails** typically include power line and water utility easements, as well as canals and drainage ditches. These corridors offer excellent transportation and recreation opportunities for cyclists and trail enthusiasts of all ages and skills. [Some safety issues due to The proximity to the irrigation ditches or power poles and transmission lines should be understood and appropriate protective fencing/railing and warning signs installed and/or other safety measures as identified by the utility.](#) A license agreement with [PNM or MRGCD, respectively,](#) is required for trails in [utility and irrigation corridors and an encroachment agreement is required for trails in electric utility corridors. In addition, a landowner agreement with the underlying property owner may be required.](#)
- **Trail over-crossings and under-crossings** provide critical multi-use trail system links by joining areas separated by any number of barriers. Over-crossings and under-crossings [can help](#) address real or perceived [safety security safety](#) issues by providing users a formalized means for traversing “problem areas” drainage channels, waterways or major transportation corridors.
- **Access-ways** provide short connections from roadways or off-street paths to important pedestrian destinations such as schools, parks, transit centers and mixed-use centers.

## 4. Steps in Addressing Bikeway & Trail System Gaps

This section describes the recommended procedure for addressing gaps on the Albuquerque walkway and bikeway networks. The procedure involves a series of sequential steps incorporating information described throughout this memo. Given the diversity of walkways, bikeways and other conditions, the City should consider the procedure a “living document” and remain open to flexibility to address unique circumstances. **Figure 10** graphically depicts the procedure discussed below.

## Gap Assessment Approach

### Step 1: Identify Gap Type

Identify the gap type (e.g., spot gap, connection gap, lineal gap, corridor gap, system gap).

### Step 2: Identify Appropriate Range of Gap Closure Measure Types

The type of gap determines the initial range of closure measure options. For instance, longer system gaps can be filled using nearly all gap closure measure types described in this chapter, while a limited range of measures are appropriate for shorter gaps such as spot and connection gaps. Use **Figure 7** and **9** to determine the initial range of options.

### Step 3: Determine Appropriate Location for Gap Closure Measures

The type of gap also determines the appropriate gap closure location. Due to their relatively short lengths, spot and connection gaps should be addressed specifically where they exist. Mentioned earlier, alternative routing measures are not an appropriate measure for addressing these gaps. Although addressing spot and connection gaps may prove challenging, they represent the most critical walkway and bikeway links. In general, the majority of bikeway gaps should also be addressed specifically where they exist. Cyclists should not be re-routed further than across a street, and then only temporarily during construction. However, gap closure measures should be prioritized in areas of the City where more cyclists, pedestrians, and trail enthusiasts are expected to be, i.e. along routes to schools or near mixed-use centers.

Lineal, corridor, and system bikeway gaps, typically covering longer distances, offer greater implementation flexibility. Bicyclists generally prefer direct travel routes, though they may tolerate route diversions to avoid long bikeway gap segments. Identifying the appropriate gap closure location for lineal, corridor, and system gaps involves evaluating the feasibility of adding bicycle facilities to the major street or trail corridor under focus versus the appropriateness of using alternative routes. The feasibility analysis should consider the following:

- Whether compelling ~~safety~~safety, operational, environmental, economic, or other reasons preclude bicycle facilities on the major street or multi-use trail corridor under focus
- Proximity of alternate route to the major street or multi-use trail corridor under focus
- Connectivity and continuity provided by the alternate route

The feasibility analysis will determine whether bicycle facilities should be added directly on the major street or multiuse trail corridor under focus, whether alternative routing is necessary, or both.

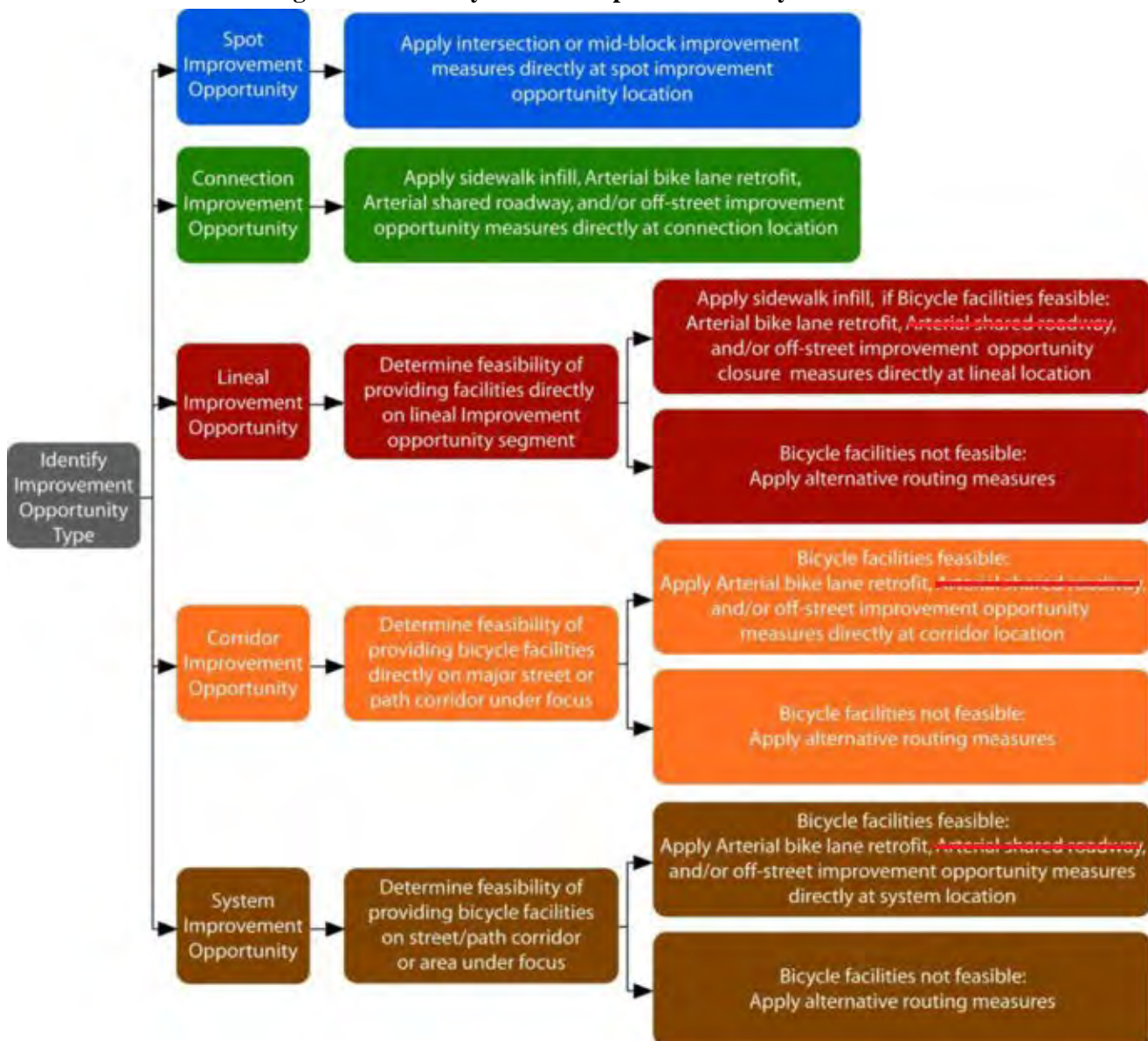
### Step 4: Determine Appropriate Gap Closure Measure Type

The appropriate gap closure measure type depends both on the walkway or bikeway gap type and location. Intersection improvement measures or mid-block crossings represent the most appropriate strategy for addressing spot gaps, while sidewalk infill, arterial bike lane retrofit, arterial shared roadway, and off-street gap closure measures represent the most appropriate strategies for closing connection gaps. Appropriate measures for lineal, corridor, and system gaps depend on the feasibility analysis referenced in Step 3.

### Step 5: Determine Specific Gap Closure Measure

Identification of the appropriate gap closure measure type and specific characteristics of the corridor/location under focus will help determine the appropriate specific gap closure measure.

**Figure 10: Bikeway & Trail Gap Closure Analysis Procedure**



**Step 6: Evaluation**

The City should gather data and public input as a means to further assess these topics and refine strategies and needs.

**5. Evaluation of Bikeway Connectivity – Link Connections and Gap Closures**

A review of the City’s current bikeways and trail system revealed several locations with poor connectivity or gaps between existing facilities. Some of the gaps exist because of limited right-of-way, or other challenges that would not allow a continuous facility. Closure of the gaps is beyond standard

planning practice and requires that engineering analysis be incorporated. As a result, 25 locations received further engineering evaluation and recommendations. The full text for these recommendations is included as **Appendix D.6, Gap Closure Engineering Analysis**. One location of concern is the East Central Avenue area, which has been studied by the City, and recommendations from the East Gateway Sector Development Plan helped form the recommendations. The Paseo del Norte/I-25 interchange area is another location identified as a challenging area ~~that lacks for~~ bicycle facilities. It is currently under design by the NMDOT as part of the Paseo del Norte and I-25 Interchange reconstruction project, which includes accommodations for non-vehicular access across I-25.

## **Bikeway Gap Closure Engineering Study Locations**

### ***Spot Gaps - Intersection Improvements (2 locations)***

1. Central Avenue and Yale Boulevard
2. Alameda Drain at 12th Street

### ***Lineal Gap Closure Engineering Evaluations (7 locations)***

3. Paseo del Norte/Paradise Boulevard - A portion of this gap will be addressed as part of the 50 Mile Loop project, which anticipates a paved trail along the Corrales Main Canal connecting the existing Paseo del Norte trail down to Eagle Ranch. A paved trail will be provided along Eagle Ranch Rd. to connect to the intersection with Coors Blvd. Some intersection enhancements are anticipated, which will help travelers access the existing trail along Eagle Ranch that is west of Coors Blvd.
4. Wyoming Boulevard/Utah Street
5. Montano Road/Montgomery Boulevard Corridor
6. Girard Boulevard Corridor
7. Lomas Boulevard/Easterday Drive
8. Lomas Boulevard/San Pedro Drive
9. Rio Grande Boulevard - City Council is in the process of evaluating options to close this gap.

### ***Corridor Gap Closure Engineering Evaluations (16 locations)***

10. East Central Avenue
11. Paseo del Norte (North Diversion Channel to I-25) - In conjunction with the I-25/Paseo del Norte Interchange reconstruction, trail and bikeway improvements are in process to address the gap between the east side of I-25 and the west side of Jefferson. They consist of a grade-separated bridge crossing I-25, with paved trail connections on either side. Future work will extend the trail along Headline, across Jefferson Blvd. at a lighted intersection, and north along Tiburon to connect to El Pueblo. Improvements along El Pueblo will occur as a future project.
12. Bridge Boulevard (Coors to Broadway) - Bernalillo County recently completed the Bridge Boulevard Corridor Plan, and is in the process of making multi-modal upgrades to close this gap.
13. Candelaria Road (12th Street to University)
14. San Pedro Drive (Zuni to Claremont) - A portion of this gap will be addressed as part of the current San Pedro Road Diet project, which will add bicycle lanes between Mountain Rd. and Haines Ave. Additional improvements to the parallel route, Alvarado Dr., as part of the 50 Mile



Loop project. It is anticipated that there will be a HAWK signal to assist with crossing Lomas Blvd.

15. San Mateo (Gibson to Ridgecrest)
16. Sequoia Road (Coors to Ladera Drive)
17. Indian School Road (Rio Grande to 12th Street) – This is a current DMD project.
18. Cutler Avenue (Washington to San Mateo)
19. Claremont Avenue as a Bicycle Boulevard (Richmond to Chelwood)
20. Alexander Boulevard (Comanche to Mission)
21. Montano Road (4th Street to 2nd Street)
22. Irving Boulevard (Universe to La Paz) – This is a current DMD project.
23. Washington Street (Lomas to Zuni)
24. Carlisle Boulevard (Garfield to Silver)
25. Second Street (Stover to Marquette)

## **B. Proposed Bikeway and Trail Facilities**

The *Bikeways & Trails Facility Plan* provides guidance for the development of an on- and off-street bikeway and trails network to accommodate bicycling and other non-motorized travel and recreation. Albuquerque currently has a well-developed bikeway and trail system that currently contains over 620 miles of trails, lanes, routes, and boulevards. Through implementation of this plan, the city will achieve a fully interconnected system.

The projects proposed by this Plan originate from many different sources, which are detailed below:

- *The Trails and Bikeways Facility Plan, 1993*
- *The Albuquerque Comprehensive On-street Bicycle Plan, 2000*
- *The Mid-Region Council of Governments (MRCOG) Long Range Bicycle Plan, 2011*
- Adopted Plans: Rank II (Area & Facility Plans) and Rank III (Sector Development Plans)
- Input from stakeholder workshops, user and agency interviews, public meetings, and the Greater Albuquerque Bicycling Advisory Group (GABAC) and the Greater Albuquerque Recreational Trails Advisory Committee (GARTC)
- Detailed analysis of the existing bikeway and multi-use trail system
- City of Albuquerque STIP planning & the Decade Plan (CIP planning)

It is recognized that all of the project recommendations contained in this plan will require further detailed study and design. On-street facilities will have to be designed with their impacts to intersections and road systems in mind and coordination with City Traffic Engineering would be required.

Some of the multi-use trails recommended in this plan would be contained within property owned by either the Albuquerque Metropolitan Arroyo Flood Control Authority (AMAFCA) or the Middle Rio Grande Conservancy District (MRGCD). Detailed analysis would be required to determine the feasibility of locating these trails within the rights-of-way for either entity. Furthermore, the design and construction of these trails would require considerable coordination and would have to go through the permitting and approval process for each respective entity.

## Project Prioritization Approach

The City uses an **opportunistic project prioritization approach**. The City recognizes the importance of both extending the network in newly developing parts of the city and also completing the challenging network gaps in the existing system. ~~However, rather than rely on a purely scientific or rational approach to determining the relative priority of projects, the City responds to opportunities as they arise. Generally, project criteria include safety, user comfort, system connectivity, completeness of network, barriers and constraints, and serving non-motorized needs. The City relies on scientific and rational approaches in determining the relative priority of projects and responds to opportunities as they arise.~~

The City's budget is allocated for specific departments to accomplish projects, programs, or capital infrastructure construction/rehabilitation. This is broadly allocated through the Decade Plan, also known as the Capital Implementation Plan (CIP). To maximize the investment in bikeways and trails, projects will be prioritized when there is the opportunity to leverage funds from different budgets, such as City Council set-asides or Metropolitan Redevelopment street improvement funds. A similar process would occur when there is the opportunity to collaborate with a project that is led by another agency, such as AMAFCA or NMDOT. In addition to the City's local funding allocation, state and federal funds for transportation projects are applied for through the Transportation Improvement Program (TIP). The MRCOG Project Prioritization Process identifies intermodal connectivity and alternate modes improvements, among other criteria, as a component of future project selection. This project ranking system encourages inclusion of multi-modal facilities in future project scope and design.

Staff from DMD, Parks and Recreation, Planning, and other agencies currently collaborate on an as-needed basis. It would be beneficial to form group that meets on a regular basis to discuss project selection, funding, and long-term strategies. Bikeways and trails advisory groups should also be directed to weigh-in on project priorities when developing future CIP and TIP project lists.

A final process where bikeways and trails are constructed is concurrently with adjacent development. Most of the network extensions are constructed through this process. The adjacent land owner is required to dedicate land and/or construct bikeway or trail facilities where they are identified on the map that is included in this Plan. The benefit of this process is that the system gets extended as new development occurs. A negative outcome of this development approach is that it sometimes leads to a fragmented network, such as along Irving Blvd. or Snow Vista Blvd. The City may initiate a road improvement project in cases like these to complete the final road section. Without an adopted plan in place, the project may neglect to include facilities that would complete a regional non-motorized transportation and recreation network. See Table 6 for infrastructure project evaluation criteria that could be used for future project prioritization. The criteria include safety, system connectivity, completeness of network, barriers and constraints, and serving non-motorized needs. Additionally, the City should regularly collect data and engage in public involvement as a means to further assess project priorities and refine system needs.

### High Priority Projects

To best guide the opportunistic project prioritization that is applied, this plan identifies two types of high priority projects. The first is "**Current Projects**," those that the City currently has funding to design or construct, and projects that are programmed in the Transportation Improvement Plan (TIP). The TIP is a

process facilitated by MRCOG that allocates NMDOT funds to local governments. These are the projects that have a high likelihood of being constructed in the next 5-10 years.

The second type of high priority projects is classified as “**Critical Links.**” The planning consultants identified 94 critical link projects based on input from City staff, stakeholder interviews, and three public open house meetings. These project priorities were re-evaluated in 2014 by the planning team that consisted of representatives from the Planning Department, Department of Municipal Development, and Parks and Recreation. This team reviewed the most up-to-date existing facilities map to identify gaps in the network. The community identified critical links was combined with the current gap analysis. **The project team then reviewed these to narrow down the projects that would bring the highest system value and that could be constructed with the next 15 years with our current rates of funding.**

It is also important to point out that in each of the two high priority categories there are both projects for new connections as well as enhancements and improvements to existing facilities. An example of these types of projects includes the Irving Blvd. road improvements, which will make a continuous bicycle lane, and the Claremont Bicycle Boulevard, which would upgrade an existing bicycle route into a bicycle boulevard.

## 1. Full Build-Out of the Bikeways & Trails Facility Plan

This *Facility Plan* proposes 425 miles of new bikeways and trails within the City of Albuquerque. They were developed through detailed analysis of the existing bikeway and multi-use trail system, projects recommended by previous plans, public input, stakeholder's recommendations and the *Facility Plan's* Goal to develop an interconnected and balanced bikeway system. All projects that were identified from the sources listed above are included in the *Full Build-Out of the Bikeways & Trails Facility Plan*. The present-day cost for these proposed projects based on the cost estimation assumption, described in **Chapter 4.B.3, Estimated Costs**, below, is **\$121,168,000**. This total does not reflect right-of-way costs.

At current levels of funding for capital projects, which is **approximately \$3 million per year**, the full build-out of the network will take approximately 50 years. These projects consist of the following:

### Summary of Proposed Facilities within the City of Albuquerque:

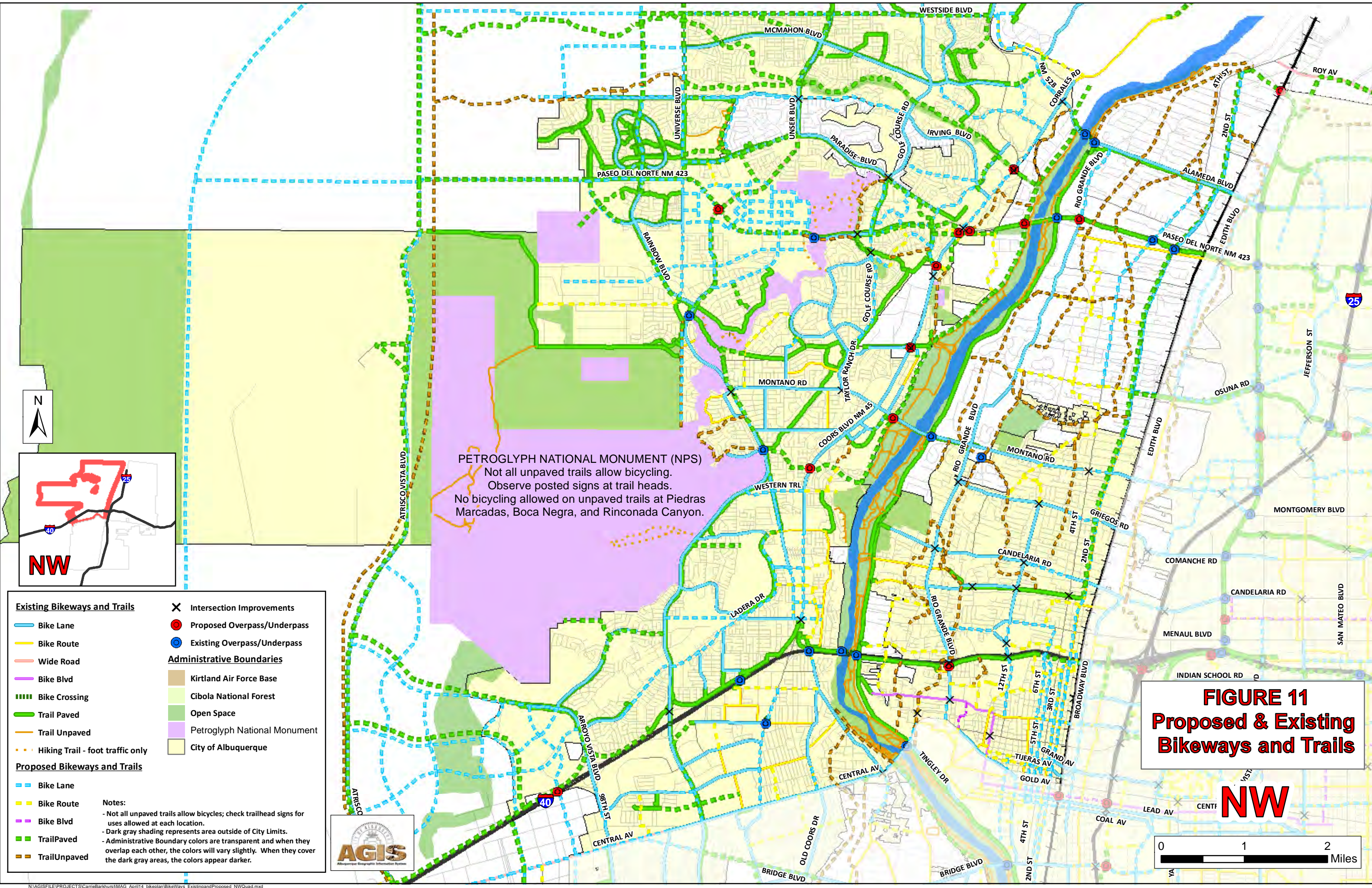
- Paved Trails – ~~115~~ 122 117 Miles
- Unpaved Trails – ~~45~~ 4337 38 Miles
- Bike Boulevards – ~~10~~ 111617 Miles
- Bike Lanes – ~~199~~ 196197198 Miles
- Bike Routes – ~~75~~ 767776 Miles
- Intersection Improvements – ~~87~~ 107
- Grade-separated Crossings – ~~16~~ 2825

A complete listing of these projects and a map of the complete build-out of the *Bikeways & Trails Facility Plan* is included as part of **Appendix A, Full Report of Proposed Facilities**.

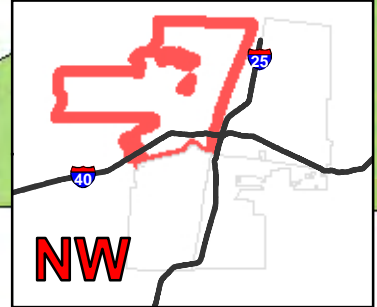








**PETROGLYPH NATIONAL MONUMENT (NPS)**  
 Not all unpaved trails allow bicycling.  
 Observe posted signs at trail heads.  
 No bicycling allowed on unpaved trails at Piedras Marcadas, Boca Negra, and Rinconada Canyon.



Existing Bikeways and Trails		Proposed Bikeways and Trails	
	Bike Lane		Bike Lane
	Bike Route		Bike Route
	Wide Road		Bike Blvd
	Bike Blvd		Trail Paved
	Bike Crossing		Trail Unpaved
	Trail Paved		Hiking Trail - foot traffic only
	Trail Unpaved		
	Hiking Trail - foot traffic only		

Administrative Boundaries	
	Intersection Improvements
	Proposed Overpass/Underpass
	Existing Overpass/Underpass
	Kirtland Air Force Base
	Cibola National Forest
	Open Space
	Petroglyph National Monument
	City of Albuquerque

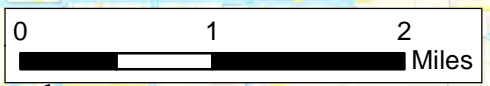
  

**Notes:**

- Not all unpaved trails allow bicycles; check trailhead signs for uses allowed at each location.
- Dark gray shading represents area outside of City Limits.
- Administrative Boundary colors are transparent and when they overlap each other, the colors will vary slightly. When they cover the dark gray areas, the colors appear darker.

**FIGURE 11**  
**Proposed & Existing**  
**Bikeways and Trails**

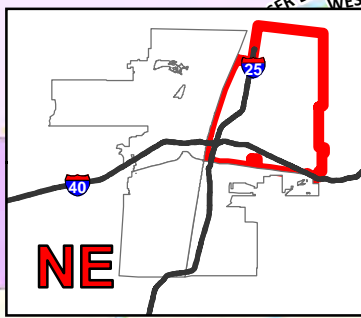
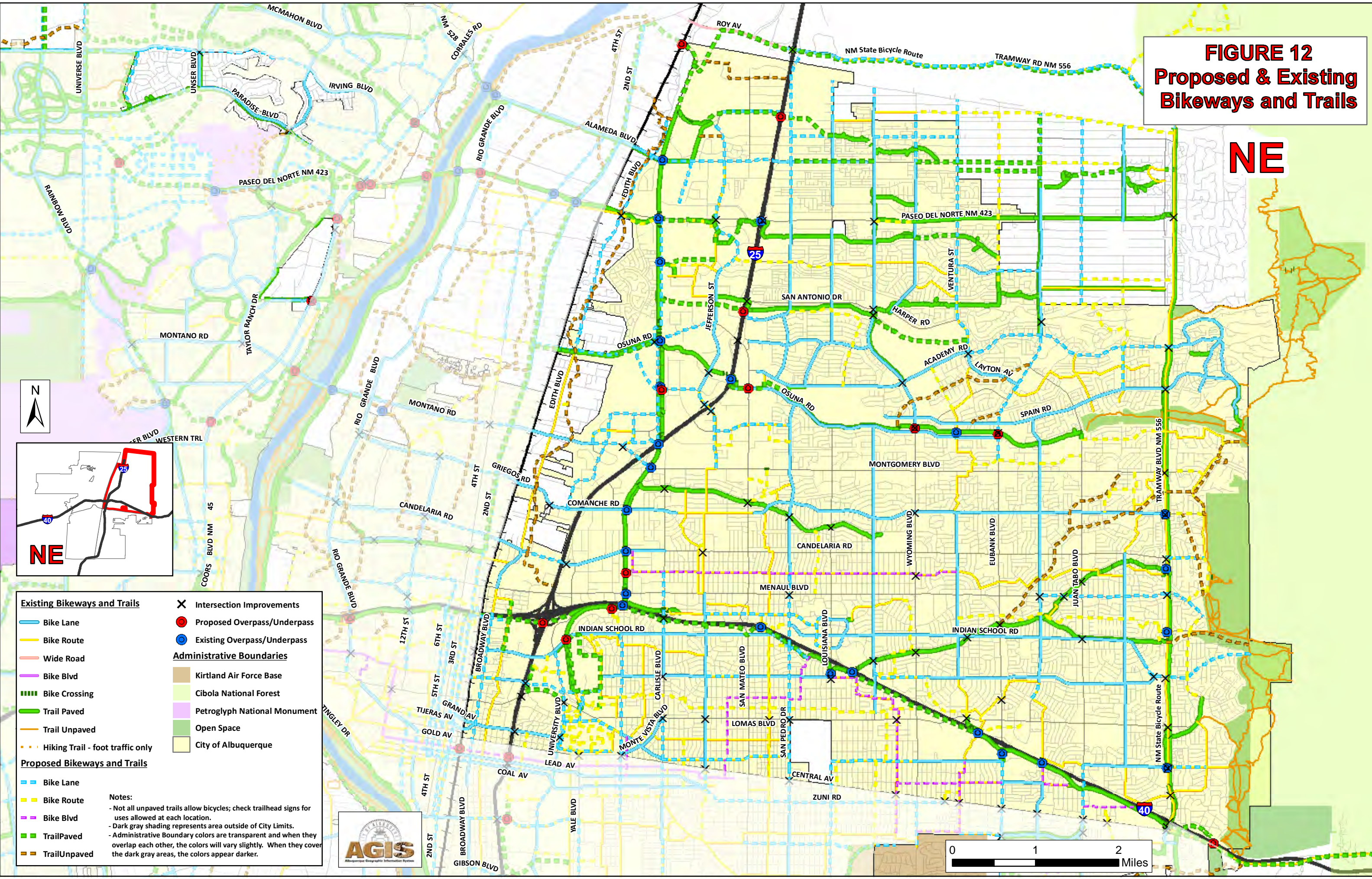
NW





**FIGURE 12**  
**Proposed & Existing**  
**Bikeways and Trails**

**NE**



<b>Existing Bikeways and Trails</b>		✕ Intersection Improvements
Bike Lane	Proposed Overpass/Underpass	Existing Overpass/Underpass
Bike Route	<b>Administrative Boundaries</b>	
Wide Road	Kirtland Air Force Base	Cibola National Forest
Bike Blvd	Petroglyph National Monument	Open Space
Bike Crossing	City of Albuquerque	
Trail Paved		
Trail Unpaved		
Hiking Trail - foot traffic only		
<b>Proposed Bikeways and Trails</b>		
Bike Lane		
Bike Route		
Bike Blvd		
Trail Paved		
Trail Unpaved		

**Notes:**

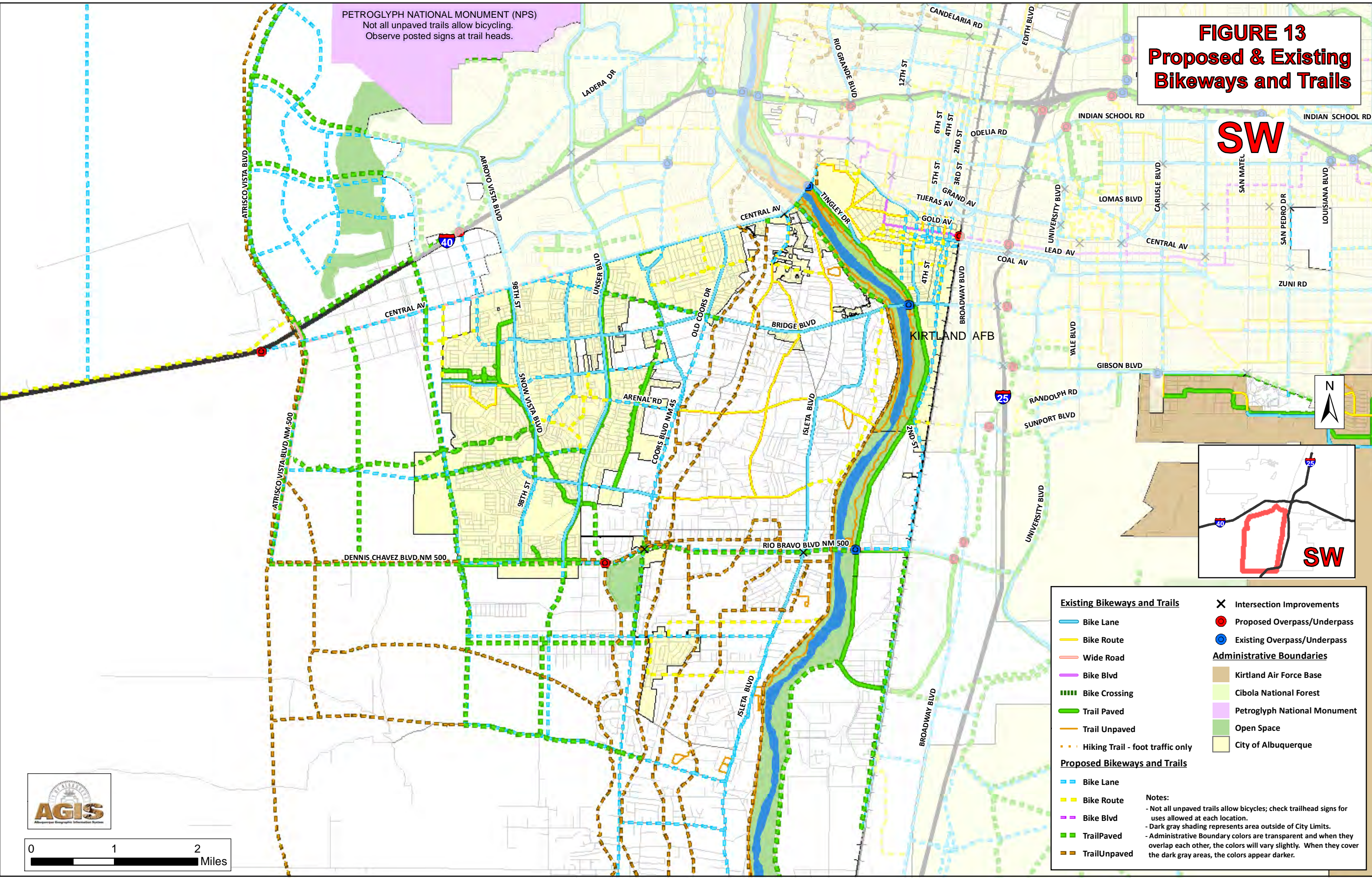
- Not all unpaved trails allow bicycles; check trailhead signs for uses allowed at each location.
- Dark gray shading represents area outside of City Limits.
- Administrative Boundary colors are transparent and when they overlap each other, the colors will vary slightly. When they cover the dark gray areas, the colors appear darker.



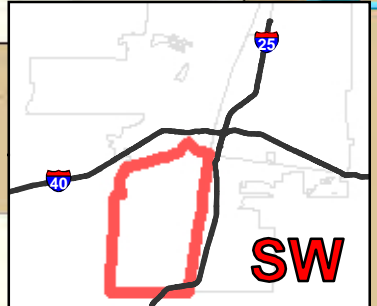


**FIGURE 13**  
**Proposed & Existing**  
**Bikeways and Trails**

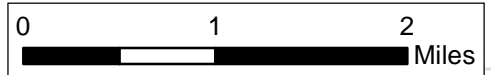
**SW**



PETROGLYPH NATIONAL MONUMENT (NPS)  
 Not all unpaved trails allow bicycling.  
 Observe posted signs at trail heads.



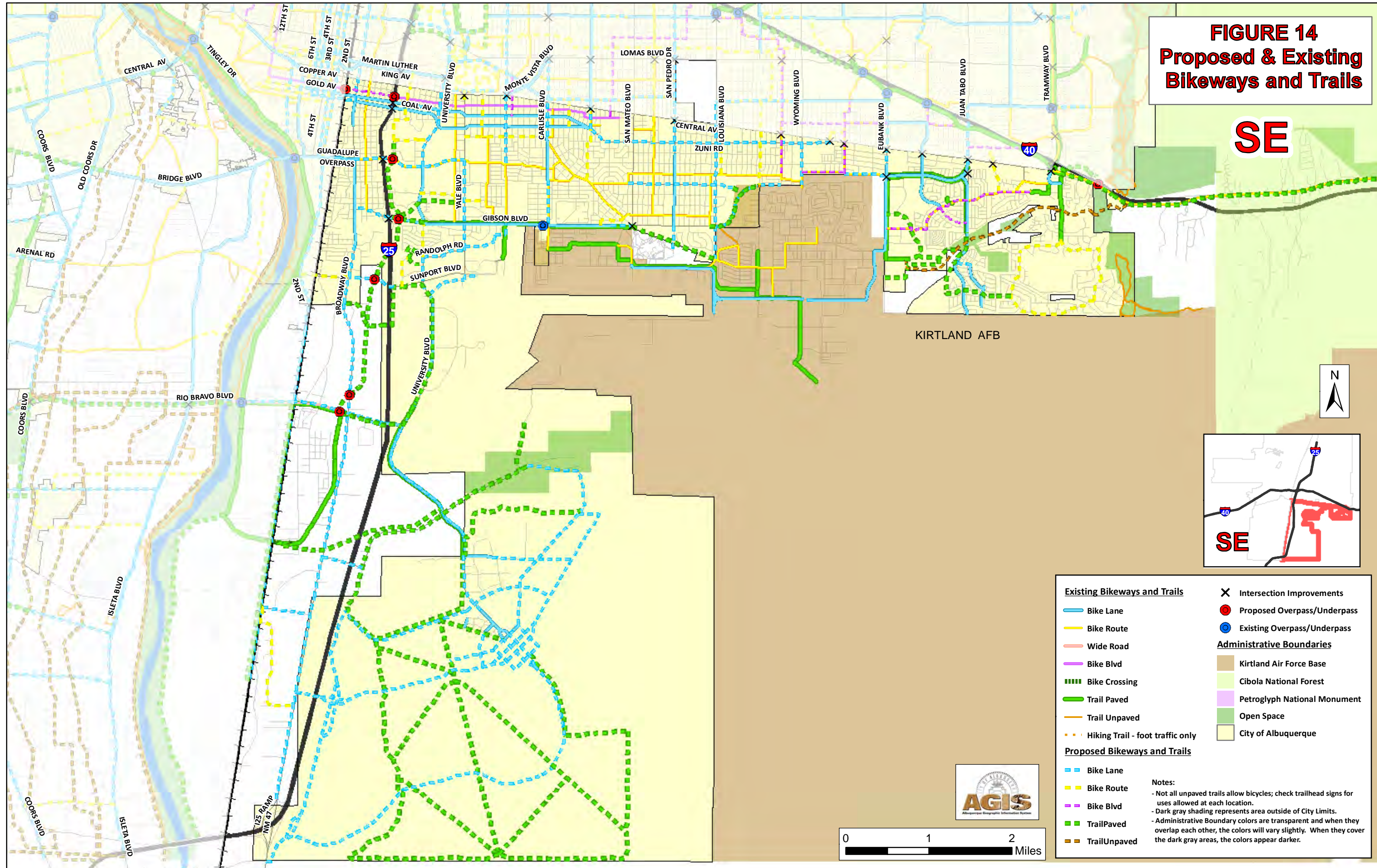
<b>Existing Bikeways and Trails</b>		<ul style="list-style-type: none"> <li>✕ Intersection Improvements</li> <li>● Proposed Overpass/Underpass</li> <li>● Existing Overpass/Underpass</li> </ul>
<b>Proposed Bikeways and Trails</b>		<p><b>Administrative Boundaries</b></p> <ul style="list-style-type: none"> <li>■ Kirtland Air Force Base</li> <li>■ Cibola National Forest</li> <li>■ Petroglyph National Monument</li> <li>■ Open Space</li> <li>■ City of Albuquerque</li> </ul>
<ul style="list-style-type: none"> <li>— Bike Lane</li> <li>— Bike Route</li> <li>— Wide Road</li> <li>— Bike Blvd</li> <li>— Bike Crossing</li> <li>— Trail Paved</li> <li>— Trail Unpaved</li> <li>— Hiking Trail - foot traffic only</li> </ul>	<ul style="list-style-type: none"> <li>— Bike Lane</li> <li>— Bike Route</li> <li>— Bike Blvd</li> <li>— Trail Paved</li> <li>— Trail Unpaved</li> </ul>	<p><b>Notes:</b></p> <ul style="list-style-type: none"> <li>- Not all unpaved trails allow bicycles; check trailhead signs for uses allowed at each location.</li> <li>- Dark gray shading represents area outside of City Limits.</li> <li>- Administrative Boundary colors are transparent and when they overlap each other, the colors will vary slightly. When they cover the dark gray areas, the colors appear darker.</li> </ul>



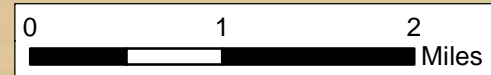


**FIGURE 14**  
**Proposed & Existing**  
**Bikeways and Trails**

**SE**

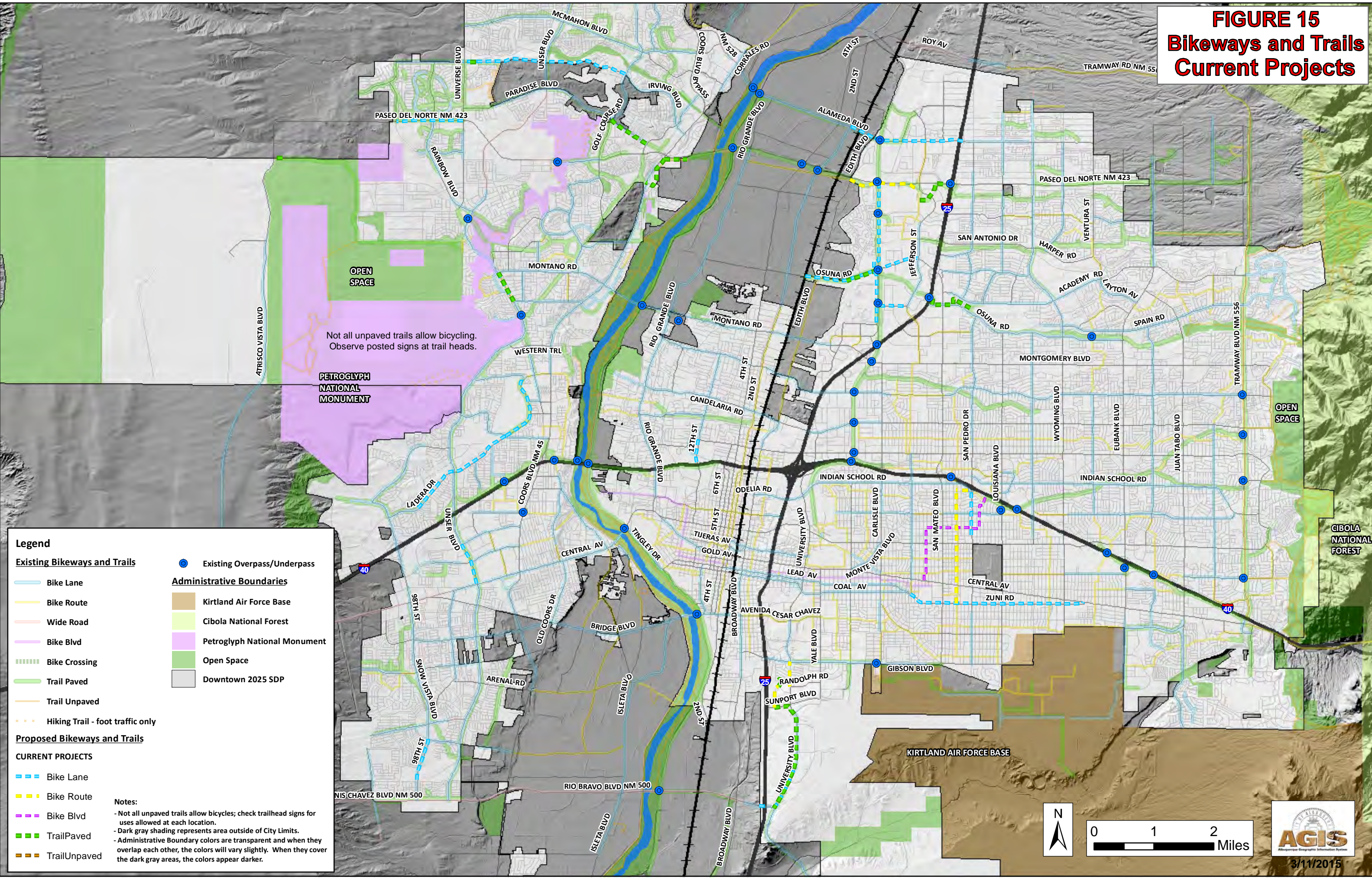


<b>Existing Bikeways and Trails</b>		<ul style="list-style-type: none"> <li>✕ Intersection Improvements</li> <li>● Proposed Overpass/Underpass</li> <li>● Existing Overpass/Underpass</li> </ul>
<ul style="list-style-type: none"> <li>— Bike Lane</li> <li>— Bike Route</li> <li>— Wide Road</li> <li>— Bike Blvd</li> <li>— Bike Crossing</li> <li>— Trail Paved</li> <li>— Trail Unpaved</li> <li>— Hiking Trail - foot traffic only</li> </ul>	<b>Administrative Boundaries</b> <ul style="list-style-type: none"> <li>■ Kirtland Air Force Base</li> <li>■ Cibola National Forest</li> <li>■ Petroglyph National Monument</li> <li>■ Open Space</li> <li>■ City of Albuquerque</li> </ul>	
<b>Proposed Bikeways and Trails</b>		
<ul style="list-style-type: none"> <li>— Bike Lane</li> <li>— Bike Route</li> <li>— Bike Blvd</li> <li>— Trail Paved</li> <li>— Trail Unpaved</li> </ul>	<b>Notes:</b> <ul style="list-style-type: none"> <li>- Not all unpaved trails allow bicycles; check trailhead signs for uses allowed at each location.</li> <li>- Dark gray shading represents area outside of City Limits.</li> <li>- Administrative Boundary colors are transparent and when they overlap each other, the colors will vary slightly. When they cover the dark gray areas, the colors appear darker.</li> </ul>	





**FIGURE 15**  
**Bikeways and Trails**  
**Current Projects**



**Legend**

**Existing Bikeways and Trails**

- Bike Lane
- Bike Route
- Wide Road
- Bike Blvd
- - - Bike Crossing
- Trail Paved
- Trail Unpaved
- - - Hiking Trail - foot traffic only

**Proposed Bikeways and Trails**

**CURRENT PROJECTS**

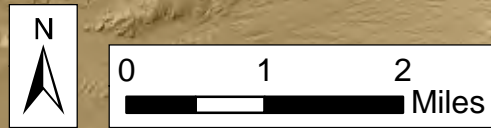
- - - Bike Lane
- - - Bike Route
- - - Bike Blvd
- - - Trail Paved
- - - Trail Unpaved

**Administrative Boundaries**

- Kirtland Air Force Base
- Cibola National Forest
- Petroglyph National Monument
- Open Space
- Downtown 2025 SDP

**Notes:**

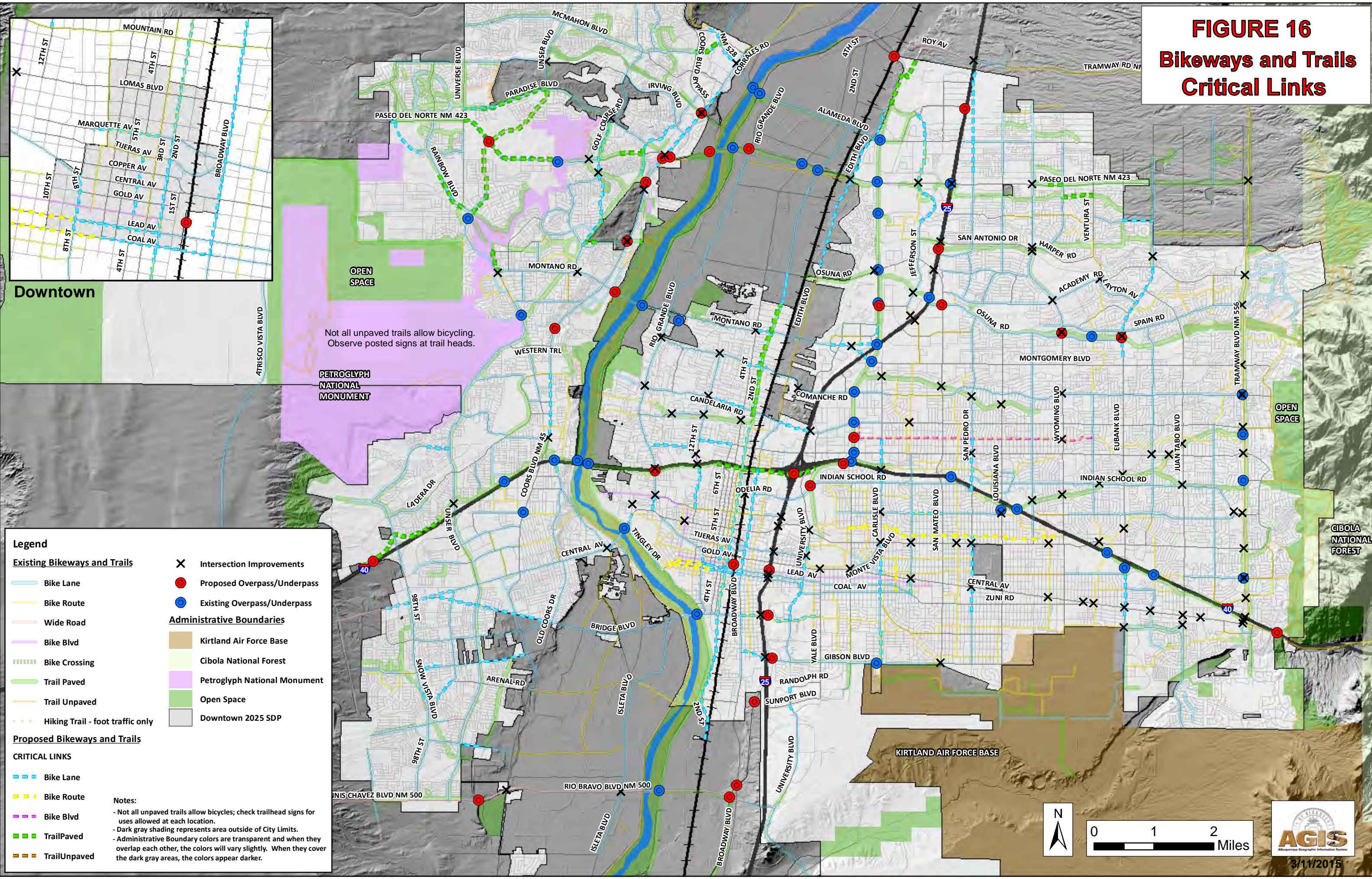
- Not all unpaved trails allow bicycles; check trailhead signs for uses allowed at each location.
- Dark gray shading represents area outside of City Limits.
- Administrative Boundary colors are transparent and when they overlap each other, the colors will vary slightly. When they cover the dark gray areas, the colors appear darker.



3/11/2015



**FIGURE 16**  
**Bikeways and Trails**  
**Critical Links**



**Downtown**

Not all unpaved trails allow bicycling. Observe posted signs at trail heads.

**Legend**

**Existing Bikeways and Trails**

- Bike Lane
- Bike Route
- Wide Road
- Bike Blvd
- Bike Crossing
- Trail Paved
- Trail Unpaved
- Hiking Trail - foot traffic only

**Proposed Bikeways and Trails**

**CRITICAL LINKS**

- Bike Lane
- Bike Route
- Bike Blvd
- Trail Paved
- Trail Unpaved

**Administrative Boundaries**

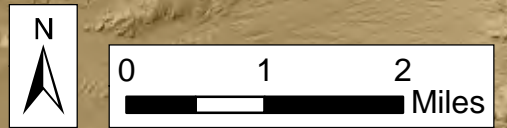
- Kirtland Air Force Base
- Cibola National Forest
- Petroglyph National Monument
- Open Space
- Downtown 2025 SDP

**Intersection Improvements**

- Proposed Overpass/Underpass
- Existing Overpass/Underpass

**Notes:**

- Not all unpaved trails allow bicycles; check trailhead signs for uses allowed at each location.
- Dark gray shading represents area outside of City Limits.
- Administrative Boundary colors are transparent and when they overlap each other, the colors will vary slightly. When they cover the dark gray areas, the colors appear darker.



3/11/2015



## 2. High-Priority Projects

### Current Projects

City Staff compiled a short list of projects, which are currently programmed or may already be in the design and/or construction phase. Current projects include approximately 2.4 miles of bike boulevards, 15 miles of bike lanes, 12 miles of multi-use trails and 3 miles of bike routes. The estimated cost for these projects is **\$8.0 million**. A detailed list of these projects is shown below; the map is on page 68. [The projects are listed in alphabetic order by City quadrant; the number does not reflect a relative priority.](#)

**Table 7: High-Priority “Current Projects”**

No.	Type	Name	From	To	Length
1	Trail	Corrales Main Canal	PdN Frontage Rd. NW	Eagle Ranch Rd. NW	0.34 mi.
2	Trail	Corrales Main Canal	Piedras Marcadas Arroyo	Paseo del Norte Blvd. NW	0.15 mi.
3	Trail	Paseo del Mesa Trail	Atrisco Vista Blvd. NW	Existing Paseo de la Mesa	0.15 mi.
4	Trail	Paseo del Norte NW	All Saints Rd. NW	Coors Blvd. NW	0.44 mi.
5	Lane	Paseo del Norte NW	W. City limit	Rainbow Blvd. NW	0.50 mi.
6	Lane	12 <sup>th</sup> Street NW	Bellamah Ave.	Menaul Blvd.	0.25 mi.
7	Lane	Channel Road NW	El Pueblo	Osuna Rd.	2.43 mi.
8	Route	El Pueblo Rd NW	Jefferson St.	Edith Blvd.	1.20 mi.
9	Lane	Quail Rd.	Alamogordo	57 <sup>th</sup> Street	0.38 mi.
10	Lane + Trail	Unser Blvd. NW	Dellyne Ave. NW	Montano Rd. NW	0.55 mi.
11	Lane	Alameda Blvd. NE	Pan American	Edith Blvd.	1.52 mi.
12	Trail	Bear Canyon Arroyo Trail NE	I-25 Frontage Rd.	Osuna	0.12 mi.
13	Trail	Bear Canyon Arroyo Trail NE	Brentwood	West end Arroyo del Oso Golf Course	0.84 mi.
14	Lane	Channel Rd. NW	El Pueblo Rd.	Mission Ave.	2.43 mi.
15	Lane	Osuna Rd. NE	Jefferson St.	Edith Blvd.	1.75 mi.
16	Trail	Osuna Rd. NE	North Diversion Channel	Sandia Prep HS	0.54 mi.
17	Trail	Paseo del Norte NE	North Diversion Channel	Domingo Baca Arroyo	1.97 mi.
18	Lane	Singer Blvd. NE	Jefferson St.	Chappel Dr.	0.49 mi.
19	Lane	2 <sup>nd</sup> Street SW	Claremont Ave.	Marquette	4.22 mi.
20	Route	Alvarado Dr. SE	Dakota St. SE	Zuni Rd. SE	2.07 mi.
21	Trail	Bobby Foster SE	University Blvd.	Los Picaros	1.81 mi.
22	Bike Blvd.	Fair Heights Bike Blvd.	Central Ave. NE	Zimmerman Ave. NE	2.40 mi.
23	Trail	La Semilla SE	Bobby Foster	Unnamed Paved Trail	1.99 mi.
24	Lane	Rio Bravo Blvd. SE	West of Empresa Dr. SE	I-25 Frontage Rd. SE	0.11 mi.
25	Trail	Sagan SE	La Semilla	Eastmen Crossing	0.91 mi.
26	Lane	San Pedro Dr. SE	Lomas Blvd. SE	Menaul Blvd. SE	1.50 mi.
27	Route	Sunport Interchange	University Blvd.	San Jose Drain	0.39 mi.
28	Trail	University Blvd. SE	Sunport Blvd.	Rio Bravo Blvd.	1.82 mi.
29	Lane	University Blvd. SE	Spirit Dr./Sunport	Rio Bravo Blvd.	0.70 mi.
30	Lane	University Blvd. SE	George Rd.	Randolph Rd.	0.53 mi.
31	Route	University Blvd. SE	Gibson Blvd.	Randolph Rd.	0.33 mi.
32	Lane	University Blvd. SE	Bobby Foster	Stryker	1.35 mi.
33	Lane	Zuni Rd. SE	Washington St. SE	Central Ave. SE	2.95 mi.

## **Other Current Projects**

### *The 50-Mile Activity Loop*

The 50-Mile Activity Loop is part of ABQ the Plan, Mayor Berry's long-term plan to invest in the future of Albuquerque. ABQ the Plan is about large-scale public projects that will increase quality of life for residents, enhance economic development opportunities, promote tourism, and spur private sector investments. By leveraging the City's on-going investments in its' approximately 200 miles of trails and 343 miles of bike lanes, routes and boulevards, the 50-Mile Activity Loop aims to bridge the gaps that have been challenging to complete.

The *50-Mile Loop Plan*, ~~conceived of~~[completed](#) in 2013, establishes an alignment for the 50-Mile Activity Loop and evaluates the existing infrastructure along the alignment. The Plan proposes improvements and enhancements to the existing infrastructure in need of improvement and gaps along the alignment in need of completion for all types of users. Approximately 17-miles of improvements are needed to complete the loop; the Plan describes an implementation approach and key stakeholders for each segment. The plan also proposes smaller "mini-loops" or connector trails that access local neighborhoods and increase overall connectivity and choices in transportation and recreation.

The *50-Mile Loop Plan* provides a proposed marketing plan for promoting the 50-Mile Activity Loop for health and wellness benefits for the residents of Albuquerque, identifying the 50-Mile Activity Loop as a way for tourists and residents to enjoy the City's unique destinations and to stimulate tourism and economic development. Finally, the Plan proposes a strategy and budget for implementation of the improvements and enhancements.

The full text of the *50-Mile Loop Plan* is incorporated by reference as part of the *Trails & Bikeways Facility Plan*; the executive summary is included as **Appendix B, 50-Mile Activity Loop Executive Summary**.

### *Fair Heights Bicycle Boulevard*

As of 2014, the City is working on a plan for a bicycle boulevard through the Fair Heights Neighborhood. The proposed route is from Zuni, north along Jefferson and Madison to Mountain. From Mountain the route continues east to California and Dakota, which connect to the Tom Bolack Urban Forest existing trail. The design plans to be developed will coincide with the development of the San Pedro Dr. Road Diet Assessment.

The project will take into account the findings obtained and recommendations produced from the Silver Ave. Bicycle Boulevard Evaluation. Design elements will include permanent signage and pavement markings, median improvements, and construction of a bicycle median refuge on principal arterials or other critical locations as recommended by the consultant.

### *Alameda Drain*

The MRGCD has authorized project funds for engineering and planning services to develop a Comprehensive Land Management and Multi-Use Corridor Plan for the Alameda Drain, from I-40 upstream to the Sandia Pueblo boundary. The intent is to work towards a three-way funding agreement between the MRGCD, Bernalillo County, and City of Albuquerque. The consolidated engineering and planning effort would assess infrastructure improvements and alternative maintenance techniques to allow for restoration of riparian habitat, ditch bank grasses, and native shrub and tree communities to transform the drain from a weed choked, elm tree growing, maintenance-intensive blight on the valley, to a community asset to be enjoyed by MRGCD constituents. Infrastructure improvements would

include assessment of uniform access control, crossing structure upgrades, management of storm water inflows and evaluation of storm water quality best management practices for storm water flows in the drain. Multi-use components would include assessment and locations of planned trails, park nodes, community gardens, and other public amenities. The MRGCD Funding would be contingent on matching funds from Bernalillo County and the City of Albuquerque. Both agencies have interest in this project to support their NEPA permitting and implementation of trails (\$1M currently funded), tree canopy restoration, future storm drain connections, and other elements as determined through a community planning process.



### [Open Space Projects](#)

The Open Space Division's current focus for future soft-surface trails is in areas of the East Mountains and Sandoval County properties including the John A. Milne / Gutierrez Canyon Open Space and the Golden Open Space. The goal is to construct approximately 10 miles of new trail in the Golden Property and 7 miles for the John A. Milne / Gutierrez Canyon Open Space. Because these trails are built largely with volunteer labor, it is expected that these trail networks will be completed within the next five years. Additionally, the OSD has been analyzing user created trails in the Sandia Foothills Open

Space to see which ones can be converted into official trails. The process of determining which trails can become official trails entails looking at whether the trail adds to the overall circulation of the trail system or if it is a redundant trail. The process also involves looking at the grades and the amount of erosion on the user trails and weighing the potential for adding erosional control features, such as drain dips, and rerouting severely eroded sections. (Drain dips are defined in the OSD trails design guidelines). If the trail can be converted to a sustainable condition (minimum maintenance required) or maintainable condition (trail may require regular maintenance every few years) then the OSD will consider designating it as official and add it to the overall MPOS trail network.

There is no set time frame for the process of adding official trails to the Sandia Foothills Open Space and the work will take place as time and resources allow. Additional sites that have been identified for future trails in MPOS include the Placitas Open Space and the Route 66 Open Space. However, extensive planning needs to be done before trail building in these areas can begin. Therefore, no dates have been set for when trail work in these areas will begin or when it will be completed.

### **Critical Links**

During stakeholder workshops and the public comment phase, a list of projects was created that reflect routes that are considered critical links in the City's bikeways system. The gap analysis process described in **Section 4.A.2** of this Plan was also completed to identify other key gaps in the system. Critical Links projects include approximately 4.2 miles of bike boulevards, 62 miles of bike lanes, 16 miles of multi-use trails and 5.5 miles of bike routes. The estimated cost for these projects is **\$26.7 million, excluding right-of-way acquisition costs**. A detailed list of these projects is shown below; the corresponding map is on



page 70. The following list identifies the high-priority critical link projects that could possibly be completed within the next 15 years, [at the current rate of investment \(approximately \\$3M per year\)](#)

[The projects are listed in alphabetic order by City quadrant; the number does not reflect a relative priority.](#)

**Table 8: High-Priority “Critical Links Projects”**

No.	Type	Name	To	From	Length
1	Bike Lane	12th Street NW	Bellamah Ave. NW	NW Menaul Blvd.	0.91
2	Bike Lane	Candelaria Rd. NW	2nd Street NW	10th Street NW	0.50
3	Bike Lane	Coors Blvd. Bypass NW	Ellison Dr. NW	Eagle Ranch Rd. NW	0.74
4	Bike Lane	Coors Blvd. NW	Paseo Del Norte NW	Alameda Blvd. NW	1.45
5	Bike Lane	Coors Blvd. NW	Central Ave.	Saint Joseph Dr. NW	3.38
6	Bike Lane	Eagle Ranch Rd. NW	Coors Blvd. NW	Irving Blvd. NW	0.62
7	Bike Lane	Ellison Dr. NW	Coors Blvd. Bypass NW	Cabazon Rd. NW	0.71
8	Bike Lane	Indian School Rd. NW	Menaul Extension NW	Rio Grande Blvd. NW	0.63
9	Bike Lane	Irving Blvd. NW	Golf Course Rd. NW	Rio Los Pino Dr. NW	1.40
10	Bike Lane	La Orilla Rd. NW	Sumac Dr. NW	Coors Blvd. NW	0.10
11	Bike Lane	Ladera Dr. NW	South of Tessa Dr. NW	Ouray Rd. NW	1.81
12	Bike Lane	Menaul Blvd. NW	6th Street NW	12th Street NW	0.55
13	Bike Lane	Montano Rd. NW	Gallegos Lateral NW	4th Street NW	0.26
14	Bike Lane	Atrisco Dr. NW / Rainbow Blvd. NW	Unser Blvd. NW	Existing bike lanes on Rainbow Blvd.	0.88
15	Bike Lane	Paseo Del Norte NW	NW City Limits	Rainbow Blvd. NW	0.74
No.	Type	Name	To	From	Length
16	Bike Lane	Rio Grande Blvd. NW	Central Ave. W	Mountain Rd. NW	0.25
17	Bike Lane	Tierra Pintada Blvd. NW	Windward Dr. NW	Unser Blvd. NW	0.32
18	Bike Lane	Unser Blvd. NW	Black Arroyo Blvd. NW	Bandelier Dr. NW	0.65
19	Bike Lane	Unser Blvd. NW	Ladera Dr. NW	Ouray Rd. NW	1.02
20	Bike Lane	Woodmont Ave. NW	Paseo Del Norte NW	Valle Prado Lane NW	0.67
21	Bike Lane	2nd Street NW	I-40 NW	Montano Rd. NW	2.31
22	Bike Lane	Paseo Del Norte NW	Calle Nortena NW	Rainbow Blvd. NW	1.76
23	Bike Lane	NM 528 NW	Coors Blvd. NW	Cottonwood Dr. NW	0.78
24	Bike Lane	Golf Course Rd. NW	Taylor Ranch Rd. NW	Paseo Del Norte Blvd.	1.55
25	Bike Lane	Marquette Ave. NW	7th Street NW	2nd Street NW	0.21
26	Bike Lane	Tierra Pintada Blvd. NW	Unser Blvd. NW	Arroyo Vista Blvd. NW	0.65
27	Bike Lane	Atrisco Dr. NW / Rainbow Blvd. NW	Unser Blvd. NW	Existing bike lanes on Rainbow Blvd.	1.22
28	Bike Lane	Atrisco Dr. NW	Iliff Rd. NW	Juniper Rd. NW	0.21
29	Bike Lane	Paradise Blvd. NW	Coneflower Dr. NW	Universe Blvd. NW	0.51
30	Bike Lane	2nd Street NW	Montano Rd. NW	City Limits NW	0.49
31	Bike Route	Paseo del Norte NW	All Saints Rd. NW	Coors Blvd. NW	0.20
32	Trail	Unser Blvd. NW	Bandelier Dr. NW	Contess Rd. NW	0.23
33	Trail	Unser Blvd. NW	Mojave St. NW	Montano Rd. NW	0.39
34	Trail	Unser Blvd. NW	Atrisco Dr. NW	Paradise Blvd. NW	2.66
35	Trail	I-40 Westbound NW	Unser Blvd. NW	City Boundary NW	0.85
36	Trail	Frontage Rd. NW	Alamo Rd. NW	Paseo Del Norte Blvd.	0.44
37	Trail	Calle Cuervo NW	Coors Blvd. Bypass NW	Cabazon Rd. NW	0.69

38	Trail	Corrales Main Canal	Piedras Marcadas Arroyo	Paseo del Norte Blvd.	0.10
39	Trail	Paseo Del Norte Trail	Rancho Sereno NW	Eagle Ranch Rd. NW	0.40
40	Bike Lane	Unser Blvd. NW	Central Ave. W	Los Volcanes Rd. NW	0.32
41	Bike Lane	5th Street NW	Coal Ave. SW	Indian School Rd. NW	0.10
42	Trail	Paseo Del Norte Trail	Kimmick Dr. NW	Calle Nortena NW	1.82
43	Trail	La Orilla Rd. NW	Coors Blvd. NW	City Limits NW	0.24
44	Trail	Paradise Trail	Calle Chamisa NW	Unser Blvd. NW	1.15
45	Trail	Alameda Drain/2nd St.	2nd Street NW	Montano Rd. NW	1.51
46	Trail	North Diversion Channel	Alameda Blvd. NW	N City Limits NW	1.01
47	Trail	All Saints Rd. NW	Coors Blvd. NW	Eagle Ranch Rd. NW	0.32
48	Trail	Alameda Drain/2nd St.	Montano Rd. NW	N City Limits NW	0.49
49	Bike Blvd	Claremont Ave. NE	Richmond Dr. NE	Moon St. NE	3.95
50	Bike Blvd	Richmond Dr. NE	Candelaria Rd. NE	Claremont Ave. NE	0.25
51	Bike Lane	Edith Blvd. NE	Paseo Del Norte Blvd.	Alameda Rd. NE	1.29
52	Bike Lane	Alameda Blvd. NE	Barstow St. NE	Edith Blvd. NE	0.09
53	Bike Lane	Candelaria Rd. NE	University Blvd. NE	Edith Blvd. NE	0.53
54	Bike Lane	Carlisle Blvd. NE	Central Ave. E	Lomas Blvd. NE	0.53
55	Bike Lane	Carlisle Blvd. NE	Indian School Rd. NE	Montgomery Blvd. NE	0.75
56	Bike Lane	Chappell Dr. NE	Singer Blvd. NE	Pan American Frwy. NE	0.32
57	Bike Lane	Comanche Rd. NE	Carlisle Blvd. NE	Drainage Easement NE	1.20
58	Bike Lane	Constitution Ave. NE	Stanford Dr. NE	Girard Blvd. NE	0.52
59	Bike Lane	Eubank Blvd. NE	Osuna Rd. NE	Academy Rd. NE	1.33
60	Bike Lane	Eubank Blvd. NE	Central Ave. NE	Chico Rd. NE	0.56
<b>No.</b>	<b>Type</b>	<b>Name</b>	<b>To</b>	<b>From</b>	<b>Length</b>
61	Bike Lane	Indian School Rd. NE	Monte Largo Dr. NE	Embudo Trail	0.85
62	Bike Lane	Jefferson St. NE	Masthead St. NE	San Francisco Dr. NE	0.86
63	Bike Lane	Louisiana Blvd. NE	Signal Ave. NE	San Diego Ave. NE	0.10
64	Bike Lane	Louisiana Blvd. NE	San Antonio Dr. NE	Burton NE	0.44
65	Bike Lane	Montano Rd. NE/ Mercantile Ave. NE/ Commerce Dr. NE	West of Renaissance Blvd. NE	Chappell Dr. NE	0.87
66	Bike Lane	Montgomery Blvd. NE	N Diversion Channel	Culture Dr. NE	0.40
67	Bike Lane	San Francisco Rd. NE	Holbrook St. NE	Eubank Blvd. NE	0.50
68	Bike Lane	San Pedro Dr. NE	San Bernardino Ave. NE	I25 Ramp / City Limits	2.11
69	Bike Lane	San Pedro Dr. NE	Zuni Rd. NE	Claremont Ave. NE	1.25
70	Bike Lane	Wyoming Blvd. NE	Alameda Blvd. NE	Beverly Hills/ City limits	0.16
71	Bike Route	Avenida La Resolana NE	Montclair Dr. NE	Morningside Dr. NE	0.07
72	Bike Route	Mackland Ave. NE	Lafayette Dr. NE	Montclair Dr. NE	0.50
73	Bike Route	Mackland Ave. / Summit Dr. NE	Summit Dr. NE	Lafayette Dr. NE	0.09
74	Bike Route	Marble Ave. NE	Vassar Dr. NE	Summit Dr. NE	0.22
75	Bike Route	Morningside Dr./ Marble Dr. NE	Utah St. NE	I-40 Ramp NE	0.18
76	Bike Route	Morningside Dr. / Marble Dr. NE	San Pedro Blvd. NE	Texas St. NE	1.29
77	Bike Route	Morningside Dr. / Marble Dr. NE	Avenida La Resolana NE	San Pedro Blvd. NE	1.34
78	Trail	Domingo Baca Drainage	Barstow St. NE	Ventura St. NE	0.52

79	Trail	Paseo Del Norte NE	Existing unnamed trail	Barstow St. NE	0.25
80	Trail	Ventura St. NE	Academy Rd. NE	Paseo Del Norte Blvd.	1.62
81	Bike Lane	86th St. SW	Camino San Martin SW	Sapphire St. SW	0.42
82	Bike Lane	8th St. SW	Bridge Blvd. SW	Lead Ave. SW	0.85
83	Bike Lane	Blake Rd. SW	Arenal Main Canal SW	Unser Blvd. SW	0.33
84	Bike Lane	Central Ave. SW	Sunset Rd. SW	Atrisco Dr.	0.17
85	Bike Lane	Coal Ave. SW	Broadway Blvd. SE	6th Street SW	0.53
86	Bike Lane	Coors Blvd. SW	Huseman Pl. SW	City Limits SW	0.08
87	Bike Lane	Sage Rd. SW	Unser Blvd.	Sunspot Rd. SW	0.92
88	Bike Lane	Snow Vista Blvd. SW	Camino San Martin SW	Benavides Rd. SW	0.22
89	Bike Lane	Lead Ave. SW	8th Street SW	2nd Street SW	0.41
90	Bike Lane	Central Ave. SW	City boundary SW	Coors Blvd. SW	1.16
91	Bike Lane	4th St. SW	Tijeras Ave. SW	Silver Ave. SW	0.29
92	Bike Lane	Central Ave. SW	Tingley Dr. SW	San Pasquale Ave. SW	0.81
93	Bike Lane	Broadway Blvd. SW	Indian School Rd. SW	Coal Ave. SW	1.74
94	Bike Lane	2nd Street SW	Near Lagunitas Ditch SW	Marquette Ave. NW	1.07
95	Bike Lane	Old Coors Blvd. SW	Bridge Blvd. SW	Coors Blvd. SW	0.01
96	Bike Lane	2nd Street SW	Claremont Ave. SW	Marquette Ave. SW	1.42
97	Bike Route	Alcalde Pl./Lead Ave. SW	SW ABQ Riverside Drain	8th Street SW	0.72
98	Bike Route	Coal Ave. SW	6th Street SW	Alcalde Pl. SW	0.65
99	Bike Lane	Old Coors Blvd. SW	Bridge Blvd. SW	Coors Blvd. SW	0.01
100	Trail	I-40 Overpass	1st Street SW	N Diversion Channel	1.55
101	Bike Lane	2nd Street SE	Near Lagunitas Ditch	Marquette Ave. NW	1.83
<b>No.</b>	<b>Type</b>	<b>Name</b>	<b>To</b>	<b>From</b>	<b>Length</b>
102	Bike Lane	Ave. Cesar Chavez SE	Edith Blvd. SE	Yale Blvd. SE	1.32
103	Bike Lane	Bridge Blvd. SE / Avenida Cesar Chavez SW	Central Ave. SW	Old Coors Dr.	2.10
104	Bike Lane	Carlisle Blvd. SE	Central Ave. E	Garfield Ave. SE	0.39
105	Bike Lane	Carlisle Blvd. SE	Carlisle Pl. SE	Gibson Blvd. SE	0.56
106	Bike Lane	Eubank Blvd. SE	Southern Ave. SE	Central Ave. E	0.34
107	Bike Lane	Gibson Blvd. SE	I-25 Ramp SE	Broadway Blvd. SE	0.33
108	Bike Lane	University Blvd. SE	Avenida Cesar Chavez SE	Las Lomas Rd. SE	1.34
109	Bike Lane	University Blvd. SE	George Rd. SE	Randolph Rd. SE	0.32
110	Bike Lane	Washington St. SE	Central Ave. E	Zuni Rd. SE	0.26
111	Bike Lane	Gibson Blvd. SE	I-25 SE	I-25 Ramp SE	0.10
112	Bike Route	Morningside Dr. SE	Silver Ave. SE	Coal Ave. SE	0.20
113	Bike Route	University Blvd. SE	Randolph Rd. SE	Gibson Blvd. SE	0.09

### 3. Estimated Costs

The construction costs of the proposed projects are to be considered “planning level” estimates. Unknown or unanticipated aspects unique to a specific facility may not have been accounted for and may increase the estimated cost. For planning purposes these costs indicate what the typical project can be reasonably expected to cost in terms of 2014 dollars. To reduce implementation costs, efforts should be made to include bicycle facilities in all new and rehabilitation projects. This has been an on-going City practice that should continue.

Costs include in the estimate for each of the following facilities are as noted below:



**Multi-use Paved Trails:** Trail paving; signs; pavement markings; minor landscaping; way-finding signs/pavement marking. Right-of way acquisition has not been factored in. **\$195,000/mile**

**Unpaved Trails:** Trail construction. Right-of way acquisition has not been factored in. **\$5,000/mile**

**Bicycle Boulevard:** No anticipated change in roadway surface or cross-section; some traffic calming; Bicycle Boulevard signs/pavement markings; stop sign relocation; way-finding signs. **\$50,000/mile**

**Bike lanes:** Cost depending on the existing/proposed cross-section can vary greatly. For estimation purposes a blended or averaged cost for roadways that require moving of curb line or a “road diet” to obtain the required cross-sections is used. **\$374,000/mile**

**Bike Routes:** No anticipated change in roadway surface or cross-section; bike route signs; way finding sign/pavement markings. **\$5,000/mile**

**Grade separated crossings:** Cost of these crossings vary depending on the length and type chosen. **\$1,500,000/crossing**

**Enhanced intersection:** May include pavement marking; signs; traffic signal detection; colored bike lanes. **\$10,000/intersection**

**HAWK / Pedestrian Hybrid Beacon:** A mid-block, pedestrian activated signal to control traffic. According to the ITE, costs range from \$75,000 to \$150,000 per signal. \$100,000/signal

**Right-of-Way:** The costs related to acquisition of right-of-way will vary depending on the relative cost of land and the amount of right-of-way needed. Recent costs in 2014 generally have ranged from \$4 - \$8 per square foot. Using this range, a mile of right-of-way could cost between \$100,000 and \$425,000. Right-of-way acquisition **is not included** in the above estimates for each facility type. Because many of the missing gaps are due to limited right-of-way, it is understood that the following cost estimate is more reflective of the minimum possible expense.

**Table 9: Full Build-Out Cost Estimate**

Bikeways & Trails	Proposed (mi.)	Cost/Mile	Total
Multi-Use Trails	<u>122-117</u> miles	\$195,000	<b>\$22,815,000</b>
Unpaved Trails	<u>3738</u> miles	\$5,000	<b>\$190,000</b>
Bike Boulevards	<u>1617</u> miles	\$50,000	<b>\$850,000</b>
Bike Lanes	<u>197198</u> miles	\$374,000	<b>\$74,052,000</b>
Bike Routes	<u>7776</u> miles	\$5,000	<b>\$380,000</b>
Grade-Separated Crossings	<u>2825</u> each	\$1,500,000	<b>\$37,500,000</b>
Enhanced Intersection	<u>107-91</u> each	\$10,000	<b>\$910,000</b>
<u>HAWK/Pedestrian Hybrid Beacon</u>	<u>16</u> each	<u>\$100,000</u>	<u>1,600,000</u>
<b>Total System Proposed Facilities</b>	<b>449446</b> miles	n/a	<b>\$138,297,000</b>

## C. Existing Facility Enhancements

### 1. Intersection and Crossing Improvements

This *Facility Plan* recommends improvements to intersections and crossings for the existing and proposed bikeways and multi-use trails. This *Facility Plan* recommends the construction of 15-1625

grade-separated crossings, improvement of ~~one~~ 16 mid-block crossings, and the improvement of ~~87~~ 96 existing intersections. The cost for these proposed intersection and crossing improvements based on the assumptions described above is ~~\$2124,880,000~~ \$26,560,000 \$40,010,000.

Funding available over the next 20-50 years will not be sufficient to construct all of the proposed projects and intersection improvements. The list of projects and improvements that this *Facility Plan* recommends should be used as guidance for the City when planning future work and/or requesting funding to expand the City’s roadway system. The City should complete a detailed study and prioritization plan to address the 87-91 intersections enhancements and 16 enhanced signal locations that were identified in the engineering study associated with this *Facility Plan* as well as additional intersections and mid-block crossing locations identified by GABAC and GARTC.

A “Prototypical Multi-lane Arterial Intersection Improvements” design recommendation was developed that incorporates traffic signal bicycle detection and a color enriched bike lane in motor vehicle/bicycle conflict areas. As funding allows, the City will apply this prototypical design to all of the 87 intersections identified in this planning process and will continue addressing other intersections with gaps in bicycle facilities. Each intersection that is adjacent to new bicycle facilities should be designed to accommodate a continuous facility through the intersection, as proposed in **Chapter 7, Design Manual**, and described below.



Generally, the goal is to make intersections more comfortable for cyclists. Include elements such as color, signage, medians, signal detection, and pavement markings. The level of treatment required for bicyclists at an intersection will depend on the bicycle facility type used, whether bicycle facilities are intersecting, the adjacent street function and land use. See the NACTO design guidelines and the 2012 AASHTO Guide for the Development of Bicycle Facilities for recommended intersection treatments.

## Prototypical Multi-lane Arterial Intersection Improvements

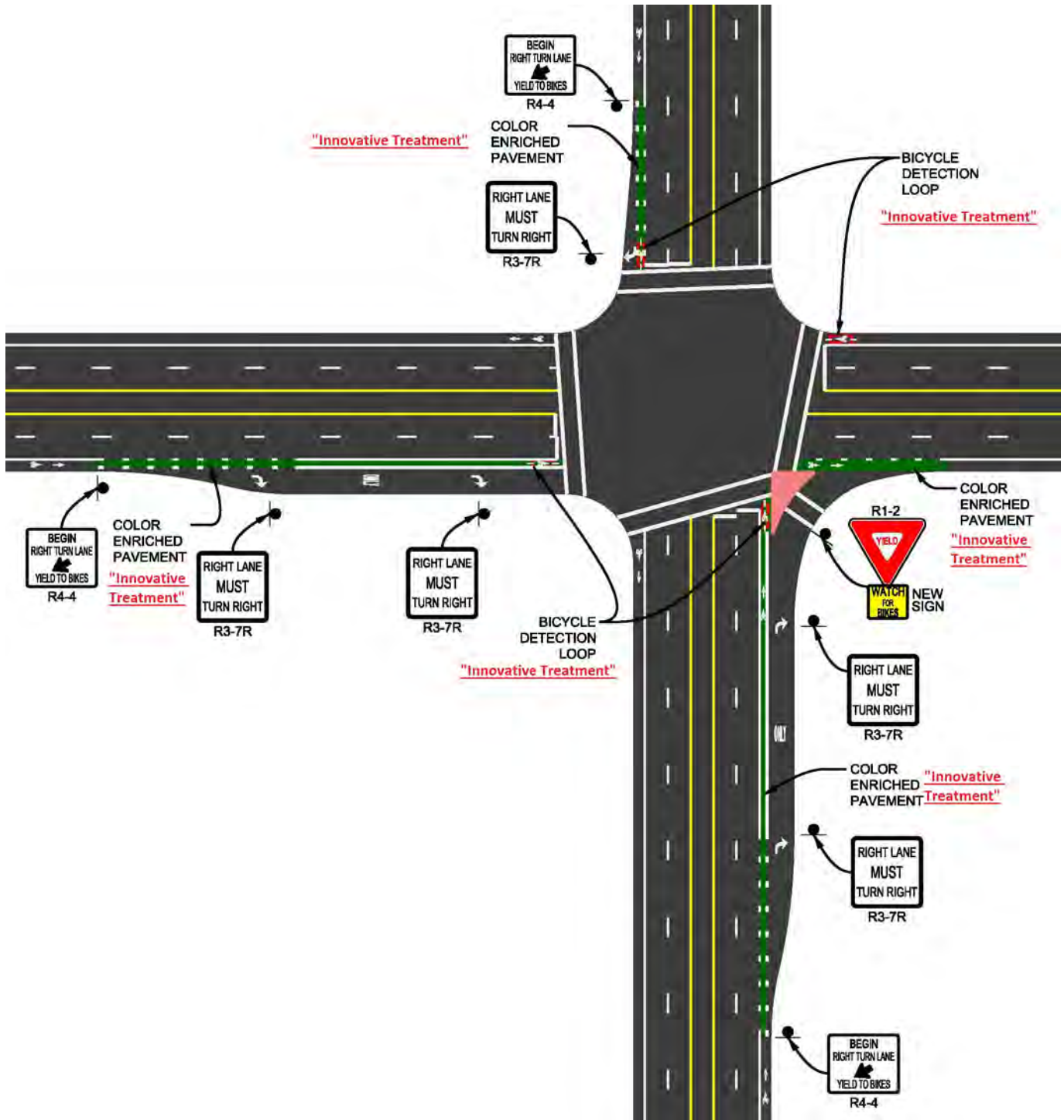
The following diagram shows **potential treatments to accommodate bicycle lanes on multi-lane arterial streets**. Four different intersection approaches are shown:

- Dedicated right-turn bay (west leg)
- Right-turn slip lane with yield condition (south leg)
- Combination right-turn/through lane with bike lane on the right side (east leg)
- Shared bike/right-turn lane (north leg)

Traffic signal bicycle detection is a part of each treatment, as is color enriched bike lanes in locations where motor vehicle traffic crosses over the bike lane. The four different intersection approaches are illustrated below. The description above begins with the intersection approach on the left side of the image and addresses each intersection approach in a counter-clockwise manner.



Figure 1217: Prototypical Multi-lane Arterial Intersection Design



## 2. Retrofitting Trails to Be Universally Accessible

As of 2014, the City of Albuquerque has begun a major program to evaluate trails along with parks to assess the current level of accessibility of these facilities. There is not yet a definite timeline for completion of the analysis as the program requires new training efforts.

Additionally, the quantity of parks and miles of trails to evaluate is extensive.

The City's goal is to make as many facilities accessible as possible. There will be parks and trails that are not suitable to be accessible for physical, financial, property ownership, or other reasons. Therefore, not every park and not every trail will be fully accessible throughout the City's trails system.

The proposed Architectural and Transportation Barriers Compliance Board (Access Board) Guidelines for Shared Use Paths are unique, as the Shared Use Paths are designed for recreational as well as for transportation use. The proposed guidelines will apply to the design, construction, and alterations of pedestrian and bicycle facilities in the public right-of-way and were not addressed in the previous Access Board rulemaking.

The Guidelines will be adopted as City Standards for accessible trails and will be incorporated into the City's Development Process Manual (DPM) once they are approved and available.



## 3. Bollard Assessment & Remediation

In 2013, the City commissioned a report to identify relevant design criteria for bollards on multi-use trail facilities, review the installation of bollards on multi-use trails at several locations identified by the City, and develop best practices for implementation by the City of Albuquerque. The report performed bollard evaluations at 4 specific locations along the Bear Canyon Arroyo Trail and at the Gail Ryba Bridge and recommended design changes to improve consistency with AASHTO and MUTCD recommendations.

**Common problems associated with bollards and multi-use trail facilities in Albuquerque include the following:**

- Bollards [may](#) present a collision hazard when placed on a multi-use trail.
- Inconsistent installations lead to user confusion and do not meet a consistent user expectation.
- Inadequate spacing between bollards results in users being unable to access facilities, and do not comply with ADA guidance.
- Removable bollards are illegally removed from their locations when not locked.
- When not in place, removable bollards have a collar that becomes a trip hazard.

- When bollards are not in place, unauthorized motorized vehicles may access multi-use facilities.

The assessment noted that bollards are a commonly used method of controlling vehicular access to multi-use trails. However, according to the AASHTO Guide for the Development of Bicycle Facilities, 2012, the routine use of bollards and other similar barriers to restrict motor vehicle traffic is not recommended.

The goal of bollards should be to balance the need to discourage unauthorized motorized vehicle access on a trail with the need to provide the trail users a facility without unnecessary obstructions. Therefore, developing a series of best practices for the installation of bollards on the City of

Albuquerque trail system is critical for the purpose of not only providing consistency within the trail system, but also establishing a level of expectancy with the trail users that will result in less confusion and improvements in accessibility for all types of users.



There are no standards or recommended guidelines that have been established to identify a threshold for what constitutes a history of unauthorized motorized vehicular use on a multi-use trail. The City does not have a policy to govern the design and installation of trail bollards to ensure consistent application. The City has installed bollards at numerous locations throughout the trail system to control vehicular access on trails. The only City Standard Drawing established for bollard installation pertains to an installation for access to a drainage facility.

The 2013 assessment identifies national and local recommended design practices but does not provide or recommend design standards. These best practice recommendations have been incorporated into this *Facility Plan's Chapter 7, Design Manual*. The full assessment is included as **Appendix C, Bollard Study**.

## 4. Facility Upgrades

### Claremont Road—Bicycle Route to Bicycle Boulevard

Claremont Road is [an example of a](#) road proposed to be upgraded from a Bicycle Route to a Bicycle Boulevard. As of 2014, the City is in the process of evaluating the success of the Silver, Mountain, and 14th Street Bicycle Boulevards to inform future installations. The Claremont route is a future project, and it is not currently under study or design.

Generally, the City should expand the system of bicycle boulevards utilizing quiet neighborhood streets that creates an attractive, convenient, and comfortable cycling environment welcoming to cyclists of all ages and skill levels.





## Trail Amenities

Trail amenities should be equitably distributed City-wide where feasible and as funding is available. Amenities will be prioritized by standards to be established in a future effort. Typical amenities to be provided could include:

- Bike racks at trailheads and rest stops
- Rest stops along paths with seating; shade structures at key locations
- Water fountains where feasible
- Signage to identify location within the trail system, directions to

community centers and facilities, and historic and interpretive signage

- Mile markers for way-finding
- Bike parking and bike lockers at destinations and connection points to other transportation modes, i.e. bus stops, train stations, employment centers
- Appropriate landscaping along trails

The Parks and Recreation Department will review and approve plans for landscaping along the trails. Installation of trail amenities and landscaping should be consistent with the recommendations provided in **Chapter 7, Design Manual**.

## D. Way-finding

Way-finding for cyclists and other trail users can be a challenge. Knowing where you are on the multi-use trails sometimes is difficult due to the lack of a standardized location identification system. Marking of the on-street bikeways and multi-use trails with way-finding will provide the users an effective way to identify where they are and direct them to where they wish to go. **A standardized facility naming and marking program was developed for this plan, which is contained in the Design Manual, Chapter 7.E.2, Trail Way-finding.** The criteria for laying out this program are based on the needs of pedestrians and other trail users as well as bicyclists. Law enforcement and emergency responders can use this information in finding locations of incidents on the multi-use trails accurately. The existing multi-use trail system can be upgraded to include way-finding, and all newly constructed facilities can include way-finding as part of their design. [See Chapter 3.C.5, Bikeway & Trail System, Way-finding and Orientation for more information on this topic.](#)

### 1. Signage and Marking

Marking of the on-street bikeways and way-finding on multi-use trails will provide users an effective way of identifying where they are and direct them to where they wish to go. Marking and maintenance of the markings for the existing bikeway and trail system will be a combined effort undertaken by Street Maintenance Division for the on-street portion and by Parks and Recreation Maintenance for the multi-use trail portion. The Open Space Division has a separate protocol “way-finding” [program for the Sandia Foothills Major Public Open Space and along the Paseo del Bosque, and is working to develop way-finding systems for trails within other Major Public Open Space areas.](#) Implementation of signage requires coordination with Street Maintenance for consistency of the Bikeways and Trails system. Newly constructed facilities will include way-finding as part of their design and be included as part of the facility construction.

As of 2014, the City is developing a Bicycle Corridor and Way-finding Sign Implementation Plan. The goal of the project is to improve way-finding and navigability for non-motorized travelers throughout the city. The City’s consultant first identified bicycle destination sites, such as the North Diversion Channel, Bosque Trail, University of New Mexico, Balloon Fiesta Park, and hospitals. This list of destinations was reviewed and discussed with GABAC members to gain input on any additional bicycle destination sites or corridors. Once the project develops a prioritized list of destination sites and corridors, the consultant will develop way-finding signs for the destination sites and corridors. One product of this project is a geographic database of proposed way-finding sign locations along the various corridors.

### 2. Emergency Responders

The City needs to coordinate with emergency responders with regards to the way-finding. The Trails Coordinator should spearhead this effort due to the greater impact the multi-use trail system [due to the greater impact on or to the multi-use trail system.](#) As part of this Facility Planning process, the Trails Coordinator developed a trail responsibility map. This map will be shared with the City’s 311 phone service and with emergency responders, once all trails have been given names and orientation features. Implementing on-the-ground signage or trail markings will be critical for the trail users to be able to communicate to emergency responders about their location. [The signage and markings also allow 311 calls to report more exact locations of trail maintenance problems, which may cause collisions or injury.](#)

## **CHAPTER 5: RECOMMENDED PROGRAMS**

Improvements to bikeway and trail facilities in Albuquerque should be complemented by programs and activities designed to promote bicycling and trail use. There are many existing efforts to encourage bicycling in Albuquerque, including efforts by local agencies, active community groups, and individual residents. The *Bikeways & Trails Facility Plan* recognizes these efforts and encourages the City and local residents to support, promote, and build upon them.

[The League of American Bicyclist/Bicycle Friendly Community Program \(BFC\) has recognized Albuquerque as a city that welcomes cyclists by providing safe accommodation for cycling and encouraging people to bike for transportation and recreation.](#)

[In 2005 the City of Albuquerque was recognized with the Bronze level award and is one of three cities in New Mexico recognized as a Bicycle Friendly Community \(Santa Fe—Silver, Las Cruces—Bronze\). The City maintains the Bronze standing as of 2014.](#)

[To be considered a Bicycle Friendly Community the City had to submit an audit of the five E's: engineering, education, encouragement, enforcement, and evaluation efforts in the city. This comprehensive inquiry is designed to yield a holistic picture of the community's work to promote bicycling.](#)

The following describes ~~current safety, education, outreach, and encouragement~~ [the City's](#) efforts related to bicycling and trail use in Albuquerque and presents a menu of recommended new and expanded programs to continue to promote bicycle and trail use.

### **A. Current ~~Safety, Education, & Encouragement~~ Programs**

There are many existing efforts to encourage bicycling in Albuquerque, including efforts by local agencies, active community groups, and individual residents. [Programs are typically classified as supporting one of the "5 E's" - Education, Encouragement, Engineering, Enforcement, and/or Evaluation.](#) The City, with the support of local bicycling groups, offers a number of valuable materials and programs aimed at bicyclists and trail users. Eight established groups have been identified as being actively involved in bicycle education, outreach and encouragement in the metropolitan area: Greater Albuquerque Bicycle Advisory Committee (GABAC), Greater Albuquerque ~~Regional-Recreational~~ Trails Committee (GARTC), Bicycle Coalition of New Mexico, BikeABQ, Sandia Bike Commuters Group, Duke City Wheelmen Foundation, New Mexico Touring Society, and Women's Mountain Bike and Tea Society.

This section is organized into two parts:

- City of Albuquerque Current Bicycling & Trail Programs
- Partnerships & Programs to Encourage and Support

#### **1. City of Albuquerque Bicycling & Trail Programs**

##### **Printed Materials (Outreach, Education)**

The City has several ongoing efforts that support bicycling and trail use, including the maintenance of a website dedicated to bicycling and the production of a comprehensive bicycle map.



- City of Albuquerque Metropolitan Albuquerque Bicycle Map: <http://www.cabq.gov/bike/documents/pdfs/2007ABOBikeMap.pdf>
- Bosque Trail Map: <http://www.cabq.gov/parksandrecreation/openspace/lands/RGVSPmapsplit11x17.pdf>
- Sandia Foothills Trails Map: <http://www.cabq.gov/openspace/pdf/foothillsmap.pdf>

A series of trail user guides are posted at <http://www.cabq.gov/bike> that map out scenic routes and identify landmarks along the way. Many of the routes primarily rely on trails that provide an experience of the city that is separate from motor vehicles. The City also has a trail etiquette guide titled “Let’s All Share.”

### **Bicycle Safety Education Program (Education, Encouragement)**

The City’s Bicycle/Pedestrian Safety Education Program (~~B&PSEP-Program~~) began in 1995 with a mission to design and provide for the citizens of the Albuquerque metropolitan area educational activities and information to promote bicycle and pedestrian ~~safety~~safety and hazard prevention, bicycling and walking as alternative transportation modes, and the health benefits of cycling and walking. The City’s Bicycle Safety Education Classes are a national model. This program is administrated by the Parks & Recreation Department.

A primary objective of the program is to increase the bicycle ~~safety~~safety and hazard prevention knowledge of Albuquerque Public School elementary Students (4th & 5th grade) through bicycle ~~safety~~safety education presentations and “bike rodeos.”

#### ***Bike Rodeos (Education)***

The City of Albuquerque offers 60 – 200 bicycle ~~safety hazard preventions~~safety education rodeos annually for elementary school students. Since 1996, the program has hosted over 15,000 bike rodeos. The program is aimed at grades 3, 4, and 5, and the program consists of a presentation for the whole grade level followed by individual classes practicing on a skills course. The Bike Rodeo combines a ~~safety-hazard and injury prevention~~ presentation with a hands-on bike-~~safety~~safety experience, in which the child rides through a simulated road on a bike. Helmets were distributed to children who participated in ~~bike safety hazard prevention programming the program~~. The program brings bikes and all supplies to schools or civic groups.

The League of American Bicyclists (LAB), a national organization, has developed an on-road training curriculum and a series of courses to teach bicycle handling and traffic skills (including Traffic Skills 101, Commuting, Cycling Skills for Kids and more). They certify trainers around the country who may offer these bicycle education sessions. The City offers Traffic Skills 101 classes quarterly. Website: [www.cabq.gov/recreation/bike](http://www.cabq.gov/recreation/bike).

#### ***Youth Bicycle Safety Program (Education)***

The City offers a free, year round bike ~~safety~~safety education clinic for youth ages 7-10 teaching children how to “drive” their bike ~~safely~~safely through a ~~safety-hazard and injury prevention~~ talk and a hands-on experience.

The City of Albuquerque Park and Recreation Department's Bicycling 101 is a comprehensive class for adults (children 12 or older considered with parents or guardians) certified by the League of American Bicyclists. An Advanced Mechanics Class is also available.

### **Defensive Driving Class (Education)**

The City requires City employees to take a defensive driving class in order to receive an operator's permit to drive a City vehicle. Half an hour of this class is taught by [the Bicycle Safety Education Program B&PSEP](#) with an emphasis on share the road principles. In 2013, an employee from the Parks and Recreation Department spoke at 11 classes, reaching approximately 451 city workers.

### **Other Ongoing Efforts in 2013 (Education, Outreach, Encouragement)**

- Two Bicycle Mechanics classes were offered serving eight (8) adults. The 7-hour class provides the participants with a solid background in bike mechanics.
- The BSE Program has performed four (4) Bicycle Commuting Essentials classes since January, with twenty five (25) participants.
- The Share the Road Program remains at four participating schools. The [Bicycle Safety Education Program B&PSEP](#) performed twenty nine (29) Share the Road presentations to five hundred fifty nine (559) young people studying to get their driver's license.
- The Bike Safety E-Newsletter has enjoyed a steady increase in subscribers, with two more issues released, and four hundred seventy eight (478) current subscribers.
- The "Pumped Up!" program, teaching middle and high school youth about flat repair and bicycle traffic [safety hazard and injury prevention](#), reached one hundred fifty two (152) participants.
- Two Cyclocross classes were performed, reaching eighteen (18) participants.
- The BSE Program answered thousands of calls per year relating to bicycling in the metro area, disseminated bike maps, and tracked all bike fatalities.
- The BSE Program purchased 6 new larger size BMX bikes for the bike safety rodeos. Painted bikes did not survive constant trailering. For years the program looked for chrome BMX bikes, and finally chrome has become an option.

It should be a top priority to continue, strengthen, and expand these programs. Seeking additional funding and staff capacity will be a key strategy, possibly through grant funding sources or local partners.

### **Esperanza Community Bike Shop Programs (Education, Encouragement, Outreach)**

The Esperanza Community Bike Shop opened its doors to the public on March 8, 2013 with the goal of promoting bicycles as a viable means of transportation and recreation in and around Albuquerque. The shop provides bicycle-related educational opportunities in a variety of media including informal and structured programs.

Esperanza is open to the general public for walk-in repairs. Shop patrons are guided through repairs for everything from flat tires to complete bicycle overhauls. Over the course of nine months, this has been the greatest forum for the shop to serve the general public. From March through October 2013, Esperanza was visited by a total of 1,376 people. This includes 736 youth under the age of 18, 497 adults age 18 and above, and 143 visitors who did not disclose their age. During this timeframe the shop was open three days per week in the Spring and Fall and four days per week during the summer months.

**Volunteers serve an important role at Esperanza.** Currently there are three categories of volunteers.

1. **Mechanical volunteers.** These individuals help complete repairs on bikes that belong to customers and contracted organizations as well as bikes being repaired at Esperanza for distribution through educational programming.
2. **Organizational volunteers.** These individuals help with the constant organizational and part sorting needs at Esperanza.
3. **Work-study students.** Esperanza partners with several local schools to provide students with work place experience in exchange for school credit. Work-study students enter the program with a variety of skill levels, but all receive formal training as part of the program. Increasing participation in the work-study program is an important goal because it provides long-term bicycle education, and once the volunteers are trained, they help Esperanza run more smoothly in its day-to-day operations.

The following text describes some of the services that Esperanza Community Bike Shop offers:

### ***League of American Bicyclists Certified Instructor Training***

In 2013, the Adult Bicycle Educator attended the League of American Bicyclists Certified Instructor Training in Atlanta, Ga. This is the only nationally recognized bicycle education program within the United States and is necessary to become a League Certified Instructor. Having this certification greatly increased the abilities of the Adult Education Program through classroom training and practical cycling insight. This training emphasized the teaching of [safe-best](#) cycling practices and road use law to adult cycling groups. The goal of this training is to help the instructor learn to foster an environment where participants feel confident about their ability to treat their bicycle as a vehicle and to ensure that people on bikes know how to ride [safely-with less risk](#) and legally. The training and certification received through this course was instrumental in planning several Esperanza Community Bike Shop programs.

### ***Albuquerque Metropolitan Court Safe Cycling Course***

The Esperanza Community Bike Shop's Adult Education Program is currently working with the Albuquerque Metropolitan Court to implement a "Share the Road" bike/motor vehicle education segment into the Aggressive Driver remedial training class that is currently run by the Metro Court. This course segment will cover the rights and responsibilities of both drivers and cyclists, in order to promote a level of understanding between all road users.

### ***Mom's Night Out Bicycle Maintenance Class***

In an effort to diversify the clientele of the Esperanza Community Bike Shop Adult Education Program, one Mom's Night Out Bicycle Maintenance Class has been held. Although attendance was low (4 participants and 2 volunteers), it is hoped that later classes will reach a wider audience. Through targeted classes such as this, the program aims to decrease the perception that cycling is predominantly male activity.

### ***Educational Materials***

The Esperanza Community Bike Shop's Adult Education Program has been working on several informational pamphlets to be distributed through the bike shop or at public events. These materials include an Esperanza Community Bike Shop brochure that explains the adult education opportunities available at the shop, a Bike Lock pamphlet that demonstrates proper use of bicycle locks and strategies



to avoid bicycle theft, and several bike maintenance pamphlets that highlight the key points in many repairs. Distribution of these materials is ongoing, and to date approximately 300 copies of bicycle theft prevention and flat tire repair pamphlets have been placed in the hands of community members. Through the use of these materials, the Esperanza Community Bike Shop's Adult Education Program is able to reach a larger audience to help promote safe and safer and more confident cycling.

### **Transit Bus Training Rack**

The Esperanza Community Bike Shop's Adult Education Program obtained a bike rack like the ones used on ABQ Ride busses. This rack has now been mounted on the wall of the Esperanza Community Bike Shop classroom to train cyclists on the proper loading of their bikes on ABQ Ride busses. This simple training decreases apprehension of multi-modal transportation and increases commuter confidence.

### **Guaranteed Ride Home Program (Encouragement)**

The City's transit provider, ABQ Ride, offers free guaranteed ride home service for residents who commute to work or school by bike, walking, carpooling, vanpooling, or transit at least three times a week. The service is offered within ABQ Ride's bus route service area.

### **Long-Term Parking Program**

The Bicycle Locker Program is intended to provide convenient locations for securely storing bicycles used for commuting to employment destinations, so that alternative modes of transportation can be locally supported and effectively promoted. Lockers are presently located close to various downtown government centers and adjacent to approximately thirty or more other public facilities and related private businesses scattered around the metropolitan Albuquerque area.

This federally-funded program has existed for many years. This program is administered by the City's Bicycle Coordinator within the Department of Municipal Development. The Bicycle Coordinator, which is a federally-funded position, manages new and existing written agreements submitted by individual bicycle commuters, who in exchange receive a locker key and agree to store only a bicycle within the locker at a prearranged location for a specific term. The Bicycle Coordinator reviews lockers on a periodic basis in order to minimize the potential for misuse.

The City currently manages around 300 bicycle lockers in locations requested by individuals and employers. Major employers that have taken advantage of the bike locker program include Intel, Honeywell, and the University of New Mexico. The purpose of this program is to provide secure bicycle parking to encourage bicycle commuting.

### **Bicycle Friendly Community Certification**

The League of American Bicyclist/Bicycle Friendly Community Program (BFC) provides incentives, hands-on assistance, and award recognition for communities that actively support bicycling. A Bicycle Friendly Community welcomes cyclists by providing safe welcoming promoting safe accommodation for cycling and encouraging people to bike for transportation and recreation. In 2005 the City of Albuquerque was recognized with the Bronze level award and is one of three cities in New Mexico recognized as a Bicycle Friendly Community (Santa Fe—Silver, Las Cruces—Bronze). The City maintains the Bronze standing as of 2014.

The Bikeway Coordinator is responsible for preparing and submitting application for this award along with community input and assistance from local advocacy groups. The application is an audit of the five E's: engineering, education, encouragement, enforcement, and evaluation efforts in the city. This comprehensive inquiry is designed to yield a holistic picture of the community's work to promote bicycling. The application also helps to identify areas that Albuquerque can improve upon, or begin collecting data to improve our standing in future years.

### **Environmental Education Program (Education)**

The Open Space Division of the Parks and Recreation Department provides Environmental Education and Interpretation through a number of outdoor activities, classroom programs and community events to educate the public on the use of Major Public Open Space and Trails. Trail maps are maintained for trail users and Hikes are sponsored as well as special events to heighten awareness of the low impact recreation and the protection of the natural state of Major Public Open Space. The Open Space Division's Trail Watch Volunteers Program is instrumental in educating the public about trail use ethics while noting maintenance needs to be corrected. In addition to hiking, mountain biking and horseback riding, the trails in the City's Parks, Open Space and Trails system provide the opportunity to protect and preserve the natural environment for the benefit of the Albuquerque resident and visitor trail users now and in the future. Each of these programs involves an element of outdoor stewardship education, including Leave no Trace Ethics, proper use of trails in MPOS, and in some cases, trail design and management.

### **Prescription Trails Program (Encouragement)**

The Prescription Trails Program provides prescriptions for walking and wheelchair rolling and a walking guide that suggests routes in our community targeting and promoting healthy lifestyles for individuals and families (& pets, too).

The City's Prescription Trail Program is intended to make information available to all residents about the importance of walking for health and how to get started in a self-directed or group program. The easy to use Guide provides information about specific parks in the Albuquerque area with maps organized alphabetically by zip codes and level of difficulty for each trail location, the length of each "loop" and what amenities are provided in each park facility. A walking log is included in the Guide so the trail user can easily document their distances walked. Information is also provided on Walking Clubs and Mall Walking for those rainy days.

## **2. Partnerships & Programs to Encourage and Support**

Local bicycling groups and state-sponsored programs offer a number of valuable materials and programs aimed at bicyclists and trail users. It is recommended that the following efforts continue to be provided to Albuquerque area residents. Where possible, these programs should be expanded in their scope to offer additional services and/or reach more residents.

### **Existing Committees, Organizations, Clubs, and Teams**

#### ***Greater Albuquerque Bicycle Advisory Committee (GABAC) and Greater Albuquerque **Regional Recreational** Trails Committee (GARTC)***

The City of Albuquerque has both a Bicycle Advisory Committee and a Regional Trails Committee that meet to address the needs of bicyclists and trail users in the Albuquerque area.

### ***Bike ABQ***

This non-profit bicycle advocacy group organizes bicycle education, encouragement, and enforcement programs for Albuquerque, in addition to advocating for infrastructure improvements. The organization hosts Bicycling 101 and Bicycle Mechanic classes, helps organize annual Bike to Work Day events and other bicycling events, and offers resources for bicyclists.

### ***Bicycle Coalition of New Mexico***

This statewide bicycling organization provides bicycle safety education classes, events, and other resources for bicyclists. Website: [www.bikenm.org/](http://www.bikenm.org/).

### ***Sandia Bike Commuters Group (SBCG)***

This bicycle commuter support group was formed in 1995 for employees of Sandia National Labs, a major area employer with about 8,500 employees, at KAFB. About 600 employees are on the mailing list for the SBCG, by which they receive event updates and other supportive communications. Members can also add content to the group's website, which contains many resources for bicyclists such as information on safety, gear, and facilities. The group estimates that about 200 employees commute by bicycle regularly. The group also hosts a Bike to Work Day event annually and offers a Bike Buddy program for employees.

### ***Duke City Wheelmen Foundation***

This local racing team hosts memorial rides and bicycle rides to highlight bicyclist visibility. Website: [www.dukecitywheelmen.org/](http://www.dukecitywheelmen.org/).

### ***New Mexico Touring Society***

The New Mexico Touring Society (NMTS) is a recreational bicycling club. The group holds numerous weekly rides and helps organize local bicycling programs, such as Bike to Work Day and valet bike parking at local events. The NMTS website also offers resources and information for existing and potential bicyclists. Website: [www.nmts.org/](http://www.nmts.org/).

### ***Women's Mountain Bike and Tea Society (WOMBATS), New Mexico Chapter***

WOMBATS is a women's mountain biking group in New Mexico. The group offers rides, classes, and other mountain biking activities and resources specifically for women.

### **MRCOG's Job Access Reverse Commute Program (Education)**

The Mid-Region Council of Governments Job Access Reverse Commute (JARC) program provides many transportation benefits to lower income working individuals within the local area. Esperanza Community Bike Shop's Adult Education program has partnered with the MRCOG to provide safe cycling training and a refurbished bicycle to interested individuals within the JARC program.

A trial run of the JARC Bike Safety class was held on October 29th, 2013, with 5 MRCOG representatives and 2 Parks and Recreation personnel in attendance. The City and MRCOG are finalizing a Memorandum of Understanding and expect to be running a full schedule of JARC Bike Safety classes shortly.

### **Safe Routes to School (Evaluation, Engineering, Education, Encouragement, Enforcement)**

Expanding the existing New Mexico Safe Routes to School program will offer great benefits to children's health and safety. The statewide Safe Routes to School program, run by the NMDOT, offers funding



assistance for developing an action plan, implementing infrastructure projects, and offering non-infrastructure projects.

It should be noted that funding for this program is currently on hold pending Congressional reauthorization of the federal transportation bill. The City should track availability of statewide funding and consider it a priority to apply for funding when the application process is re-opened. The City could also connect with APS for more general outreach and promotion to get students and teachers interested and educated about bicycling.

### **“Share the Road” Public Service Announcements (Education)**

This BikeABQ campaign increased awareness through eight public service announcements that were broadcast on local television in 2009. The videos are currently available on YouTube. Website: [www.youtube.com/user/bikeabq](http://www.youtube.com/user/bikeabq).

A local advocate, Olev Rapido, also coordinated a Share the Road campaign by distributing bumper stickers with bicycle friendly messages. The stickers feature messages such as “Share the Road” and “5 Feet to Pass: It’s the Law.” Bumper stickers have been made available at area bicycle shops, sports stores, and Whole Foods Market. Website: [www.bicyclenm.net/OlevRapido/AwarenessInitiative/index.html](http://www.bicyclenm.net/OlevRapido/AwarenessInitiative/index.html).

### **Valet Bike Parking (Encouragement)**

Recently the City has experimented with Valet Bicycle Parking during special events that attract people traveling to the event by bicycle. For example, at the 2009 Albuquerque International Balloon Fiesta approximately 200 secure bicycle parking spaces were available. The valet parking area was conveniently located next to a multi-use trail that connects the North Diversion Trail to the nearby balloon launching fields. At peak use times the parking area was at full capacity.

Valet bike parking is offered at the Balloon Fiesta and Freedom Fourth as a joint effort of the New Mexico Touring Society, BikeABQ, the City, and the event organizers.

Adult education at Esperanza Community Bike Shop came into full swing with the 2013 City of Albuquerque’s Freedom Fourth Celebration at Balloon Fiesta Park. The bike valet parking was provided at the July 4th event to promote cycling within the City and to help with traffic and parking congestion. Over the course of the event, 278 bicycles were [safely-securely](#) stored for the public, including several tandems, child trailers, and child seats. This shows an interest in bicycle transportation among families and demonstrates the feasibility of bicycling with young children.

Assuming that the people attending the event were averaging 2 individuals per



car, the Bike Valet at the Freedom Fourth removed 139 cars from the traffic flow around Balloon Fiesta Park and greatly decreased traffic and parking congestion. The turnout and use of the Bike Valet greatly exceeded expectations for this event, showing the potential for the growth of transportation and utility cycling within the City of Albuquerque.

Due to the volume of positive public feedback received concerning the Freedom Fourth Bike Valet, the City continued to provide bike valet services at City events throughout the summer. Bike valet parking was offered at the City of Albuquerque's Summerfest street parties, where use of the service ranged from 21 bicycles to 78 bicycles per event. The social atmosphere at these events also fostered conversations between staff, bike valet volunteers, and the public about [safe-better cycling practices](#) and [to-distribute allowed for the distribution of](#) educational materials. Staff at these events also distributed bicycle lights to cyclists without proper bicycle lighting; this was very well-received by the public and reinforced the City's goal of increasing the number of responsible cyclists on our roads.

Listed below are the public use numbers of the bike valet parking offered at events in 2013:

- Freedom Fourth – 278 Bicycles (139 cars off of the road)
- Nob Hill Summerfest – 78 Bicycles (39 cars off of the road)
- Downtown Summerfest – 64 Bicycles (32 cars off of the road)
- Westside Summerfest – 26 Bicycles (13 cars off of the road)
- Old Town Salsa Fiesta – 21 Bicycles (10 cars off of the road)
- Montessori on the Rio Grande Harvest Fest – 23 Bicycles (11 cars off of the road)

Through the Bicycle Education Grant, mobile bicycle racks, banners, and shade tents have been purchased to improve the overall level of service for patrons bike valet within the Albuquerque Metropolitan area. This service continues to promote the use of the bicycle as a viable transportation option. The City and partners should continue this popular service at public events.

### **Bike-to-Work Day (Outreach)**

Local bicycling groups, with the support of the City of Albuquerque, host Bike-to-Work Day annually. The 2014 event featured ten commuter stations near major employment areas with breakfast, giveaways such as water bottles and patch kits, prize raffles and other giveaways.

The City and other event partners (such as BikeABQ) should continue to support the event at the same level, and if possible expand the event to include components such as such as a commute ride to or from City Hall with the Mayor/City Council, commute classes, bike commute challenge contests, and celebratory events.





### **Driver Education (Education)**

Three independent driving schools have signed up for the City's Share the Road presentations. This presentation lasts approximately one hour and teaches new motorists their responsibilities toward cyclists. It also teaches the new motorists the rights and responsibilities for cyclists. The interactions and questions from the new drivers have been priceless.

### **Albuquerque Community Bike Recycling Program (Encouragement)**

This local non-profit volunteer group recycles bicycles by accepting donated parts and bicycles, rebuilding them into working bicycles, and donating those bikes to children and adults in need in Albuquerque. The group also hosts bicycle safety and repair demonstrations to public schools and adult groups. Website: [www.communitybikerecycling.org/](http://www.communitybikerecycling.org/).

### **2010 National and New Mexico Bicycle Rally (Encouragement)**

This national event was held in Albuquerque on June 3 - 6, 2010 and featured classes, rides, guest speakers, and a film. The national event kicked off the first state bike rally in New Mexico. The Bike Coalition of New Mexico plans to hold annual state bike rallies in the future.

### **University of New Mexico Bicycle Programs (Encouragement)**

The University of New Mexico offers many services for bicyclists on campus, including students, faculty, and staff. The campus features many racks and 50 bike lockers, as well as a bike shop, which offers bicycle repair, maintenance, and rental bikes for recreation. Campus-suggested bike route maps are published as part of parking and transportation information, and maps of bicycle racks and lockers are available online.

The Parking and Transportation Services Department also offers a bike sharing program to campus departments. Ten bikes are loaned out to 10 departments on an annual basis for work- or university-related use. In addition to the bike, the department receives appropriate gear and bicycle safety education and agrees to store the bike indoors.

In addition to a campus bike parking map, the University's bicycle program website offers free bike registration, a guide to bicycle security, bicycling safety and maintenance tips, and links to other resources. Website:

[www.pats.unm.edu/bike\\_it.cfm](http://www.pats.unm.edu/bike_it.cfm).

### **Group Rides (Encouragement)**

Various bicycling groups in Albuquerque host group road and trail rides, such as Farmers Market tours and the Ride of Silence to honor bicyclists killed and injured in crashes, charity rides, etc. The BikeABQ blog promotes these community rides.

### **Bicycle Events (Encouragement)**

Throughout the year, numerous bicycling events are held. These include races, skills competitions, and bike polo







events. These events are tracked through some community calendars, such as [www.nmcycling.org](http://www.nmcycling.org), [www.usacycling.org](http://www.usacycling.org), and [www.bikehubnm.com](http://www.bikehubnm.com). Facebook pages have been created to promote these events, such as the Critical Mass Albuquerque and Duke City Classic pages.

### **Ghost Bike Memorials (Education)**

“Ghost bikes” are roadside memorials that commemorate the location a cyclist was killed. They are bicycles painted white, typically decorated with flowers and other personal items or notes

to recognize the individual. Some argue that these installations fall under the 2007 State law that outlaws the desecration of roadside memorials, or *descansos*.

## **B. New Programs to Expand or Initiate**

It must be stressed here that as of 2014, the City does not have the resources to expand upon the current offering of programs and projects that are currently ongoing. However, in the future, additional funding or staff resources may be allocated to develop some of the recommended programs below. Additionally, some of these programs could be initiated by community-based groups with targeted City support.

### **Launch Parties for New Bikeways and Trails (Promotion)**

The recommendation to host Launch Parties for New Bikeways should be implemented in coordination with bikeway implementation projects. It is a low-cost strategy that publicizes new facilities and builds public awareness of bicycling. As a low-cost/high-benefit program, it should become part of the City’s standard bikeway implementation procedure.

### **Coordinate Enforcement Actions (Education & Enforcement)**

Enforcement actions can include motor vehicle speed enforcement, speed reader board deployment, bicycle light enforcement, trail crossing enforcement, and other actions.

Speeding vehicles endanger cyclists and discourage cycling. Targeted speed enforcement activities can address both of these issues. Law enforcement agencies can enforce speed limits on designated bikeways, near schools, and in response to bicyclist complaints. These campaigns are ideal for a Safe Routes to School Program. A speed reader board request program will deploy speed reader boards at the request of neighborhood associations and schools. The boards should be mounted temporarily (e.g. for two weeks) and then be moved to another location to keep motorists from becoming inured to the speed reader board effect.

A bike light enforcement program can issue “fix-it” tickets or warnings to bicyclists without lights and distribute safety brochures. The actual installation of free lights on the spot is a common alternative where everybody wins. The City should continue and consider expanding its bike light giveaway program.

### **[The 2012 League of American Bicyclists \(LAB\) Report for](#)**



Albuquerque listed this as a key measure to take to improve cycling: “Ask police officers to target both motorist and cyclist infractions to ensure that laws are being followed by all road users. There seems to be a particular problem with enforcing the law that prohibits parking in bike lanes and drunk driving. Ensure that bicycle/car crashes are investigated thoroughly and that citations are given fairly.”

For enforcement, all efforts will need to be coordinated with the Albuquerque Police Department (APD). The City should enter into discussions with the APD and seek to jointly agree to proceed with Law Enforcement Education trainings and Community Enforcement Actions (such as targeted speed enforcement near schools, speed reader board deployment, bicycle light giveaways, etc.). Several APD officers have already worked with GABAC and the City on bicycle and trails enforcement issues, so it is suggested that the City initiate contact through these officers.

### **Launch a Unified Share the Road Campaign (Awareness)**

A marketing campaign that highlights bicyclists’ [safety-right to coexist in the roadway](#) is an important part of creating awareness of bicycling. This type of campaign is an effective way to reach the general public and reinforce other education and outreach messages. The City should create a unified [safety bicycle awareness](#) campaign building on existing work by BikeABQ and the BSE Program, placing [safety bicycle awareness](#) messages near high-traffic corridors (e.g., on billboards, in bus shelters, and in print publications).

A well-produced [safety-share the road](#) campaign can be memorable and effective. One stellar example is the Sonoma County Transit “You’ve got a friend who bikes!” campaign. It combines compelling ads with an easy to- use website focused at motorists and bicyclists. This type of campaign is particularly effective when kicked off in conjunction with Bike to Work Day in May or back to school in the fall.

A media partner should be identified who could donate ad space/time and a steering committee formed to develop messages and a campaign strategy. A professional graphic design and/or marketing firm would elevate the effectiveness of the campaign.

### **Launch a Share the Trail Campaign (Awareness)**

Conflicts between trail users can be a major issue on popular, well-used trail systems like the Bosque Trail. Some communities have launched successful “share the trail” events to help educate users about [safety-and-safety and trail](#) courtesy. Share the Trail campaigns can be run by agencies, nonprofits, or any user group (equestrian, hikers, etc.). These programs educate users about expected behavior and how to limit conflicts. Volunteers often give out brochures and engage with users in a non-confrontational way. Volunteers can also report back to trail agencies about trail damage, erosion, or vandalism. Media outreach should be included as well. Common strategies include a bicycle bell giveaway, handing out maps and information, posting signs, tabling, and ‘stings’ that reward good behavior.

### **Apply to Become a Silver-Level Bicycle Friendly Community (Promotion)**

The League of American Bicyclist/Bicycle Friendly Community Program (BFC) provides incentives, hands-on assistance and awards recognizing communities that actively support bicycling. A Bicycle Friendly Community welcomes cyclists by [providing-promoting safe a proactive-safer](#) accommodation for cycling and encouraging people to bike for transportation and recreation.

The City’s Engineering Group should prepare and submit an application for this award, with community input and assistance from local advocacy groups. The application is an audit of the five E’s: Engineering,

education, encouragement, enforcement, and evaluation efforts in the City. The City should work with local advocacy groups to improve its application in the hopes of being awarded the silver level recognition. There are two application deadlines per year: one in February and the other in July.



### **Family-Oriented Bicycling and Trail Use Programs (Promotion, Outreach)**

Family bicycling/trail programs help parents figure out how to [safely](#) transport children by bicycle and help children learn bicycling skills. The format can vary. Some events are panel discussions or workshops; others are open-house style events (e.g. at a park or on a trail) or activities at larger local events, such as the New Mexico State Fair.

#### **Family activities may include:**

- **Training** for children on how to ride a bicycle without training wheels
- **Bicycle skills/[safety](#) course** for children (e.g. rodeo)
- **Information** about options to transport children (e.g. trailers, cargo bicycles, child seats, family tandems) and the opportunity to test ride these devices
- **Group ride or parade** (possibly with bicycle decorating station)
- **Bicycle safety check** ([ABC's – air, breaks, chain/cranks operation check](#))
- Basic bike **maintenance course**
- Distribution of bicycling **maps & brochures**

Several family-oriented outreach programs are recommended, including a Summer Streets Car-Free Street Event, a Bike to Parks Program, and a Mountain Biking Program. These all should be seen as medium-priority actions and the City should select a program to focus on first. A *Share the Trail Campaign* is not a first-tier priority but may be implemented sooner if a community group like BikeABQ were willing to take primary responsibility for it.

#### **Summer Car-Free Street Events (Encouragement)**

These programs have many names: Summer Streets, Sunday Parkways, Ciclovias, or Sunday Streets. Summer Streets are periodic street closures (usually on Sundays) that create a temporary park that is open to the public for walking, bicycling, dancing, hula hooping, roller skating, etc. They have been very successful internationally and are rapidly becoming popular in the United States. They promote health by creating [a safe and and](#) attractive space for physical activity and social contact and are cost-effective compared to building new parks for the same purpose. These can be weekly or onetime events and are generally very popular and well-attended. Summer Streets events also often included guided rides and walks with themes, such as walks for seniors, women's or family rides, or bike rides with the Mayor/City Council.

[In September of 2014, the first "ABQ CiQlovía" event was held. The event was generated largely through volunteer efforts, which led to support by MRCOG, City Council, and a variety of other local organizations. It was a hugely successful event that was strategically combined with the existing Carnuel](#)



Road Parade and Fiesta. Together, the parade and ABQ CiQlovía attracted over 4,700 people who walked, biked, and played in the streets of downtown Albuquerque. ABQ CiQlovía integrated a demonstration buffered bicycle lane, and a demonstration of intersection improvements was chalked at the crossing of the 14th Street Bike Boulevard and Lomas Blvd. The City should strive to support and encourage future CiQlovía events.

### ***Bike to Parks Program (Promotion)***

Encouraging bicycling on trails and to parks is a great way to increase community health, decrease motor vehicle congestion and parking issues at parks, and maximize the use of public resources. A “bike to parks” program could distribute information about how and why to bike to parks. Elements may include:

- Distributing route information through maps, brochures, and online outreach
- Guided rides on trails and to parks
- Information kiosks
- Improved bicycle parking at trailheads and parks
- Outreach to existing groups (e.g., BikeABQ, senior and youth groups, schools/SRTS, etc.)

### ***Mountain Biking Program (Encouragement)***

A program to encourage mountain biking for adults and/or children can include safety-hazard identification and avoidance education, skills training, group rides, and events. For example, the program can host introductory clinics to teach mountain biking skills and techniques.

Temporary riding courses can be set up at events, such as a Summer Streets car-free event, or a permanent course can be built. Class-based courses could also be offered. The Share the Trail program in Marin County, CA hosts workshops and group rides and provides safety and way-finding information to mountain bikers.



### ***Provide Driver Education Related to Bicycling (Education)***

Improving driver awareness of bicyclists helps to make a safer and more comfortable and less hazardous road environment for bicycling. Outreach through Drivers Ed classes is a good way to reach beginning drivers, while a diversion class can be offered to first-time offender violations that endanger bicyclists.

A Driver Diversion Class can be aimed at motorists and bicyclists. In lieu of a citation and/or fine, individuals can take a one-time, free or inexpensive class. In Marin County, interested citizens can take the class even if they did not receive a ticket. This program is a good way to educate road users about bicycle rights and responsibilities, and it can also increase public acceptance of enforcement actions.

Developing a Driver Diversion Class will be a longer-term effort, as it will require coordination with many community partners. The Diversion Class will require the support and participation of local courts, and working with lawyers, traffic safety-professionals and educators to prepare the curriculum will help the program launch on a firm footing. This program may need start-up funding to develop the

course, but it should be self-sustaining on a long-term basis as the fee for participation can be set to cover the costs of the program.

### **Perform Annual Bicycle and Trail Counts ([Evaluation & Data Collection](#))**

Many jurisdictions, including the City of Albuquerque, do not perform regular bicycle or trail counts. As a result, they do not have a mechanism for tracking bicycle or trail use trends over time, or for evaluating the impact of projects, policies, and programs.

The City should conduct and/or coordinate annual counts of bicyclists and trail users according to national practices. The National Bicycle and Pedestrian Documentation Project has developed a recommended methodology, survey, count, and reporting form, and this approach may be modified to serve the needs and interests of individual jurisdictions.

The City should take the lead in standardizing a regional approach to counts and surveys. City staff may perform the counts themselves or assist local groups or volunteers in conducting the counts. The City of Albuquerque should also handle tracking, analysis, and reporting. The *Bikeways & Trails Facility Plan* established baseline counts at approximately 40 locations for morning and afternoon peak times. The locations of these initial counts should be considered for annual counts, see **Appendix D.1**.

[Additionally, Bernalillo County and MRCOG have recently installed trail counter locations at 7 and 13 locations, respectively. These permanent counters should be used to gather user count data on an on-going basis. The City should coordinate with these agencies to use these data.](#)

### **Bicycle Rack Program (Promotion)**

The City should develop and implement a Bicycle Rack Program, which, similar to the Bicycle Locker Program, distributes racks across the city by request. By working with interested land owners to supplement the existing supply of bicycle parking, the City would effectively increase both the quantity and quality of bicycle parking throughout Albuquerque. The City can use preferred rack designs and ensure proper rack placement and the different types of bicycle racks - as rack types vary in their functionality - following the bike parking guidelines laid out in existing code or in **Chapter 7, Design Manual**. The program should provide assistance in the location, design and funding of bicycle racks to stimulate retrofitting short-term bicycle parking in the existing system.



This program should prioritize placement of enhanced bicycle facilities at key transit exchanges, such as the Alvarado Transit Center, if demand analysis indicates adequate potential for facility use.

### **Promote Increased Awareness of End-of-Trip Facilities (Promotion)**

The City could raise awareness of the benefits of short- and long-term bicycle parking and end-of-trip facilities to developers, owners and managers of privately-owned commercial properties. The 2010 report, *Bike Corrals: Local Business Impacts, Benefits and Attitudes*, found widespread support for bike corrals from local businesses. "The Employer Guide to Bicycle Commuting: Establishing a Bike-Friendly Workplace for your Baltimore Region Employees" is a good example of information that the City could

make available to employers interested in encouraging cycling to work. The document compares the initial cost of 12 automobile parking spaces (\$40,000 to \$100,000) to the cost of 12 bike rack spaces and one automobile space (\$4,600 to \$9,600). This program should also provide guidance on the design and placement of these facilities.

### **Provide Incentives for End-of-Trip Facilities (Encouragement)**

A number of incentives can be used to **encourage improved bicycle parking** and end-of-trip facilities. These include:

- Relax motor vehicle parking requirements where bicycle parking is provided beyond the minimum requirements.
- Relax motor vehicle parking requirements where complete end-of-trip facilities are provided (i.e., long- and short-term parking coupled with showers, washrooms, and clothing lockers).
- In space-constrained applications, such as the redevelopment of an existing building, allow for the conversion of motor vehicle parking spaces into long-term bicycle parking to meet the bylaw requirement (typically five bicycle parking spaces can be achieved per motor vehicle parking space).
- Extending or introducing payment-in-lieu-of-parking programs to allow funds to be collected in-lieu of vehicle parking and placed in a sustainable transportation infrastructure fund to finance active transportation projects, which may include a centralized bicycle parking and end-of-trip facility (e.g., a bike station). Note: This should not replace bicycle parking and end-of-trip facility requirements.

### **Bike Share Programs**

A bicycle sharing system is a service in which bicycles are rented to individuals at unattended stations using electronic vending on a short term basis. Bike share schemes allow people to make short distance trips by borrowing a bike at a kiosk in one location and returning it to a kiosk in another location. A proposed system for Albuquerque would first be implemented in higher density, pedestrian-oriented areas with large employment and tourist bases such as Old Town, Downtown, UNM, and Nob Hill. Each kiosk would provide approximately 12 bikes. Approximately 25 kiosk stations would be installed at the onset. Alternately, there are bike share programs that rely on 'smart bikes' instead of kiosk systems. The City, County, and UNM would fund the capital costs to install the first kiosks or smart bike infrastructure. The program could be operated by either local government or non-profit groups, which would be responsible for maintaining the kiosks using revenue collected at them. The bike share system may be expanded over time to other areas of the city by public and private entities as demand intensifies.

### **Other Trends in Bicycle & Trail Planning**

The City Bicycle and Trail Coordinator(s) should stay abreast of current trends and the state of the practice for encouraging and promoting bicycle and trail use. Some of the current concepts that could be considered include:

- ~~Bike Share Programs~~
- Bicycle Friendly Business Districts and other zone code amendments to support bicycle culture
- Explore regulation of electric cycles and electric assistance cycles. Electric bikes and trikes may become increasingly important for our aging citizen who may need this capability to continue to



enjoy cycling. They also provide a transportation capability for citizen who can no longer drive a motor vehicle.

- Explore development of a water trail in the Albuquerque reach of the Rio Grande and where feasible and considering public security develop/redevelop public infrastructure to support it. There are many groups nationally pursuing this type of initiative. Adoption of such a project can release state boat safety money and federal scenic river money and it is consistent with the Bosque Action Plan.
- Smart Trips - This is a program that targets neighborhoods to encourage people to walk, bicycle and take the bus. It also involves assessment of the impact of this intervention.  
<https://www.portlandoregon.gov/transportation/43801>

As staff time, funding, and local priorities dictate, the bicycle and trail coordinator(s) should consider the local applications of these national trends.

# **CHAPTER 6: IMPLEMENTATION STRATEGIES**

Achieving the goals of the *Bikeways & Trails Facility Plan* requires the coordination of staff time with available funding and public input. While the City of Albuquerque can directly implement infrastructure investments, implementation of education, outreach, enforcement, and evaluation programs will necessarily involve numerous community partners.

This implementation plan is an important component of the overall planning effort. It helps ensure a structured approach to project development that involves the bicycling community, the general public, elected officials, city staff, partner organizations, and funding agencies. Additionally, the implementation plan serves as a measure of Albuquerque's progress on achieving these goals through the completion of particular projects, education, encouragement, and measurement with each passing year. As a result, implementation should be seen as an ongoing process rather than a finite task. This chapter provides guidance on strategies to implement recommended projects and programs.

## **A. Bikeway & Trail Facility Development Approach**

### **1. Administrative Organization & Coordination**

This plan seeks to create linkages between the Planning Department, Parks & Recreation (P&R) and the Department of Municipal Development (DMD) regarding planning of future projects and programming funding for facility improvements and projects. This will happen by communication and coordination about the design of trails and on-street bikeways. Bikeway and trails activities will also need to be coordinated with other agencies. The interdepartmental and cross-agency coordination would ideally take place at key milestones during the planning, design, and implementation of projects and programs.

#### **Ideally coordination would take place to:**

- Coordinate funding requests
- Annually update the Map and proposed projects list
- Adhere to Design Guidelines
- Train the Technical Review Committee
- Organize trainings
- Conduct interagency meeting and bikeways issues
- Update this Plan (at ~~5~~10~~4~~ year intervals)

One of the issues for the bicycle and trail network in Albuquerque is that responsibilities for the system are divided among various departments, primarily P&R and DMD, but also the Planning Department, City Council and Cultural Services, requiring significant and on-going coordination and cooperation. Other communities have the same dynamic.

The Planning Team performed a comparative review of other jurisdictions' administrative organization and operations for their bicycle and trails programs. Looking to other successful communities can inform future organizational and/or operational restructuring in Albuquerque. The main finding of this review is that all of the communities surveyed also spread the responsibility for planning, design, construction, and maintenance among Public Works, Parks & Recreation, County Public Works and/or Parks & Recreation, and Regional Council of Governments. Our current organization of responsibilities is

generally consistent with other communities. These findings support this Plan's recommendations to focus on consistent and ongoing coordination among all the key departments and agencies who engage in bikeways and trails work.

A final thing to note is that both Minneapolis and Nashville/Davidson County have regionally focused boards or commissions within their Parks & Recreation Departments that address the recreational and experiential component of trails, along with other park and recreational topics.

## **Administrative Policies, Objectives, and Strategies**

~~Following are proposed policies, objectives, and strategies to outline how City Departments can work together more efficiently for the benefit of trail users and cyclists. They provide an approach to implement Goal 7 of the *Bikeways & Trails Facility Plan*.~~

### ~~**Streamline administrative practices and coordination (Goal 7):**~~

- ~~1. **Policy:** Organize and coordinate implementation of this Plan among City Departments and other agencies to produce well-designed facilities and a connected network of trails and bikeways that are safe, comfortable and enjoyable for the public to use.~~

~~This section outlines a more specific approach to implement the *Bikeways & Trails Facility Plan Goal 7, Streamline administrative practices and coordination, and specifically Policy 7.c: "Organize and coordinate implementation of this Plan among City Departments and other agencies to produce well-designed facilities and a connected network of trails and bikeways that are comfortable and enjoyable for the public to use."*~~

**Objective 1:** Provide full-time staff positions dedicated to trails and bikeways with appropriate office budgets to promote bicycling and trail use within Albuquerque.

**Objective 2 (Planning):** Create linkages between Planning Department, Parks & Recreation, and DMD regarding planning of future projects and programming funding for facility improvements and projects.

- ~~1. **Strategy:** DMD and Parks & Recreation, with assistance from the Planning Department, will coordinate requests for trails and bikeways funding. DMD will assist Planning and Parks & Recreation in the federal application process, and the three departments will coordinate representation at MRCOG.~~
- ~~2. **Strategy:** The Planning Department, in coordination with DMD and Parks & Recreation, will take the lead on developing funding mechanisms and implementing the 50-Mile Activity Loop.~~
- ~~3. **Strategy:** DMD and P&R, with assistance from the Planning Department will maintain an accurate list of major bikeway and trail projects currently programmed, to be updated on a biannual basis reflecting the status of programming, funding, design, and construction. This list will be the basis of the discussion and outcome of the two preceding strategies.~~
- ~~4. **Strategy:** DMD and Parks & Recreation, with assistance from the Planning Department, will conduct an annual update of the existing and proposed facilities map.~~

**Objective 3 (Design):** Foster linkages among critical departments within the City (primarily Parks & Recreation, DMD, and Planning) to communicate and coordinate activities related to design of trails and on-street bikeways.

- ~~1. **Strategy:** Adhere to the Design Guidelines adopted as part of this Plan when implementing projects unless strict adherence is not feasible. Any deviation must be documented by the project manager, including a rationale for the deviation.~~



2. **Strategy:** Create a Technical Review Staff Coordination Committee (TRCSCC) to include a few key staff members (P&R, DMD, and Planning Department) with expertise in design of trail and bike facilities. TRCSCC would review major projects on a project-by-project basis, and will be particularly focused on the project scoping and pre-design phases. This review would be in addition to and in anticipation of the Design Review Committee (DRC), which reviews and approves construction plans to ensure compliance with the Design Standards. Other experts would be included on a case-by case basis as necessary, e.g., ADA specialist, Traffic Engineer, Park Management, AMAFCA, etc. Where there are potentially difficult design issues, a pre-design meeting of the TRCSCC would be appropriate and input from Citizen Advisory Groups will be sought. TRCSCC's recommendations will be documented by the Project Manager.
3. **Strategy:** Parks & Recreation and DMD will jointly organize periodic trainings for personnel, rotating among topic areas. Trainings will be kept to a manageable size but provide space for representation from citizen advisory groups. Coordination with MRCOG regarding topic areas is essential. Potential topics include:
  - a. Multi-use trail design issues and innovations: for engineers, landscape architects, and others involved in trail design, including both in-house and non-City professionals.
  - b. On-street bikeway design, including intersections, and techniques for trail crossings of arterials: for traffic safety personnel, engineers, and others involved in bikeway design.
  - c. Maintenance practices, issues and techniques: maintenance staff.

**Objective 4:** Coordinate bikeway and trails activities with other agencies.

4. **Strategy:** DMD and Parks & Recreation (with assistance from Planning Department) will conduct a biennial (every 2 years) meeting among agencies involved in planning and implementation issues regarding bikeways and trails (construction, right of way, maintenance, funding, education, etc.) to include at least: the City (DMD, P&R, Planning Department, Open Space Division, Park Management, Bike Safety Program) NMDOT, Bernalillo County, AMAFCA, MRCOG, MRGCD, Rio Rancho, and representatives of Citizens Advisory Groups and other advocacy groups. Topics will include: presentation of status reports regarding funding and programming, new facilities, new standards, and how to resolve recurring issues. A summary of the meeting and outcomes will be transmitted to participants and the Mayor and City Council and be posted on the City's website.
5. **Strategy:** DMD and Parks & Recreation in partnership with the Planning Department will update this Plan every 10 years 4 years.

**Objective 5:** The City (DMD, Parks & Recreation, and Planning) will utilize the input of Citizen Advisory Groups in an effective manner.

## 2. Bicycle & Trail Coordinator

Albuquerque currently has **full-time Trail Planner Coordinator** and a **grant-funded Bicycle Encouragement Planner Coordinator positions**. There are also a number of Community Recreation Coordinators in Parks & Recreation whose work includes bicycle education programs. The 1993 *Trails & Bikeways Facility Plan* recommended both Bicycle/Pedestrian Coordinator and Trail Coordinator positions to take on the major responsibilities of implementing the elements with the plan. Likewise, the work plan of these staff should be aligned with the Implementation Plan in order to coordinate current bicycle and trail planning efforts and to assist with implementation of the many projects and programs recommended in this Plan. **The work should be divided between the Municipal Development and**

## Parks & Recreation departments, bridging the gap between bicycling and trail use as transportation and as recreation.

In addition to existing bicycle ~~safety~~ education activities, **job duties for these staff positions may include:**

- Monitor the design and construction of bikeways and trails, including those constructed in conjunction with private development projects.
- Ensure bicycle facilities identified in specific plans are designed appropriately and constructed expeditiously.
- Staff GABAC and GARTC meetings.
- Continue the implementation of existing programs and projects.
- Coordinate implementation of the recommended projects and programs listed in this Plan.
- Identify new projects and programs that would improve the City's environment for bicycling.
- Collect data and monitor trends in bicycle & trail use in the City.
- Coordinate evaluation of projects and programs.
- Pursue funding sources for project and program implementation.

### 3. Role & Structure of Advisory Committees

Albuquerque has two advisory committees related to bicycle and trails issues. Both are created by ordinance: the Greater Albuquerque Bicycling Advisory Committee (GABAC), and the Greater Albuquerque Recreational Trails Committee (GARTC). The two-committee structure allows multiple perspectives regarding the trail system. City Parks & Recreation (P&R) staffs GARTC and the Department of Municipal Development (DMD) staffs GABAC. The purpose of this section is to consider new ideas on how to structure Albuquerque's advisory committees related to bicycle and trails programs, planning, and implementation.

#### Issues

~~Several members in leadership positions in the committees have described Albuquerque's two-committee structure as flawed. Committee members have expressed dissatisfaction with Albuquerque's two-committee structure. Some of their criticisms include: P&R doesn't attend GABAC; DMD doesn't attend GARTC; and GARTC doesn't have bicycle riders officially represented. Members are frustrated and ask: "What is our function? Our comments are too late in the process to be useful." Staff considers the two-committee structure duplicative and recommendations from each group are sometimes conflicting. Staffing both committees is very time-consuming. Also, City staff reports that both committees are very dissatisfied and that it is hard to fill positions, for a variety of possible reasons. The point of contact with other agencies and jurisdictions is unclear and varied (sometimes through GABAC/DMD; sometimes through GARTC/P&R).~~

~~Comments from the public included these: The committees aren't listened to, there is no structure, "catch as catch can" on whether they are able to provide input at the correct point in the process; there is minimal website presence for the committees; APD, NMDOT, and other agencies need to come to GABAC; and GARTC needs to be able to provide input on design. Another major challenge both advisory groups mention frequently in their meetings is the application of the **Open Meetings Act** to their work. The requirement to conduct business and discussions in publicly advertised, open meetings~~

~~makes it challenging to accomplish work between monthly meetings. GARTC has created subcommittees to study certain issues in more detail, and then report back to the entire committee.~~

~~The Working Group reviewed the issues and draft concepts related to the structure of the committees with GABAC and GARTC in May and June, 2014. Those concepts are described below. Although there is a general sense that the current two-committee structure is not working very well, both committees agreed the issue needs more thought. There is generally a sense that one combined committee bringing together citizens, staff and guest presenters might be more efficient, but there are concerns that the voices of pedestrians, ADA advocates and equestrian issues might be overwhelmed and left out of the discussion. There is broad support for reaching out to Bernalillo County to join a combined committee since the trails and bikeways system is a regional network. Following is an overview of how other communities address citizen advisory groups. Committee members have expressed frustration with Albuquerque's two-committee structure. Some of their criticisms include: P&R doesn't attend GABAC and DMD doesn't attend GARTC. GARTC doesn't include representation of the broad cycling community and GABAC is not representative of the wide range of cyclists' types, abilities and confidence levels. Responsibilities between the Committees are unclear and they believe their comments on projects are too late in the process to be useful. Staff considers the two-committee structure duplicative (the same presentations have to go to two committees) and that the committees are very time-consuming given their departmental ~~resouces~~resources. Also, City staff reports that both committees are dissatisfied and that it is hard to fill positions, possibly for a variety of reasons. The point of contact with other agencies and jurisdictions is unclear and varied (sometimes through GABAC/DMD; sometimes through GARTC/P&R).~~

### **GABAC/GARTC/Public Input**

~~Several alternatives (status quo, a Bicycle Pedestrian Advisory Committee, and a City/County or Regional combined advisory committee) were presented for feedback from GABAC and GARTC and shared at public meetings on the BTFP in July 2014. These are some of the major themes that were voiced:~~

- ~~1. Many committee members understand the advantages of consolidating into one committee and there is general agreement the current system is not working very well. Major advantages of combining would be that there is a central place for discussing projects of common interest and limited staff resources would be used more effectively;~~
- ~~2. There is strong interest in creating a regional committee (as opposed to Albuquerque-only) since the bikeways and trail network is a regional system. This might either be City/County, or be more broadly regional, housed at MRCOG;~~
- ~~3. There are concerns that by combining all interest groups into one committee, the minority points of view will be lost;~~
- ~~4. There is a concern that recreational interests will be overwhelmed by the commuter/high-speed bicycle interests;~~
- ~~5. There is an acknowledgement that currently neither committee is truly working on pedestrian issues (e.g., sidewalks and creating a "walkable community");~~
- ~~6. There is a widely shared interest in having meaningful staff participation from various critical agencies in addition to the regular participation of DMD, P&R, MRCOG. These agencies could~~



include APD, NMDOT, Planning Department, Open Space Division, City Council, Risk Management, Bernalillo County, and others.

#### Overview of Other Communities' Bike/Pedestrian/Trails Programs

##### Tucson/Pima County

Tucson and Pima County transportation departments share staffing duties for the Tucson Pima County Bicycle Advisory Committee (TPCBAC). The TPCBAC is a huge committee, with representatives from local governments and agencies as well as representation from the Wards (equivalent to Council Districts), and representatives from unincorporated Pima County (which has a number of representatives). Most of the governmental reps are *ex officio* (i.e., non voting).

The TPCBAC meets once per month, but the real work occurs in the Executive Committee (5 members). The Executive Committee is made up of chair of each of 5 subcommittees: Facilities; Downtown and University; Law Enforcement, Education and Outreach; and Mountain bike/BMX. The Executive Committee and the full TPCBAC each meet once a month. Some of the subcommittee meetings are less frequent. From reviewing some of the agendas and minutes, it appears the TPCBAC deals with everything—ranging from bike boulevards to safety education to forest access. Tucson established a pedestrian advisory committee in 2013 due to a number of fatalities, and the bike/ped coordinator is concerned about how staffing will be handled.

The Pima Association of Governments (PAG) functions like MRCOG in regard to bicycle/ pedestrian issues: a count program, analysis of crash data, etc. There is a “Bike/Pedestrian subcommittee” at PAG that advocates for trails. It includes a variety of types of users, including an equestrian representative.

##### City of Minneapolis

The Bike/Pedestrian program is located in the Public Works Department. Two committees advise the Department: a Bicycle Advisory Committee (BAC) and a Pedestrian Advisory Committee (PAC). Staff members serve on the BAC. There are 13 citizen members representing the Wards, three Minneapolis Parks & Recreation Board (MPRB) members, and 12 agency and City department members (voting, except for the City Attorney). There are four staff for the Bike/Ped program. They coordinate closely with MPRB. MPRB has a completely separate staff, including trails specialists.

There are lots of other bike/ped/trails people in region (Hennepin County, etc.) and likely numerous other advisory groups. There is not really a group that meets regularly and discusses projects (funding and priorities). It happens on a project by project basis. There is a Met Council that includes the 7 counties (like MRCOG) and deals with federal funding allocations. Projects are implemented by City, County, and MPRB. The MPRB forms ad hoc committees for new or major renovation capital projects consisting of citizens, key neighborhood reps, interest groups, etc. There are also task forces that deal with discrete proposals.

##### Moreno Valley, CA

Moreno Valley has a Recreational Trails Board (RTB) that considers matters pertaining to single use and multi use recreational trails, including bicycle, jogging and equestrian trails within or

affecting the City. The nine member Board meets every other month. They are based in Parks and Community Services. Membership is by application, not based on type of trail user or council district. People are asked to provide their area of interest/goals, and the town council decides. According to staff, it has worked well. It seems the RTB is mainly trying to get people to adopt trails, and it also sponsors a regular, "Hike to the Top" foothills hike. They have a map of multi-use trails that are decomposed granite. The Public Works department consults with this committee on the design of asphalt trails.

#### League of American Bicyclists Recommendations

Regarding the particular issue of how other communities approach the structure of advisory committees, there is a recent publication by the League of American Bicyclists regarding Bicycle Pedestrian Advisory Committees that provides a good overview of the issues:

[http://www.advocacyadvance.org/site\\_images/content/bpac\\_best\\_practices\(web\).pdf](http://www.advocacyadvance.org/site_images/content/bpac_best_practices(web).pdf)

Pertinent to Albuquerque's situation, this article suggests:

the transportation agency be clear about the staff's role as liaison; the staff is responsible to the transportation agency, not the BPAC;

separating bike and pedestrians into different committees, if possible—it is difficult to find a balance otherwise

many issues noted by our Working Group: The committee should represent diversity of community (with targeted recruitment, particularly of females and minorities), have a very strong application process, conduct interviews, have term limits, make very clear the expectations for participation, provide orientation to new members, mentor new members, define the chair's responsibilities, and develop an annual work plan.

### **Advisory Committee Options for Albuquerque**

The City explored three different approaches to addressing some of the issues and concerns raised above:

1. **Status quo:** Continue two committees – GABAC/GARTC – staffed by DMD/P&R. Potential improvements to the process: 1) Clarify the role of the committees and integrate the advisory committee role in a more standardized manner into the planning and design process; 2) identify outside agency representatives as regular liaisons; 3) Improve recruitment and selection process for new members, advertise vacancies, develop a nomination process or other improved process for filling positions, conduct interviews, assure diversity and broad representation, have term limits and fill vacant positions quickly; 4) Provide trainings for advisory committees, provide packets with orientation materials for new members; 5) Improve meeting effectiveness, abide by rules of conduct for public meetings, utilize subcommittees to address particular areas of interest; 6) require staff from both Departments attend others' meetings to enhance coordination of activities; and 7) Provide more staff assistance in developing coherent drafts that articulate committee comments and positions on the issues they consider.
2. **Bicycle and Trails Advisory Committee:** A combined group of about 12 members balanced between cyclists and other trail users (equestrians, people with disabilities, pedestrians, hikers,

runners, skaters). Cyclists could be broken down into types to represent riders with different concerns: e.g., young, active elderly, commuter, off road, tourer, and possibly a bike shop business owner. Geographic, gender and ethnic diversity would be sought. This committee would be a Big Tent and consider and provide advice on the broad range of issues affecting implementation of the bikeways and trails network as outlined in the BTFP. Several areas of distinctly different interests might be handled by sub-committees that meet less frequently than every month. Two obvious subcommittees might be: 1) on-street cycling staffed by DMD or another transportation engineering agency (to cover the design of bike lanes and routes, connectivity, etc.) and; 2) unpaved trails staffed by P&R or Open Space Division (including, perhaps, being charged with developing a plan specific to these types of trails and trail users). Reports from these committees could be provided to the full group in summary form. Ideally, this would be a regional committee and the major topics that affect the urban bikeway and trails network would be addressed by the full committee. The City of Albuquerque is discussing potential for cooperation with MRCOG and Bernalillo County.

3. **Albuquerque or Regional or City/County Bike and Pedestrian Advisory Committee:** Create one committee with representation by geographic regions which reflects the diversity of the community – age, gender, and type of travel. Consider: inclusion of representation from major established advocacy groups and ex officio agency representatives. This is the structure most communities utilize in some form. For general guidance, see the Advocacy Advance publication: *Best Practices for Bicycle and Pedestrian Advisory Committees* at: [http://www.advocacyadvance.org/site\\_images/content/bpac\\_best\\_practices\(web\).pdf](http://www.advocacyadvance.org/site_images/content/bpac_best_practices(web).pdf)

### ***Considerations regarding moving to single committee structure***

In Albuquerque, this structure could leave out some users of the unpaved trail network, such as equestrians and hikers. There have been several suggestions about how to address this issue: create a standing subcommittee of the Open Space Advisory Board (or include equestrian representation on that Board and the P&R Advisory Board) and establish a process for regular communications with related land management agencies such as the MRGCD, US Forest Service, BernCo, etc.

**Pedestrian issues:** The BTFP recognizes the need for Albuquerque to develop a Pedestrian Plan. The issues specific to sidewalk inventory upgrades, safety and general walkability of the City are not currently being addressed by either of the existing committees. The City should make an effort to formalize its approach to obtaining citizen input on pedestrian issues. Several GARTC members suggested that it's not ideal to combine a pedestrian and bike committee. Many cities have a separate Pedestrian Committee and this approach should be considered in Albuquerque's future planning efforts – perhaps incorporated into the Complete Streets initiative.

**Staffing:** If Albuquerque moves to a single committee structure, the question arises as to how to staff the committee. Here are some options for input from the advisory committees. Any of these options will need to be reviewed by the City and other affected agencies:

1. **Planning Department.** If staffed by the Planning Department, participation and support of DMD and P&R would be essential. Responsibility for staffing the subcommittees (on-street cycling and unpaved trails subcommittees respectively) might be one way to insure that this occurs.



2. [DMD. By way of example, in Minneapolis, the transportation department staffs the bicycle and pedestrian committees. The Parks Board, which is an independent organization which builds and maintains most of the extensive trail system, has 3 board members represented on the bike committee.](#)
3. [Parks & Recreation. The Bike Safety and Education program, trail maintenance, and many of the trail design functions are currently housed in P&R. DMD would need to commit to a strong involvement and presence.](#)
4. [Joint City/County. Would require exploration with the County to determine appropriate staffing. This is the Tucson-Pima County structure.](#)
5. [MRCOG. Would require coordination with MRCOG to assess feasibility and how to structure.](#)

The Working Group will continue to consult with GABAC and GARTC and obtain input from the public and other agencies regarding the structure of the Advisory Groups.

#### **4. Policies for Bikeway & Trail Development**

The following objectives and policies were developed as part of the 2000 Comprehensive On-Street Bicycle Plan. They were intended to be completed by 2020, and still remain applicable to guide bikeway & trail development in the City. [This section outlines a more specific approach to implement the \*Bikeways & Trails Facility Plan\* Goal 1 & 2: “Improve the cycling and pedestrian experience.” and “Develop a continuous, interconnected, and comprehensive system of bikeways and trails.”](#)

##### **Objective 1: Develop and Promote Albuquerque as a Bicycle-Friendly Community**

1. Achieve the League of American Bicyclists’ Bicycle Friendly Communities award designation and Bicycling Magazine’s Top Ten Best Cities for Cycling award by institutionalizing bicycling as a legitimate form of transportation in all planning and programming efforts and public awareness campaigns.  
*Measurement:* Report the results of the survey and identify solutions to rectify deficiencies reported by the award. [Review the LAB recommendations annually to determine among the most appropriate and necessary actions to implement this plan.](#)
2. Provide full-time staff positions dedicated to bicycle transportation and appropriate office budgets to promote bicycling within Albuquerque.
3. Support the establishment of designated personnel and appropriate office budgets in other Albuquerque Metropolitan Planning Area jurisdictions to address bicycling concerns.
4. Maintain the dedicated local funding source for construction and maintenance of bikeways and establish specific budget line items in the Albuquerque budget to support the provision of on-street and off-street bicycle networks and programs.
5. Institutionalize bicycling as a legitimate form of transportation through bicycle-friendly roadway design practices and through consistent, routine training of City of Albuquerque, MRCOG, and other jurisdiction staff. Maintain bicycle transportation planning and design. Work with the University of New Mexico and New Mexico State University to develop curricula for bicycle-friendly transportation system design.
6. Support the efforts of the Greater Albuquerque Bicycling Advisory Committee (GABAC) and the Greater Albuquerque Recreational Trails Committee (GARTC) to promote bicycling and improve

bicycle ~~safety hazard and injury reduction~~ through effective responses to GABAC and GARTC concerns. Provide staff liaisons from the City, Bernalillo and Sandoval Counties, and other area departments of transportation to attend GABAC and GARTC meetings and to work on GABAC and GARTC issues on a routine basis.

## **Objective 2: Develop and Maintain a Continuous, Interconnected and Balanced Bikeway and Multi-Use Trail Network**

1. Develop an interconnected network of bikeways on 1) local streets (bike routes and Bicycle Boulevards), 2) arterial streets (bike lanes), 3) along limited access arterials (separated multi-use trails), and 4) along arroyos, drains or utility easements. Encourage developers of walled subdivisions to provide connectivity between their developments and adjacent bikeways.
2. Link existing and proposed trails to form a connected network.
3. Improve bicycle connections between schools (elementary through college) and neighborhoods to encourage bicycling by children, teenagers and young adults.
4. Provide bicycle facilities at half-mile spacing intervals on average throughout the city. Increase on-street bikeway mileage from the current 365 to 500 by the year 2020 and 650 by the year 2030. Increase multi-use trail mileage from the current 175 to 200 in the year 2020 and 240 in the year 2030.

*Measurement:* Prepare ~~a biennial~~ an annual report of the bicycle facilities that have been constructed.

5. Give increased priority to achieving connectivity of the bikeway network when planning and programming all roadway and bikeway improvements as appropriate.
6. Plan, program, and implement special provisions for crossings of high-volume, multi-lane streets. Review successful treatments utilized within other communities for difficult crossings.
7. Concentrate bicycle improvements for a five-mile radius (“hub and spoke”) around major employment centers, schools, parks, and other activity centers.
8. Coordinate and develop interconnected bikeway improvements and standards between the City and adjacent jurisdictions, including Bernalillo County, Sandoval County, Los Ranchos, Rio Rancho, Corrales, and KAFB.
9. Monitor the implementation of elements within the *Bikeways and Trails* ~~Master-Facility~~ Plan and update the Plan at ~~five-four~~ year intervals.

## **Objective 3: Use Bicycle and Pedestrian Friendly Standards and Procedures for On-Street Bicycle Facilities and Multi-Use Trails**

1. Restripe ~~all~~ collector and arterial roadways (where ~~practical~~ designated on the Bikeways Map and per NACTO and AASHTO guidelines) to provide bike lanes, or minimum outside lane width of 14 feet.
2. Provide a striped bicycle lane or shoulder as described in chapter 23, section 5, subsection N of the City’s Development Process Manual, in conjunction with NACTO and AASHTO bicycle facility design guidelines, on all new, rehabilitated or reconstructed roadways, as indicated in the Master-Facility Plan.

3. Provide striped lanes/shoulders of at least five feet wide, from face of curb where curb and gutter exist, on all new or reconstructed bridges, underpasses, and overpasses, [where not otherwise constrained or to the extent feasible](#).
4. [Selectively](#) plan and design for bicycle travel with all intersection improvements - include 5-foot bike lanes or minimum curb lane widths of 15 feet through intersections.
5. Include a through phase for all traffic signal timing plans at signalized intersections on roadways having designated bicycle networks.
6. Modify existing or install new traffic signal detection equipment (i.e., inductive loop, video detection, or pushbutton) to make all traffic signals bicyclist-responsive [within need-based areas and as resources permit](#).
7. Implement other design considerations, per the current versions of the [NACTO Urban Bikeway Design Guide](#), the AASHTO Guide for the Development of Bicycle Facilities, the “Design Guidelines” section of this plan and other appropriate design reference guidelines.
8. Evaluate and adjust traffic signal timing of the vehicle phase change and clearance interval to provide adequate time for bicycles at signalized intersections on designated bicycle networks.
9. On all trails, develop strategies and use design techniques on available right-of-way to minimize conflict of use.

**Objective 4: Provide ~~a High Standard of an Elevated Emphasis on~~ Maintenance along Roadways & Trails**

1. With On-Street Bikeway and Multi-Use Trails, improve and fully fund the street maintenance and sweeping program. Establish the highest priority for allocation of street sweeping resources to sweeping all [bike routes and bike lanes in response to 311 requests and at least once per month and bike routes on local streets](#) a minimum of four times a year. Multi-use trail sweeping should be performed on a regular basis and as requested.

*Measurement:* Request the annual data on frequency of scheduled sweeping for the on-street bikeway and multi-use trail network, ~~along with the number and location of spot sweeping requests based on 311 call volume~~. Establish a database to track trends and provide data that can be used refine scheduled sweeping and maintenance budget request.

2. Establish weed and vegetation control procedures to reduce the occurrence of noxious weeds (i.e., puncture vine) and plants that block sight lines or grow within two feet of [trails or within](#) bicycle facilities.
3. [Effectively M](#)aintain street surfaces on designated bikeway and multi-use trails ~~to a high standard~~, including elimination of lip between paved surface and gutter, elimination of manhole/water valves in bike lanes and maintenance of bicycle-[safe](#)friendly railroad crossings, drain grates, and cattle guards. Avoid use of chip seal/coating wherever practicable.
4. Maintain bicycle facility pavement markings and signing. Missing or defective pavement markings and signs shall be replaced or repaired in a timely manner. Retro-reflectivity of pavement markings and signs shall be in accordance with current MUTCD requirements.
5. Maintain arterial and collector street surfaces, including those not designated as bikeways, on a routine basis to reduce hazards (e.g., potholes, debris) for bicyclists who use these facilities.



6. Establish timely responsiveness to maintenance requests from citizens through the use of the City's 311 Citizen Contact Center or website or other means for citizens to report concerns.  
~~Establish an agency goal of 48 hours to address these requests.~~  
*Measurement:* Monitor response time for the maintenance requests and provide follow-up on the type of response. Report annually the number and type of request being made.
7. Maintain bicycle routes and lanes ~~to high standards~~ through construction projects, referring to Chapter 6, "Temporary Traffic Control," of the MUTCD ~~and maximize maintaining~~ curb lane widths (i.e., provide lane widths of 14 feet or greater) through construction projects on roadways ~~that do not have bike lanes that would otherwise contain a bike lane or bike route~~. Where this is not feasible, provide appropriate bicycle friendly and reasonably direct detours and detour signing, ~~per NACTO, AASHTO, and/or other City standards~~.
8. Encourage a bottle deposit program in order to reduce littering of roadways and bike facilities with broken glass.

#### **Objective 5: Implement a Comprehensive Program to Increase Public Awareness of Bicycling**

1. Develop and use video and audio Public Service Announcements (PSAs) and other means, such as billboards, to promote general public awareness and acceptance of bicycling and to promote bicycle ~~safety~~ education. Target use of PSAs on television/local radio stations for specific community events, especially during the annual Bike Month.
2. Provide specific line item agency funding to support public bicycling awareness programs and "Share the Road" campaigns.
3. Encourage wide-spread support and participation by bicycle shops, bicycle clubs, the GABAC, GARTC, and other bicycle interest groups in efforts to promote public awareness of bicycling.  
*Measurement:* Monitor membership and/or participation and growth.
4. Increase public outreach efforts, including video and audio PSAs to educate motorists on bicyclists' rights and responsibilities. Encourage the inclusion of bicycling-related questions in motor vehicle driving license tests as a means to raise awareness of bicyclists' rights and responsibilities.
5. Heighten public awareness of bicycle planning efforts and ensure on-going citizen participation and support for bikeway development. Provide periodic news releases for bicycle planning and bicycle system development and actively solicit public input.
6. Work with major employers throughout the Albuquerque to encourage commuting by bicycle among their employees and to increase motorists' awareness to share the road.

#### **Objective 6: Educate All Bicyclists on Legal, ~~Safe,~~ and Predictable Behavior**

1. Develop, distribute, and update annually a bicycle map of the Albuquerque including the communities of Albuquerque, Los Ranchos, Rio Rancho, KAFB and metropolitan areas of Bernalillo County.
2. Distribute a user-friendly Bicycle Commuter Handbook, which includes commuting, ~~and safety~~ and safety tips and laws related to bicycling.
3. ~~Develop and f~~ully support a bicycle education program in Albuquerque's elementary and secondary schools as part of current physical education requirements.

4. Encourage and support head injury awareness and helmet use through awareness of state laws, educational brochures, and programs.
5. Provide full support for the ~~Bicycle/Pedestrian Safety Education Program~~ B&PSEP staff in their work on bicycle education and in developing and overseeing a program for bicyclist education.
6. Continue development and use of video and audio PSAs, as well as short instructional ~~safety~~ videos to promote proper and legal bicyclist behavior.
7. Continue and expand Police Bicycle Patrols and dedicate a distinct percentage of their time to educational efforts on proper bicycling behavior.
8. Provide specific line item funding to support bicyclist education.

*Measurement:* Report the annual budget that is used for bicyclist education.

### **Objective 7: Promote Trail Use and Bicycling as a Non-Polluting, Cost-Effective and Healthy Mode of Transportation and Recreation**

1. Continue and expand marketing efforts to promote bicycling as an alternate mode of transportation, especially through cooperative efforts with a regional Travel Reduction/Rideshare Program. Work with businesses to provide bicycle commuting information to employers and employees and to learn how bikeways to and from their locations can be improved.
2. Provide outreach and personal travel cost information that shows how bicycle transportation can be beneficial to both employees and students.
3. Prioritize implementation of multi-use trails, which contribute key linkages to the on-street bikeway network, including interim trail improvements where needed and spot ~~safety~~ trail improvements.
4. Promote air quality benefits of bicycling through public outreach efforts to major public and private sector employers, such as the University of New Mexico (UNM), KAFB, Sandia National Laboratories, Intel, and area schools.
5. Develop and support cash incentive programs to promote bicycling, such as parking cash-out allowances (i.e., cash payments to bicyclists in lieu of employer-provided parking) for City, UNM, KAFB, and other employees who work for public or private sector employers.
6. Develop and implement bicycle parking ordinances where they do not currently exist. Monitor and fine-tune existing local bicycle parking ordinances based in part on bicyclist and business feedback and recommendations.
7. Continue and expand the interface between bikes and buses, including such features as bicycle racks on all buses and bicycle racks and lockers at park-and-ride lots. Promote bike/bus programs through ABQ Ride literature and PSAs.
8. Develop and implement specific incentive programs to encourage existing businesses and other entities to provide facilities for bicycling, such as bicycle racks, bicycle lockers, changing areas, showers, clothes lockers, and guaranteed ride home programs.
9. Develop and distribute to employers short videos that promote bicycle commuting, demonstrate bicycle commuting tips, show ~~legal and safe~~ predictable safe and lawful riding techniques, and promote bicycling awareness and acceptance.
10. Promote organized bicycle events and racing on city streets as a means of increasing public awareness of bicycling as a viable sport for public viewing and participation.

11. Promote the health benefits of cycling as a way of reducing stress, increasing daily physical activity, minimizing the risk of coronary heart disease, and controlling weight effectively.

### **Objective 8: Develop and Implement a Traffic Law Enforcement Program for Bicyclists and Motorists and Linked with Education Program Efforts**

1. Update or develop materials for use by law enforcement personnel to support education and enforcement efforts.
2. Commit appropriate police time (bicycle and motor vehicle patrols) to target bicyclist and motorist enforcement efforts.
3. Develop and implement a consistent, balanced traffic law education program for law enforcement personnel for improving motorist and bicyclist compliance with traffic laws.

### **Objective 9: Develop and Maintain Databases Useful for Bicycle Planning, Prioritization of Bicycle Improvements and [Accident-Crash](#) Prevention**

1. Periodically conduct community-wide public opinion surveys to: 1) determine reasons why people do or do not ride bicycles; 2) develop bicycle trip patterns and purposes; and 3) gain input on bicycle projects and programs that could improve bicycling in Albuquerque.
2. Routinely conduct and update bicycle counts to estimate usage levels and to help determine progress toward achieving future bicycle mode split goals. Conduct before and after bicycle counts for roadways that are reconstructed or restriped to have bicycle lanes and for other improvements to bikeways to gauge the effect of prioritized improvements.
3. Maintain and update the bikeway and multi-use trail network inventory developed as part of the planning process. Maintain and update the bicycle [accident-crash](#) database. Use the database to identify high [accident-crash](#) locations and/or high [accident-crash](#) severity locations to help prioritize bicycle project and program improvements. Review each bicycle collision/[accident-crash](#) ~~in a timely manner to identify system deficiencies and potential improvements. in order to assess site conditions to determine if the incident location could be targeted for system improvement.~~

## **5. Procedures for [Trail](#) Design, Development, & Review**

The Design Development and Review Process was developed by the Parks and Recreation Department and is intended to be used for public as well as private trail development.

Private trails are to be constructed to City Trails Standards even if proposed to be maintained by a private entity in the unlikely case that the City may have to maintain the trail in the future. Private trails available for public use shall be included on the Trails Map. Private trails located within gated communities and maintained by a Home Owners Association shall not be included on the Trails Map.

All trails shall be reviewed and approved by the Parks Management Division and Trails Planner prior to review and approval for construction by the Design Review Committee (DRC).

### **[Trail System Implementation Approach](#)**

[The Comprehensive Plan identified a range of “Possible Techniques” for implementation of multi-purpose network of open areas and trail corridors, which is provided in Policy II.B.1.f. The](#)



implementation techniques relate to the planning and design of arroyo corridors and irrigation ditches and also include funding and safety measures. As the City explores new trail corridors, we should:

1. Incorporate a multiple use concept for suitable arroyos and irrigation ditches into corridor, sector, and site development plans.
2. Control development that would inhibit drainage or open space purposes of arroyos.
3. Obtain adequate right-of-way for multiple-use of designated arroyos in developing areas and coordinate design between the public and private sectors through subdivision and site development plan processes.
4. Require planning and construction of pedestrian, equestrian, and bicycle crossings where designated arroyos and ditches intersect major streets and highways as a component of transportation projects.
5. Identify trail corridors through rank three corridor and sector development plans to be dedicated by the Subdivision Ordinance. Fund trails and associated public amenities through Capital Implementation Program bond issues, and other financing methods.
6. Investigate use of ditch/acequia easements or rights-of-way for open space purposes. Coordinate planning efforts with property owners adjacent to irrigation ditch system and the Middle Rio Grande Conservancy District.
7. Work with all public agencies and the State legislature to ensure that vacated irrigation ditch rights-of-way or easements are retained as part of the Major Public Open Space network.
8. Institute **safety barrier protection** measures along irrigation ditches before inclusion in any multi-purpose network.
9. Work with the private sector to establish motorized recreational vehicle areas separate from the pedestrian, equestrian, and bicycle-oriented trail corridors and Major Public Open Space network.

### **Developer Requirements/Future Trail Segment Construction**

Future proposed trails shown on the Bikeways and Trails Map and future Major and Minor Arterials and Collectors shall be built by developer at time of development.

Based on the latest population projections, the City can expect a significant increase in population, especially on the West side of Albuquerque. The recently released "Paseo del Norte High Capacity Transit Study Alternatives Analysis Report" dated August 2014 is proposing major changes in the way the residents of Albuquerque will travel around the City. A Bus Rapid Transit System such as the "Potential BRT Corridors" suggested in the Study could result in an increase in bicycle commuting as a way of supplementing a BRT mode for access to the Major Employment Centers as well as to Parks, Open Space, Trails, Libraries, Community Centers and other public facilities. Although the Bikeways and Trails Facilities Plan will precede any adoption of a BRT program for the City, the Bikeways and Trails Plan may be updated in the near future to include bicycle commuting w/BRT and recreational access as part of a Transportation System. With more research and information, the City can develop policies that require coordination between City departments to assure access to bike facilities and trails. In the meantime, City policy remains that if a trail and/or bicycle facility is shown on the Trails Plan as proposed where a property is being developed, the development will be required to construct and maintain said facility. This policy is consistent with the 1993 Trails and Bikeways Facilities Plan policies.

As it is not possible to foresee the exact location of future development, new development within these developing areas shall also be subject to the following requirements:

Future development areas within the City boundary without a proposed roadway system shall be ~~identified in a future study and be shown on the Bikeways and Trails map in either shading or textured as considered to be~~ “Growth Areas.” These Growth Areas are envisioned to develop within the next 10 years as the City population and land area expand – particularly on the west side and in the southwest area. It is not possible to foresee the exact location of future streets; therefore, new development within this “Growth Area” shall be subject to the following requirements as roadways are approved and developed, regardless of whether they are identified on the Bikeways and Trails map:

1. The 1993 *Bikeways and Trails Facilities Plan* requires trail dedication and platted access for proposed trails shown on the Trails Map as part of the Development Review and Approval Process. This requirement shall remain with the adoption of this 2015 *Bikeways & Trails Facility Plan*.
2. Future development requests with major ~~or~~ arterials, minor arterials, or collector streets shall include provisions for off-street trails in addition to required sidewalks within the right-of-way. Major Arterials shall have minimum 10’ wide trail in addition to standard sidewalk on both sides of the roadway to reduce pedestrian and bicycle crossings of the streets. Local streets shall not be required to provide a separate bicycle facility. When new Development is proposed to provide a trail or trail corridor, a platted public access easement (“Neighborhood Pathway”) shall be granted to the City.
3. All public and private development shall be built to the minimum design standards, as adopted in the *Bikeways & Trails Facility Plan* and/or the Development Process Manual. Facilities that cannot meet these minimum standards shall demonstrate the need for a design variance and present the request to the Advisory Group, DMD Engineering Division, and the Bike and Trail Coordinators, as appropriate. DMD Engineering Division shall make the final determination.
4. It is the City Parks & Recreation Department’s policy that trails “in-lieu of sidewalk” will no longer be accepted. The design requirements for trails and sidewalks, as well as the patterns of use, are different and sometimes conflicting. Therefore, where trails are identified on the proposed facility map, they should be provided in addition to a sidewalk that meets City standards. Existing facilities that do not meet the design standards of a multi-use trail (as defined in Chapter 7) shall be considered asphalt sidewalks.
5. Where a proposed future trail is shown on the map to be on or to cross the property, the trail shall be built by the Developer to City Standards (as defined in Chapter 7) and dedicated to the City for public trail use. The Parks and Recreation Department must accept a trail for it to be included in the Trail System and on the Trails Map.
6. If a developer chooses to include trails within a subdivision, but a trail is not identified on the Bikeways and Trails Facilities Plan, it is still to be developed to City Standards (as defined in Chapter 7). If a proposed trail is built, but not accepted by City Parks and Recreation Department due to the trail not meeting the minimum requirements of the Design Manual and any other City Standard Specifications, or if the Department determines that the trail does not meet needs of the overall trail system, a trail maintenance agreement will be created to identify the owner or

developer that will take maintenance responsibility for the trail. The City will therefore be relieved of liability for that particular trail or trail section.

7. If a trail cannot be built by the Developer at the time of development review and approval, due to development phasing or other necessary delay, a trail easement for public use shall be dedicated to the City.

4-8. Where trails are provided, a sidewalk may be on only one side of the street if the other side of the street is constructed with a minimum 3' wide soft surface stabilized crusher fines path adjacent the minimum 10' paved trail surface.

5-9. Trails designation and approval shall occur at the Development Review Board (DRB) and design shall be reviewed and approved by the Parks Management Division prior to the Design Review Committee (DRC). All paved trails are to be designed to accommodate different types of users – including cyclists (upright, recumbent, and children), pedestrians (walkers, runners, people using wheelchairs, people with baby strollers, people walking dogs), skaters, equestrians, and people with physical challenges.

6-10. Trails should be designed to meet the current ADA standards to the maximum extent feasible. Situations that warrant exceptions to this requirement include, but are not limited to, various constraints posed by space limitations, roadway design practices, slope, and terrain. At such time as new ADA standards are adopted by the U.S. Access Board, the City shall conform to those new standards.

7-11. The City will only maintain trails and bikeways that are approved for acceptance by the Parks & Recreation Department to be part of the Trail system, are situated built within the public right-of-way, and are built to City standards.

#### Documents to Revisit

- State of New Mexico Annotated Code
- City of Albuquerque Code of Ordinances
- City of Albuquerque Zoning Code
- Development Process Manual

## B. Legislative Recommendations

The State of New Mexico Code, City's Code of Ordinances, Zoning Code, and the Development Process Manual (DPM) were reviewed where they address the design and use of bicycle and trail facilities. In most cases these documents provide adequate information for developers, users, and law enforcement. However, to meet the goals set forth in this plan the following changes are recommended: Include an additional method for the hand signaling of a right-turn movement, add parking restriction in bicycle lanes and marked bicycle boxes, improve reporting of bicycle crashes by law enforcement, remove bicycle front fork size restriction, and consider redefining the way a bike lane width is referenced in the DPM when it is updated.

These three documents have extensive sections that pertain to the design and use of bicycle and trail facilities. In most cases these documents provide adequate information for developers, users and police; however to meet the goals set forth in the *Bikeways & Trails Facility Plan*, the following changes are recommended:



## 1. New Mexico State Motor Vehicle Code

New Mexico Code Chapter 66 contains statutes describing legal uses of roadways for all system users (e.g., cyclists as well as motorists). The following statute describes legal hand and arm signals:

**§66-7-327. Method of giving hand and arm signals:** All signals herein required given by hand and arm shall be given from the left side of the vehicle in the following manner and such signal shall indicate as follows:

- A. left turn: hand and arm extended horizontally;
- B. right turn: hand and arm extended upward; and
- C. stop or decrease speed: hand and arm extended downward.

**Proposed Change:** Amend subsection B to allow bicyclists to signal a right turn by extending their right hand and arm horizontally. Example language can be found in Oregon’s statute ORS 811.395.2.A, which reads, “To indicate a right turn, either of the following:

1. Hand and arm extended upward from the left side of the vehicle. A person who is operating a bicycle is not in violation of this paragraph if the person signals a right turn by extending the person’s right hand and arm horizontally.
2. Activation of front and rear turn signal lights on the right side of the vehicle.”

**Discussion:** While enclosure within a motor vehicle prohibits the use of the right hand for signaling in many situations, a cyclist has the potential freedom to signal turning movements with either the left or right hand. In addition to having this potential freedom, many youth educators recommend that signaling a right hand turn with the right arm can be less confusing for youthful riders.

The city can work with legislative advocates to amend the existing state law during a future legislative phase. The Bernalillo County Sheriff’s Office has been active in advocating for this change.

## 2. Traffic Code, Albuquerque Code of Ordinances

In general, there are some items about driver behavior towards bicyclists/pedestrians that should be added to the general traffic regulations, not buried IMO

### §8-5-1-1 Stopping, Standing or Parking Prohibited – No Signs Required

No person shall stop, stand or park a vehicle except when necessary to avoid conflict with other traffic or in compliance with the law or the directions of a police officer or traffic control device, in any of the following places:

**Discussion:** Bicycle lanes are travel lanes. It can potentially increase conflicts for cyclists using a lane to have to weave in and out of motor vehicle traffic to avoid cars parked in the bike lane. The DPM, in section N.3.c.2., also states the following:

*“Bike lanes are traffic lanes, therefore, automobile parking or motor vehicle use of a bike lane as a driving or passing lane should be prohibited.”*

Yet elsewhere in the DPM, Appendix A, Section a, is a statement that indicate that in bike lanes “vehicle parking and cross flows by pedestrians and motorists [are] permitted.”

**Recommendation:** Add the following:

- (O) In a marked bicycle lane
- (P) In a marked bicycle box

### **§8-5-1-15 Parking Not to Obstruct Traffic**

No person shall park a vehicle upon a street, other than an alley, in such a manner or under such conditions as to leave available less than ten feet of the width of the roadway for free movement of vehicular traffic.

**Discussion:** This section of the traffic code does not specifically address bicycle lanes as vehicular travel lanes. As discussed in above for §8-5-1-1, bicycle lanes should specifically be mentioned as a travel lane.

**Recommendation:** Add the following: “Bike lanes are traffic lanes, therefore, automobile parking or motor vehicle use of a bike lane as a driving or passing lane is prohibited.”

### **§8-2-9-1 and 8-2-9-2 Accidents, Reports**

**Discussion:** Bicycle crashes are under-reported and a complete record of bicycle related crashes in the City will be a valuable tool for future planning, identification of roadway conflicts and identification of areas in need of better enforcement of traffic laws.

**Recommendation:** Each of the items in these two sections should be re-worded to clearly include bicycle crashes.

## **3. Zoning Code, Albuquerque Code of Ordinances**

### **§14-16-3-1 Off-Street Parking, Parking for Bicycles**

An applicant for a building permit for construction of a new building or building addition of 200 square feet or more shall provide parking in accordance with the general requirements of this section. In addition, new buildings and building additions over 2500 square feet constructed after November 1, 2002 shall also be required to comply with all parking design requirements set forth in this section.

(B) Parking for bicycles shall be provided on-site or on a site within 300 feet of the use, measured along the shortest public right-of-way, as follows:

- (1) Residential use, five or more dwelling units or mobile homes per lot: one bicycle space per two dwelling units.
- (2) Dormitory, fraternity or sorority house: one bicycle space for each six persons in residence.
- (3) Nonresidential uses: one bicycle space per each 20 parking spaces required for automobiles and light trucks, but not less than two spaces per premises, unless otherwise specified below:
  - (a) Drive-in theater, mortuary, or motel or hotel rental unit: None.
  - (b) School elementary and middle: one bicycle space for each 20 students.
  - (c) School high, commercial, and trade: one bicycle space for each 50 students.

**Discussion:** The trigger for requiring bicycle parking is new construction or an addition over 200 square feet in multi-family residential and non-residential developments. Bicycle parking requirements are

based on the total number of vehicle spaces required for each different land use type, which is described in §14-16-3-1(A). There are additional requirements for schools, which are likely to have a higher number of cyclists. The existing bicycle parking code does not include requirements for long-term parking.

**Recommendation:** Add parking requirements for long-term bicycle parking, where applicable. The following rates are provided for consideration from the 2010 Bicycle Parking Guidelines produced by the Association of Pedestrian and Bicycle Professionals. The minimum requirement for long term and short term parking is 2 spaces each. [The General Parking Regulations should also be revised to add more specificity in the type of rack and spatial dimensions of bicycle parking areas according to the APBP guidelines.](#)

#### [Standard Bicycle Parking Rates:](#)

**Civic/Cultural – Non-assembly** (library, government buildings, etc.): 1 space for each 10 employees, long-term parking; 1 space per 10,000 SF building area, short term parking

**Civic/Cultural – Assembly** (Church, stadium, park, etc.): 1 space for each 20 employees, long-term parking; short term parking for 2% maximum expected daily attendance.

**Health Care/Hospital:** 1 space for each 20 employees, long-term parking; 1 space per 20,000 SF building area, short term parking.

**Rail/bus terminals and stations/airport:** spaces for 5% of projected am peak period of ridership, long term parking; spaces for 1.5% of projected am peak period daily ridership.

**Retail – food sales:** 1 space for each 12,000 SF of building area, long term parking; 1 space for each 2,000 SF of building area, short term parking.

**Retail – general:** 1 space for each 12,000 SF of building area, long term parking; 1 space for each 5,000 SF of building area, short term parking.

**Office:** 1 space for each 10,000 SF of building area, long term parking; 1 space for each 20,000 SF of building area, short term parking.

**Auto-related** (automobile sales, rental and delivery, automobile repair, servicing, and cleaning): 1 space for each 12,000 SF of building area, long term parking; 1 space for each 20,000 SF of building area, short term parking.

**Manufacturing and Production:** 1 space for each 15,000 SF of building area, long term parking; the number of short term parking spaces required is prescribed by the Planning Director.

#### **4. Albuquerque Development Process Manual (DPM)**

[The City aims to create a Unified Development Ordinance \(UDO\) that will modernize and update the standards provided in the Development Process Manual \(DPM\). This effort will take place over the next several years, and the portions that relate to trails and bikeways should consider the standards and practices developed in this Facility Plan. Generally, the current DPM or a future UDO should update the standards for bicycle facilities to align with and reflect modern best practices, such as provided in this document and the NACTO Bike Guide.](#)



**Volume II, Chapter 23, Section 1, Governing Regulations:** This list of City regulatory documents pertaining to street design should be modified to reference the *Bikeways & Trails Facility Plan, Chapter 7, Design Manual*, for the design and specifications of bikeway and trails.

**Volume II, Chapter 23, Section 5, Miscellaneous Street Design Criteria, N.1.2.a. Development of Bike Lanes on New or Reconstructed Roadways:** Cross section diagrams show the bike lane measured from edge-line of the outside lane to the face of the curb. The language in the manual indicates the measurement should be from the painted edgeline to the edge of gutter asphalt pavement. The ~~diagrams~~ **Figure 2** should be updated to match the text.

**Discussion:** The guidance given is contradictory and should be consistent to ensure the desired outcome.

**Volume II, Chapter 23, Section 3, Engineering Design Criteria:** The list of guidance documents should be amended to reflect more current documents and best practices. The list should include documents listed in Chapter 7 of this Plan, including:

- AASHTO Policy on Geometric Design of Streets and Highways, 2012
- Manual on Uniform Traffic Control Devices (MUTCD), 2003
- Public Rights-of-Way Accessibility Guidelines (PROWAG), 2007
- ADA Final Guidelines for Outdoor Developed Areas, 2013
- National Association of City Transportation Officials (NACTO) *Urban Bikeway Design Guide*, 2014.

## C. Maintenance & Operations Recommendations

### 1. Trails Maintenance Practices & Policies

#### Current Practices

The current Park Management maintenance protocol is to:

Maintain a clear 3' recovery zone on both sides of trails, spraying for weeds both sides of trails, mowing both sides of trail to keep weeds and grasses at a manageable height, sweeping trails on an as-needed basis. Asphalt repairs include filling in cracks and remove and replace sections of trail as needed. This is limited due to funding and staffing, major repairs need to be contracted when funding is available. Painting and replacing bollards as needed, sign replacement and installation as needed, pruning of trees and shrubs that encroach into bike trails; this is on an as needed basis.

In practice, however, this procedure may not be effective, and more detailed written procedures for systematic evaluations, routing and preventive work, as well as spot repairs are needed. And these will have little meaning unless there are adequate staff and resources to perform the work. Park Management's work is largely driven by 311 complaints; and there is a backlog of complaints, some of which are duplicative. Staffing for trail maintenance has not significantly increased since 1993 when there were 39 miles of trails; now, Park Management maintains about 150-Miles of paved trails. In 2014, responsibility for the maintenance of the medians was transferred from Park Management to Solid Waste. It is hoped that by separating the functions, the City can develop a sustainable and effective trails maintenance program. Park Management is implementing the YARDI system. This will help with scheduled maintenance and made the 311 dispatching system much more efficient.

Bernalillo County, Open Space Division, and NMDOT also maintain paved trails in the Albuquerque area. In addition, AMAFCA, MRGCD, ~~COA Street Maintenance~~, and ~~Weed and Litter~~ other agencies may perform work along trail corridors. There is sometimes informal coordination and occasional opportunities for cooperation, but there is no regular coordination among crews working in the same area.

One of the most common complaints is weed control, especially Puncture Vine (goat heads). Effective weed control is highly dependent on timing. Limited manpower limits the ability to apply herbicides at the optimum time. City Open Space [Division](#), which has a full time worker to manage a portion of the Paseo del Bosque Trail, has managed to reduce the goat head population because of his ability to stay on top of the problem.

#### Trail Maintenance Recommendations

##### Best Management Practices

PM should establish maintenance standards and a schedule for inspections and maintenance activities and move away from the 311 driven maintenance approach. Maintenance programs can be divided into three levels depending upon the frequency of services needed:

- Yearly evaluation to address items such as crack repair, sign replacement, painting, repairs (fencing, gates, benches, etc.) drain clearing and facility evaluation.

- Regular maintenance: Weed control (spraying and manual), mowing, sweeping, pruning, trash removal, empty trash cans and dog waste dispensers.
- As needed: Flood or rain damage repair (silt clean-up, culvert clean out, etc.), bollard repair, graffiti removal, snow/ice removal, irrigation repairs, other immediate [safety-hazard remediation](#) issues.

The City should work toward appropriate funding for trail maintenance with a goal to meet national standards for best management practices. To meet these standards requires adequate staffing, equipment, and supplies. PM is currently funded at about 60% of the national standard for maintaining each mile of asphalt trail. PM is upgrading its equipment to obtain smaller, more maneuverable equipment more suited to working on the trails without causing damage or disturbing desirable vegetation.

### ***Division of Maintenance Responsibilities and Need for Collaboration***

The number of agencies responsible for different sections of the trail network, or who have partial responsibility for maintenance of a trail corridor such as graffiti removal and weed control (in the broader corridor outside the narrowly defined trail corridor), or for at-grade crossing of streets, makes coordination of maintenance difficult.

In general, Park Management is responsible for off-street trails and trails within neighborhood or regional park facilities, including trails along AMAFCA channels. Bernalillo County is responsible for trails outside of the City limits. The Open Space Division is responsible for trail within Major Public Open Space and trails along open space arroyos. Other agencies which have trail or bikeways maintenance duties include: Street Maintenance ([on-street only](#)), [Traffic Engineering \(signs and pavement markings\)](#), NMDOT, the National Park Service, neighborhood associations, and private parties (such as homeowner’s associations). In some cases, one agency is responsible for the day-to-day duties and another for the long term care of the trail itself; or one agency is responsible for the trail and another for the upkeep of the wider right-of-way.

[Governmental agencies responsible for trails are delineated in the \*Trails and Bikeway Facility Plan\*. Presently Park Management is responsible for off-street trails and trails within neighborhood or regional park facilities, including trails along AMAFCA channels. Bernalillo County Parks and recreation is responsible for trails outside of the City limits. The Open Space Division is responsible for trails within Major Public Open Space and trails along open space arroyos. These governmental agencies responsible for trails are delineated in the Bikeways & Trails Facility Plan Maintenance map \(Note: this is a general map and may not reflect all of the details regarding some segments of trail; and there are areas that need clarification\).](#)

[The number of responsible agencies makes coordination of maintenance difficult.](#) Possible solutions to some of the difficulties created by overlapping responsibilities include:

- [Creating a government agency whose primary responsibility is to maintain and promote trails in the region. However, a new level of government may be met with skepticism.](#)
- [Promoting the creation of a regional non-profit trails organization to maintain and support trails.](#)
- Work should continue among agencies to clarify and coordinate maintenance responsibilities.
- The City should pursue opportunities to share duties or trade responsibilities where it would be more efficient for one agency to manage an entire corridor.



- The City should evaluate if there is expertise in some departments that might be helpful to Park Management, for example, whether Street Maintenance or an on-call contractor for the City could help with crack repair, such as is done in Bernalillo County.
- The City should sponsor an annual “trail maintenance workshop” with presentations on practices and sharing of strategies and experiences. In addition to discussing issues and approaches it could help build relationships among various personnel, and provide a venue to clarify where there are opportunities to share responsibilities and promote more efficient use of resources. It could be internal to the City (Park Management, Weed and Litter, Street Maintenance, Open Space [Division](#), etc.) or broader, including Bernalillo County, NMDOT, MRGCD, AMAFCA, Rio Rancho, etc. An initial concept: AMAFCA has offered to host such an event in their conference room. There would be display maps for people to write on and facilitated discussions could cover subjects such as: practices, equipment, costs, future collaboration, overlapping responsibilities, and gaps. A summary of the discussions and outcomes would be prepared for the participants and managers.
- Looking at long term solutions, some considerations might include creating a cross-jurisdictional agency whose primary responsibility is to maintain and promote trails in the region, or promoting the creation of a regional non-profit trails organization to assist in supporting maintenance of the trails.

### ***Inventory and Tracking***

An accurate inventory, keyed to the Trails Maintenance Map is needed, with consistent names, confirmed mileages, and clear beginning and end points. Park Management plans to implement the YARDI system which is an automated work order system. Supervisors will receive 311's in real time for their respective areas, triage and send to appropriate personnel to address and close out. Employees will be assigned a tablet that will be used to input, communicate and view assigned work. YARDI will be used to schedule preventive maintenance tasks (be more proactive) and for inventory control, including parts, tools, time and areas maintained by Park Management. Eventually, utilizing signage, quick read codes, web site and apps there will be a platform for use by patrons of the trail system. YARDI will assist in organizing responsibilities of Park Management for various trail corridors, keeping track of requirements of license agreements, and maintaining schedules for regular inspections (as the system is being developed, these details are being included). The database and regular usage will allow PM to provide feedback to the trails community regarding how/when reported problems will be corrected.

### ***Weed control and establishment of native grasses and plants***

Effective weed control is highly dependent upon timing and ability to deploy manpower, whether removal is manual or chemical.

- The City should protect existing stands of native grasses and forbs and establish new stands to create a vegetative cover that is drought tolerant and reduces the intrusion of noxious weeds, overtime reducing the need for herbicides. This would make the trails more pleasant for users, less maintenance intensive, assist in preventing erosion at the edge of the asphalt, and address one of the most common citizen complaints about trail maintenance: goat heads.
- The entire right-of-way should be considered, in cooperation with other agencies that have responsibilities for maintenance in the corridor.

- Park Management might also support in-house training of workers to recognize desirable natives versus noxious weeds.
- More details on the how to address the problems with weeds are included in the Design Manual.

### **Upgrade the existing trails system to address maintenance issues**

Parks should utilize capital project funding to develop an on-going urban trail renovation program. This would include evaluating priority trail rights-of-way for: ~~safety issues~~ ~~potential hazards~~; potential for establishment of native grasses and forbs; ADA upgrades; replacement of bridge decking; locating opportunities for amenities (such as seats and shade structures, and occasional trees and shrubs where feasible); bollard relocation; signage upgrades; and separation of user types where desirable.

- Projects should be coordinated with other infrastructure upgrades (arroyo channel repairs/replacement, asphalt trail re-surfacing, etc. and various funding sources should be evaluated, including: trail renovation funding in CIP program; participation from agency that owns and has responsibility for the right-of-way outside of the trail corridor (Street Maintenance, NMDOT, AMAFCA, other); and coordination with 50-Mile Activity Loop funding.
- Input should be sought from trail users, neighborhoods, trails maintenance crews, 311 logs and staff regarding priorities and guidance on how to implement specific projects.
- The Design Manual should be followed and re-seeding and mulching should be in compliance with City Standard specifications, modified if necessary to meet multiple objectives (e.g. erosion control).
- For major projects, the design engineer/landscape architect should include a concept plan for the long-term maintenance protocol if there are needs specific to that project that vary from routine maintenance practices.
- Park Management should evaluate each project as it is completed after one year and re-seed as necessary until grasses establish.

### **Use of volunteers and other workers**

Park Management should maximize the use of volunteers, seasonal employees, community service workers, and inmate crews to enhance their ability to address problem areas. Use of volunteers requires a commitment of some employees with Saturday hours and ability to build regular communications with committed volunteers. The Adopt-a-Trail program hasn't been particularly effective thus far, but this program and trails clean up days (such as Company's Coming and National Trails Day) can have an impact with proper preparation and support. Community service workers haven't been utilized on trails due to the inconsistency of numbers available and difficulty of managing over a linear system. Inmate crews are reliable, but require organizational efforts up front and, again; management oversight is a big issue. Park Management should conduct strategic planning with key agencies and staff who are currently involved in these issues to consider how to best utilize these resources on the urban trails.

### **Maintenance Schedule**

~~Maintenance programs can be divided into three levels depending on the regularity of services needed.~~

- ~~• Regular maintenance, performed weekly or monthly, includes such activities as mowing and landscape maintenance, sweeping and litter removal.~~
- ~~• Periodic maintenance, performed annually, includes crack repair, sign replacement, painting, drain clearing and facility evaluation.~~

- Occasional maintenance includes resurfacing or sealing the asphalt widening and furnishing replacement. This last level of maintenance can be accomplished on an as-needed basis.

Governmental agencies responsible for trails are delineated in the *Trails and Bikeway Facility Plan*. Presently Park Management is responsible for off street trails and trails within neighborhood or regional park facilities, including trails along AMAFCA channels. Bernalillo County Parks and recreation is responsible for trails outside of the City limits. The Open Space Division is responsible for trails within Major Public Open Space and trails along open space arroyos.

The number of responsible agencies makes coordination of maintenance difficult. Possible solutions include:

- Creating a government agency whose primary responsibility is to maintain and promote trails in the region. However, a new level of government may be met with skepticism.
- Promoting the creation of a regional non-profit trails organization to maintain and support trails.

## **2. On-Street Bicycle Facilities Maintenance Considerations Practices & Policies**

See the recommendations in **Section 7.F of Chapter 7, Design Manual**. [Also see the Policies for Bikeway & Trail Development, Section 6.A.4, Objective 4, “Provide an Elevated Emphasis on Maintenance along Roadways & Trails.”](#)

### **Current Practices**

For on-street bikeways, pavement preservation, signs, pavement markings and sweeping are the responsibilities of Municipal Development, typically through the Street Maintenance Division or Traffic Engineering Division. City streets are swept a minimum of four times per year on average, and upon request according to 311 calls that report debris in the roadway.

### **On-Street Facility Maintenance Recommendations**

Like all roadways, bike lanes, routes, and bike boulevards require regular maintenance. This includes sweeping, maintaining a smooth roadway, and ensuring that the gutter-to-pavement transition remains relatively flat and installing bicycle friendly drainage grates. These considerations are particularly relevant to bike lanes, as cyclists have a narrow corridor to traverse.

### **Best Management Practices**

Effectively maintain street surfaces on designated bikeway and multi-use, including elimination of lip between paved surface and gutter, elimination of manhole/water valves in bike lanes, installation of bicycle-friendly drainage grates, and maintenance of bicycle-friendly railroad crossings, drain grates, and cattle guards. These types of projects are typically accomplished through a facility redesign project, which would be led by DMD’s Engineering Division.

Avoid use of chip seal/coating wherever practicable. Use a small aggregate chip seal when resurfacing roads, and provide a level transition with the existing concrete gutter pan. Maintain arterial and collector street surfaces, including those not designated as bikeways, on a routine basis to reduce hazards (e.g., potholes, debris) for bicyclists who use these facilities. These maintenance actions are generally the responsibility of DMD’s Street Maintenance Division.

Maintain bicycle facility pavement markings, and pavement signs, signing and pavement loop detectors, and other signals. Missing or defective pavement markings and signs shall be replaced or repaired in a



timely manner. Retro-reflectivity of pavement markings and signs shall be in accordance with current MUTCD requirements. These maintenance actions are generally the responsibility of DMD's Traffic Engineering Division.

Establish timely responsiveness to maintenance requests from citizens through the use of the City's 311 Citizen Contact Center or website or other means for citizens to report concerns. This practice could be measured by monitoring response time for the maintenance requests and provide follow-up on the type of response. Report annually the number and type of request being made. This monitoring action could be completed by the City's bikeway coordinator.

Establish weed and vegetation control procedures to reduce the occurrence of noxious weeds (i.e., puncture vine) and plants that block sight lines or grow within two feet of trails or within bicycle facilities. Encourage a bottle deposit program in order to reduce littering of roadways and bike facilities with broken glass. These efforts could be led by the City's bike coordinator in conjunction with Parks & Recreation, Solid Waste, Planning, and City Council.

### **Maintenance of bicycle routes during construction**

Maintain bicycle routes and lanes through construction projects, referring to Chapter 6, "Temporary Traffic Control," of the MUTCD maintaining curb lane widths (i.e., provide lane widths of 14 feet or greater) through construction projects on roadways that would otherwise contain a bike lane or bike route. Where this is not feasible, provide appropriate bicycle friendly and reasonably direct detours and detour signing, per NACTO, AASHTO, and/or other City standards.

### **Maintenance Schedule**

With On-Street Bikeway and Multi-Use Trails, improve and fully fund the street maintenance and sweeping program. Establish the highest priority for allocation of street sweeping resources to sweeping all bike routes and bike lanes in response to 311 requests and a minimum of four times a year. Multi-use trail sweeping should be performed on a regular basis and as requested. Street Maintenance has one sweeper dedicated to bicycle lanes and to respond to 311 requests; typically bikeways are swept as part of regular road sweeping.

Measurement: Request the annual data on frequency of scheduled sweeping for the on-street bikeway and multi-use trail network, along with the number and location of spot sweeping requests based on 311 call volume. Establish a database to track trends and provide data that can be used refine scheduled sweeping and maintenance budget request. This monitoring action could be completed by the City's bikeway coordinator.

## **3. Citizen Maintenance Requests**

The City has in place a centralized reporting system, "Citizen Contact Center," that can be used effectively to report problems and request maintenance. Several methods for reporting are available: call 311 by telephone, using Twitter and by visiting [www.SeeClickFix.com](http://www.SeeClickFix.com). Comments are then routed to the appropriate people. To increase utilization of this service the City should promote its use by informing bike clubs and organizations and bicycle advocacy groups and consider developing a Public Service Announcement.

One of the challenges of the current 311 reporting system is that the case is closed after a work order is issued. There isn't a way for the public to know where in the queue their concern is to be addressed. The

City should explore adding another step to the 311 notification system that closes the loop after the work order is completed.

#### **4. Spot Improvement Program**

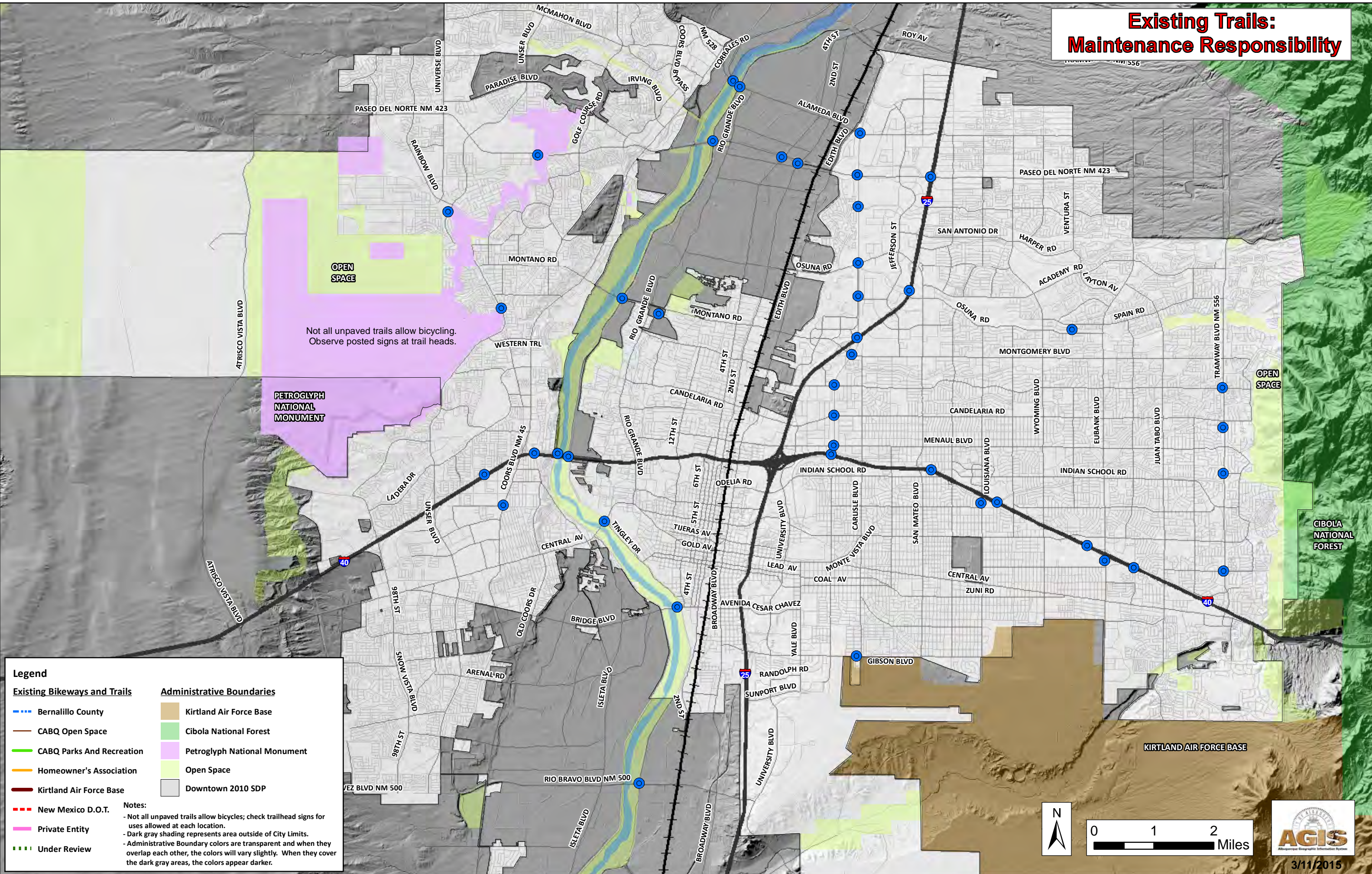
The City should consider implementing a “spot improvement” identification program where bikeways and trail users can provide recommendations. Soliciting comments from users can help the City identify specific problem locations that need maintenance and/or rehabilitation. Institutionalizing this process in the form of a spot improvement program can provide ongoing input and, in many cases, help identify problems before someone gets hurt. In addition, such a program can dramatically improve the relationship between an agency and the bicycling public.

|

|



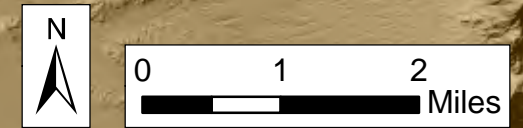
# Existing Trails: Maintenance Responsibility



Not all unpaved trails allow bicycling. Observe posted signs at trail heads.

**Legend**

<b>Existing Bikeways and Trails</b>		<b>Administrative Boundaries</b>	
	Bernalillo County		Kirtland Air Force Base
	CABQ Open Space		Cibola National Forest
	CABQ Parks And Recreation		Petroglyph National Monument
	Homeowner's Association		Open Space
	Kirtland Air Force Base		Downtown 2010 SDP
	New Mexico D.O.T.	<b>Notes:</b>	
	Private Entity	- Not all unpaved trails allow bicycles; check trailhead signs for uses allowed at each location.	
	Under Review	- Dark gray shading represents area outside of City Limits.	
		- Administrative Boundary colors are transparent and when they overlap each other, the colors will vary slightly. When they cover the dark gray areas, the colors appear darker.	



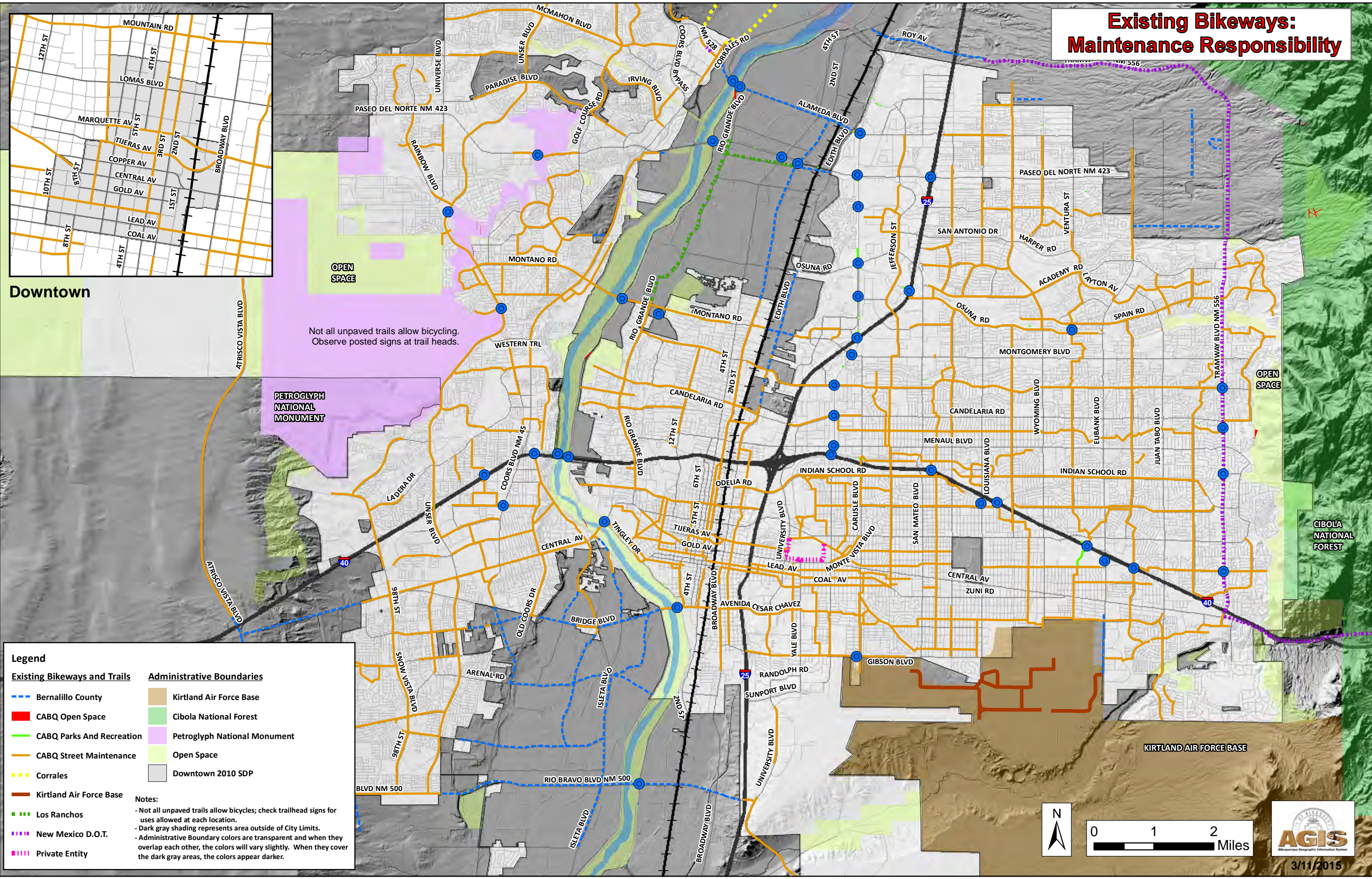
3/11/2015



# Existing Bikeways: Maintenance Responsibility



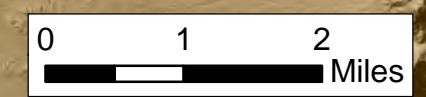
Downtown



Not all unpaved trails allow bicycling. Observe posted signs at trail heads.

**Legend**

<b>Existing Bikeways and Trails</b>	<b>Administrative Boundaries</b>
--- Bernalillo County	■ Kirtland Air Force Base
— CABQ Open Space	■ Cibola National Forest
— CABQ Parks And Recreation	■ Petroglyph National Monument
— CABQ Street Maintenance	■ Open Space
--- Corrales	■ Downtown 2010 SDP
— Kirtland Air Force Base	
--- Los Ranchos	<b>Notes:</b>
--- New Mexico D.O.T.	- Not all unpaved trails allow bicycles; check trailhead signs for uses allowed at each location.
--- Private Entity	- Dark gray shading represents area outside of City Limits.
	- Administrative Boundary colors are transparent and when they overlap each other, the colors will vary slightly. When they cover the dark gray areas, the colors appear darker.



3/11/2015



## D. Monitoring & Evaluation

For evaluation efforts, the City's top priority should be to perform Annual Bicycle and Trail Counts. The resources needed to support this effort will primarily be staff time, so a lead city staff person should be identified who is able to set aside sufficient time to manage the count effort. Many communities seek volunteers to do the counts. It is recommended that the City follow the National Bicycle and Pedestrian Documentation Project (NBPDP) methodology, which recommends counts in September. The advantages of starting with the NBPDP approach is that a) count forms, training materials and instructions are ready for use and b) the results can be compared with communities around the U.S.

### 1. Trail and Bikeway Counts

#### User Counts

**Annual or semi-annual counts:** The City should consider participating in the annual National Bicycle and Pedestrian Documentation Project. This will help to better estimate existing and future bicycle and pedestrian demand and activity. This nationwide effort provides consistent model of data collection and ongoing data for use by planners, governments and bicycle and pedestrian professionals. Annual counts are normally conducted in mid-September. Additional a second set of counts, possibly in April, could be conducted at the same locations and time period of the September counts to better understand seasonal fluctuation in the number of cyclists. [If equestrian data is collected, the researcher should consult with equestrians for recommendations about locations, days, and times to perform user counts.](#)

**Day long counts:** The City should conduct day long (sunrise to sunset) counts at selected locations to better understand the off-peak user patterns and to accurately identify the peak user time of day. This data can reveal the recreational and utilitarian usage of the bikeways in the city.

**Counts at high crash location:** At locations identified as having experienced greater than normal crashes with motor vehicles the City should conduct bicycle user counts. These counts can provide data to help in the determination of the greater than normal crash rate. Evidence has shown that as ridership increases, crash rates decrease. It has been speculated that this can be attributed to the expectation of cycling activity.

**Permanent count locations:** Permanent, automated bicycle count locations can be established where the City would like to record daily bicycle use. The location selected can be based on the type of target user group such as commuters, recreational, utilitarian and students. The information gathered can be used in determining commute mode-share, provide a fuller understanding of variation of use by time-of-day, season, weather and special events and provide supporting evidence of the change in use of the targeted facility.

- Consider day-long counts at along key corridors to determine daily citywide use.
- Consider counts along high crash corridors without existing bicycle facilities to determine current level of use.
- Conduct annual or semi-annual counts at selected locations on bikeways and multi-use trails across the city.

### 2. Crash Data Collection & Analysis

**Approach to Crash Data Collection:**



- The detailed crash analysis presented in this report should be **repeated every few years** to identify high crash locations and solutions to improve [safety conditions](#) for non-motorized transportation users. This could be done as a part of a periodic bikeway and multi-use trails ‘report card’ that documents relevant metrics, including new bikeway miles, new trails and crossings, major completed projects, number of bicycles and other trail users, crash analysis, user satisfaction, public perception of [safety facilities](#), etc. This periodic review could be used to create updates to the *Bikeways & Trails Facility Plan* that can tune the plan’s implementation strategies to respond to changing [safety, best practices and](#) walking and bicycling patterns.
- The City should consider **education or enforcement programs** that address specific causes of crashes involving bicycles and other non-motorized transportation users. The most frequent type of crashes were instances where a car hit a bicycle at an angle.
- The City should consider a **detailed analysis of conditions along top crash corridors and at top intersections**. This analysis should help the city determine whether the higher numbers of crashes are related to difficult conditions or higher numbers of cyclists using the corridor.
- The majority of reported bicycle crashes have occurred on major roadways with four to six travel lanes, no dedicated bicycle facilities, and posted speeds of at least 35-mph. Future roadway design and corridor retrofit of these corridors should focus on **increasing safety through increased bicycle/vehicle** separation and enhanced crossing treatments.

### 3. Survey

The City should consider conducting a survey of the bicycle and trail users. This survey could be led by a local advocacy organization under the direction of the City. The survey results could be used to evaluate the City’s progress and identify areas of concern and evolving needs of the users.

- Consider programs to increase bicycle parking at high priority locations across the city.
- Continue and when possible expand education, encouragement and enforcement programs. Target these programs to key groups that are under-represented in the city’s current cycling demographic including women and groups that would benefit from education such as school age children.
- Consider placing high priority on filling gaps in the multi-use trail network.

## E. Funding

### 1. State and Local Sources

#### New Mexico Department of Transportation

The Department of Transportation provides funds to match Federal-aid projects on New Mexico and U.S. highways within Albuquerque. [State and Federal Transportation Improvement Funds are administered through the MRCOG.](#)

#### New Mexico Legislature

During its annual legislative sessions, funds can be provided for bicycle projects through special appropriation bills (e.g., capital requests or memorials).

## 2. Local Sources

### Capital Implementation Program (CIP)

Funding for capital improvement projects is provided through the General Obligation (GO) bond program and Urban Enhancement Trust Fund (UETF). Both the City of Albuquerque and Bernalillo County have set aside 5% of the Public Works Streets portion of their GO bonds to be used exclusively for bicycle projects, beginning in 1995. ~~The City set aside is equally distributed between the on-street (2.5%) and trails (2.5%) programs.~~ The GO bonds are obligated in 2-year cycles, ~~generating \$600,000 for the on-street system biennially.~~ Additional monies from the CIP (e.g., major pavement rehabilitation or specific roadway construction projects) may be used for bicycle projects. On-street bikeways will be incorporated into new roadway construction and street rehabilitation/resurfacing projects wherever feasible.

### Gross Receipts Tax

A 1/4-cent gross receipts tax for fixing existing streets, building new roads, expanding transit and constructing bikeways/trails was approved by voters in 1999. A set percentage (4%) of this revenue, or \$1.65 million biennially, is earmarked for trails used for both commuting and recreational travel; however, no dedicated funds were specifically identified for on-street bikeway improvements.

### Land Development

There also exists an opportunity to work with the private sector to implement bicycle projects. This is accomplished through right-of-way dedications, infrastructure improvements and/or impact fees. ~~Impact fees are deposited to the City's General Fund, which is allocated through the CIP and GO Bond Process.~~

### Additional Funding Sources

Other funding opportunities include:

- City Council set-aside funds
- Municipal bonds
- Public/Private Partnerships
- Metropolitan Redevelopment Area projects
- Tax Increment Financing (TIFs), Special Investment Districts (SIDs), and Public Investment Districts (PIDs)

## F. Summary of Implementation Actions

The following matrix lists the actions that the City will complete to implement this *Bikeways & Trails Facility Plan*. The actions are grouped according to work that is currently ongoing as a part of our standard practice today. The other sections classify future actions or projects as Short-Term, Mid-Term, and Long-Term. This Implementation Matrix should be used as a summary of the recommended actions and as a guide to realize the goals and policies proposed in this Facility Plan.

The following section, Chapter 7 Design Manual, provides standards and guidance for the design of specific bikeways and trails and should also be consulted as an implementation guide to improve the quality of our bikeways and trail system.

Table 10: Implementation Matrix on page X is arranged with several categories: Type of Project, Priorities, Actions, Deliverables and Lead Agency. Listed under the heading Type of Project are: CIP/Network Improvements, Administration, Data Collection and Analysis, Interagency Coordination, Maintenance, Planning and Programs. Priorities are listed as Ongoing, Short-term, Mid-term and Long-term. The Actions, Measurements, and Lead Agencies vary, depending on the implementation requirements. The following is a summary of the contents of the table broken down by the Type of Project. For more detailed information, refer to the ID numbers listed that correspond to the ID numbers found in the table.

### **CIP/Network**

- Ongoing CIP/Network actions include increasing street bike mileage as well as trail miles and implementing new bikeways as roads are rehabilitated. (ID 1 & 7)
- Short-term action items include completing “Critical Links” identified in this Plan and assessing the need for new facilities. All new bridges, overpasses and underpasses should have a lane/shoulder of at least 5 feet. (ID 31, 32, 35 - 37)
- Mid-term actions will be using designs that minimize conflicts on trails and evaluating all collectors and arterials for striping to provide for bikes. Also prioritizing enhancements for unclear travel paths at major intersections and including major intersection improvements as part of the CIP. Strategies should be adopted for including trails and bikeways in all new subdivisions. (ID 57 - 61, 95)
- Long-term the plan calls for providing bike lanes or shoulders consistent with current development standards as well as AASHTO designs on all new or rehabilitated roadways and evaluating the extent of the system for each user type. In addition, the plan calls for developing and implementing a wayfinding network. (ID 99, 105, 106)

### **Administration**

- Ongoing Administration actions include working with citizen groups to promote bicycling and walking and improving biking and pedestrian safety. Also, to continue to support land use regulations that enable trails and bikeways to be built and support programs related to education, outreach and encouragement as well as maintaining and leveraging local funding for construction and maintenance of trails. Departments within the City should communicate and coordinate requests for funding and representation at MRCOG. (ID 2 - 6)
- Short-term action items call for updating the short-term priority construction list every two years in conjunction with the Decade Plan as well as monitoring and documenting the implementation of the project and implementation actions in the plan. An annual report will be produced as documentation of these items. Ensuring routine training of pertinent staff and MRCOG is occurring and developing improved project identification, design and development through a Project/Technical Team is also a short-term action item. Evaluating and making recommendations regarding the current advisory groups and their effectiveness is called for. Conducting a biennial meeting among agencies with a summary of the outcome transmitted to the Mayor and City Council is an important action item, as is adopting a Complete Streets Ordinance and developing a city-wide policy for maintenance. (ID 21 - 30)



- Mid-term actions will be prioritizing trail amenity projects, creating a technical team to review major projects (in addition to DRC) and conducting annual training to address safety, maintenance, design, etc. (ID 54 - 56)
- Long-term the plan calls for providing full-time staff dedicated to trails and bikeways with appropriate budgets. (ID 98)

### **Data Collection & Analysis**

- Ongoing Data Collection & Analysis actions include obtaining crash data and evaluating progress in reducing trail and bikeway injuries and fatalities. Also, monitoring response times for maintenance requests and an annual reporting of the type and number of requests being made. (ID 8 - 9)
- Short-term action items include performing evaluations of the bikeway facilities and compiling an inventory and prioritization of intersection and other enhancements that do not meet minimum design standards. Also, routinely conducting and updating bikeway and trail user counts to estimate usage levels and conducting before/after counts to gauge effectiveness of improvements. Also, keeping records of accidents and performing an annual review of the types reported to see if there are design or other changes that could lessen crashes. The plan calls for requesting the street sweeping data annually and establishing a database to track trends and provide data that could help refine street sweeping budgets and schedules. (ID 38 - 43)
- Mid-term actions will be developing a strategy to collect accident and injury data on trails and bikeways, conducting an annual user survey to collect and report mode-share data for all trips and periodically conducting community-wide public opinion surveys to determine how bicycling in Albuquerque could be improved. (ID 62 - 64)

### **Interagency Coordination**

- Ongoing Interagency Coordination actions include coordinating and partnering with other agencies' bike and trail programs as well as continuing to expand the interface between buses and bikes. They also include promoting bike/bus programs through ABQ Ride. (ID 10 - 11)
- Short-term action items include providing staff liaisons from departments of transportation (Counties, City, MRCOG, etc.) to attend Advisory Group meetings on a routine basis and developing a map or GIS tool that will improve interagency knowledge of emergency access and wayfinding information on trails. (ID 44 - 45)
- Mid-term actions are to work with the state universities to develop standards for a bicycle friendly transportation design and to develop and support a bike education program in elementary and secondary schools. Also, coordinate improvements and standards among city departments and other jurisdictions. (ID 65 - 67)

### **Maintenance**

- Ongoing Maintenance actions include establishing standards and schedules for inspection and maintenance activities and keeping an updated database and map. Also, ensuring that proper design guidelines are followed for trail maintenance and that re-seeding is done properly, along with mulching. Additionally, maintaining street surfaces on a routine basis to reduce hazards for cyclists.(ID 12 - 14)

- Short-term action items include establishing a 48-hour agency goal for responding to maintenance requests from citizens. Also, exploring alternative methods of treatment of puncture vine (goatheads) and, for major projects, requiring the design engineer to include a concept plan for the long-term maintenance that is envisioned. (ID 46 - 48)
- Mid-term actions are to implement the YARDI system, institutionalize a trail spot improvement program and determine the most effective way to prolong pavement life. Another action item calls for the City to consider adding another step to the 311 system that closes the loop after work is done. Trails should be swept regularly and procedures should be developed that will result in more frequent sweeping. The Parks Department should utilize G.O. bond funding to plan and implement a method for establishing native grass. Also, an annual update of the database of facilities maintenance responsibilities and considering how to address recurring issues. (ID 68 - 75)
- Long-term the plan calls for improving and funding the street maintenance and sweeping program to facilitate multi-use trail sweeping regularly and when requested. It also calls for maximizing the use of community service workers to help maintain the trails. Establishing native grasses and plants to squeeze out the puncture vines as well as a bottle deposit program will help keep the trails clean and safe.(ID 100 - 103)

## **Planning**

- Ongoing Planning actions include continuing to develop signage standards for trails and implementing wayfinding signage, completing a Bollard Replacement inventory and preserving/adding equestrian facilities where appropriate.(ID 15 - 17)
- Short-term action items include conducting an inventory of trails that do not meet minimum standards or have high ridership and retrofitting to current standards. This action item also includes using the ¼ cent Transportation Tax for trail rehab and modifying the DPM to reflect current standards for bicycle facilities and current best practices. In order to help prioritize funding, a list of the top bike/auto crashes should be compiled. (ID 49 - 54)
- Mid-term actions will be performing an audit of trails and developing an implementation plan for retrofitting, updating the Facilities Plan for Arroyos, evaluating the feasibility of a foundation that would allow tax-deductible contributions and development of a city-wide streetscape program. Additionally, the plan calls for amending the traffic code to help keep bike parking and trails free of motor vehicles, to include bicycle crashes in reporting and to include long-term bicycle permitting. Amending the DPM to update conflicting measuring standards and developing a new policy regarding exclusive use permits for trails events will also be done in the mid-term time frame. (ID 76 - 85)
- Long-term the plan calls for developing maps for the public that show appropriate trail types and identifying trails that are expected to have heavy commuter traffic. The plan also calls for amending the State Motor Vehicle Code to allow alternate methods for signaling turns on a bicycle. Additionally there should be a Pedestrian Safety and Infrastructure Plan as well as a Traffic Level of Stress Analysis. (ID 104, 107 - 112)

## **Programs**

- Ongoing Programs actions include developing an education and media campaign to promote bike etiquette and general awareness. Also, distributing an annual updated bike and trail map which includes tips and laws related to bicycling. (ID 18 - 20)
- Short-term action items include heightening public awareness of bicycle planning efforts and implementing launch parties when new facilities are completed. (ID 52 - 53)
- Mid-term actions will be promotion of bicycling, education on bicycling, development of incentive programs and encouraging bike related questions on driving license tests. Also, expanding and creating more family oriented bike programs such as Safe Rides to School and a Car Free Street Event and city-sponsored bike rack programs. (ID 86 - 96)
- Long-term the plan calls for connecting public outreach and education to law enforcement and developing a public campaign to encourage bicycle commuting. Also having a “One Stop” bicycling website and developing a Driver Diversion Class with the help of appropriate professionals. (ID 113 - 120)



**Table 10: Implementation Matrix**

Element	ID	Priority	Action	Measurement	Lead Agency; Coordination Required
CIP/Network Improvements	1	Ongoing	Develop new facilities to implement this Plan's goals of bikeways and trails as integral transportation infrastructure and recreational opportunities. Strive to increase on-street bikeway mileage from the current 365 to 500 by the year 2025 and 650 by the year 2035. Strive to increase trail mileage from the current 175 to 200 in the year 2025 and 240 in the year 2035.	Produce an annual report of the miles of trails and bikeways that have been completed.	<b>Municipal Development Parks &amp; Recreation; and Planning</b>
Administration	2	Ongoing	Work with citizen advisory and advocacy groups to promote bicycling and pedestrianism, improve bicycle and pedestrian safety, and improve the implementation of new facilities in their advisory role.	Attend at least one meeting of all advocacy groups that register with the City.	<b>Trails Coordinator &amp; Bikeways Coordinator; Planning</b>
Administration	3	Ongoing	Strongly encourage trail and bikeway dedication as part of other public project planning. Continue to support Land Development Regulations enabling trail and bikeway dedication and construction.		<b>Parks &amp; Recreation and Municipal Development; Planning</b>
Administration	4	Ongoing	Continue supporting programs related to education, outreach, and encouragement.		<b>Parks &amp; Recreation and Municipal Development; Planning</b>
Administration	5	Ongoing	Maintain a dedicated local funding source for construction, maintenance, and enhancement of trails and bikeways. Leverage local funding to obtain state and federal transportation funds for major projects that serve a transportation purpose. Invest in the development and promotion of connections among elements of the Parks, Open Space, and Trails (P.O.S.T.) system as well as a regional recreational trail system. DMD and P&R will communicate and coordinate requests for federal transportation funding and representation at MRCOG related to bikeways and trails.	Operating funds will be allocated for construction and maintenance	<b>Municipal Development and Parks &amp; Recreation</b>
Administration	6	Ongoing	Maintain a dedicated local funding source to support bikeway and trail programming and education efforts.	Operating funds will be allocated for programming and education	<b>Parks &amp; Recreation and Municipal Development; Planning</b>
CIP/Network Improvements	7	Ongoing	Evaluate the feasibility and suitability for non-motorized facilities on all new roads. Implement on-street bicycle facilities in conjunction with roadway rehab projects. Plan and design for bicycle travel with all intersection improvements, where feasible according to budget and schedule, to include 5-foot bike lanes or minimum curb lane widths of 15 feet through intersections.	Produce an annual report that documents the percent of new road projects/rehabs that include bicycle and/or pedestrian facilities.	<b>Municipal Development; Parks &amp; Recreation and Planning</b>
Data Collection & Analysis	8	Ongoing	Obtain crash data from the UNM Geospatial and Population Studies, Traffic Research Unit (TRU). Evaluate progress in reducing trail and bikeway fatalities and injuries.	Prepare an annual report that documents the status.	<b>MRCOG; Municipal Development</b>
Data Collection & Analysis	9	Ongoing	Monitor response time for the maintenance requests and provide follow-up on the type of response. Report annually the number and type of request being made.	Database is created and maintained	<b>Trails Coordinator &amp; Bikeways Coordinator; Planning</b>
Interagency Coordination	10	Ongoing	Coordinate with all of the many agencies and jurisdictions needed to implement the plan. Continue support of and partnership with other agencies' bike & trail programs as well as the MRCOG's regional Travel Reduction and Rideshare programs.	Prepare an annual report that documents the status of coordination efforts.	<b>Trails Coordinator &amp; Bikeways Coordinator; Planning</b>
Interagency Coordination	11	Ongoing	Continue and expand the interface between bikes and buses, including such features as bicycle racks on all buses, bicycle racks and lockers at park-and-ride lots, and the guaranteed ride home program. Promote bike/bus programs through ABQ Ride literature and PSAs.	Prepare an annual report that documents the status.	<b>Transit, Bikeway Coordinator, Trails Coordinator</b>
Maintenance	12	Ongoing	Establish maintenance standards <a href="#">that define a reasonable standard of care, as well as</a> a schedule for inspections and maintenance activities. Update the maintenance responsibility map and database.	Maintenance standards are adopted with this plan and implemented.	<b>Parks &amp; Recreation and Municipal Development</b>
Maintenance	13	Ongoing	Ensure that the Design Guidelines are followed for trail maintenance and that re-seeding and mulching is in compliance with best practices and safety needs of trail users. Practice selective weed control to reduce herbicide use and allow native grasses to establish.	Inventory the number and extent of facilities that are deficient in relation to the Design Guidelines	<b>Parks &amp; Recreation; Municipal Development and Planning</b>
Maintenance	14	Ongoing	Maintain arterial and collector street surfaces, including those not designated as bikeways, on a routine basis to reduce hazards (e.g., potholes, debris) for bicyclists who use these facilities.		<b>Municipal Development; Parks &amp; Recreation and Planning</b>
Planning	15	Ongoing	Continue to develop Signage Standards for trails. Implement City-wide on-street and trail wayfinding signage program as budget allows.	Signage Standards are developed	<b>Trails Coordinator; Municipal Development and Planning</b>

**Table 10: Implementation Matrix**

Element	ID	Priority	Action	Measurement	Lead Agency; Coordination Required
Planning	16	Ongoing	Bollard Placement evaluation & inventory. Complete the Bollard Inventory to identify the location and design of all existing bollards on trails. Prioritize remediation of bollard installations that do not meet the Design Standards in City right-of-way.		<b>Municipal Development and Parks &amp; Recreation; Planning</b>
Planning	17	Ongoing	Preserve and add equestrian facilities where appropriate.		<b>Parks &amp; Recreation; Municipal Development and Planning</b>
Programs	18	Ongoing	Develop a public information campaign regarding trail use safety. Educate the public about trail rules of etiquette and the types of accommodations required with high user volumes (slower speeds, more communication). Cooperate to inform the public on ditch and arroyo safety matters.	Document at least 1 informational campaign per year.	<b>Bicycle Safety Educator; Municipal Development and Planning</b>
Programs	19	Ongoing	Continue development and use of PSAs, as well as short instructional safety videos, to promote proper and legal bicyclist behavior. Promote general public awareness and acceptance of bicycling to promote bicycle safety. Encourage and support head injury awareness and helmet usage through awareness of state laws, educational brochures, and programs. Target use of PSAs on television/local radio stations for specific community events, especially during the annual Bike Month.	Document at least 1 informational campaign per year.	<b>Municipal Development and Bicycle Safety Educator; and Planning</b>
Programs	20	Ongoing	Develop, distribute, and update annually a bicycle and trail map, which includes commuting, and safety tips and laws related to bicycling.	A new map will be produced each year	<b>Bikeways Coordinator; Parks &amp; Recreation and Planning</b>
Administration	21	Short-term	Update the short-term priority facility construction list <a href="#">and map</a> every two years, in conjunction with the Decade Plan. Work with Citizen Advisory Groups to identify infrastructure priorities <a href="#">and consult the 2012 League of American Bicyclist recommendations for Albuquerque.</a>		<b>Trails Coordinator &amp; Bikeways Coordinator; Planning</b>
Administration	22	Short-term	Monitor the implementation of elements within the Bikeways and Trails Facility Plan and have a goal to update the Plan at <del>five</del> <b>four</b> year intervals. Monitor and document the status of work towards short and mid-term implementation actions. Evaluate if there is an adequate system and equitable distribution of each of the facility types, according to the principals of developing an extensive system that also responds to population densities and demand.	Produce an annual report with all projects and programs stasured.	<b>Planning, Municipal Development and Parks &amp; Recreation</b>
Administration	23	Short-term	Develop an improved project identification, design, and development process through a Plan Implementation Project Team & <a href="#">Technical Review Group Staff Coordination Committee, in conjunction with Citizen Advisory Group(s).</a>	Project implementation team is established and operational	<b>Parks &amp; Recreation and Municipal Development; Planning</b>
Administration	24	Short-term	Ensure that consistent, routine training of City of Albuquerque, MRCOG, and other jurisdiction staff is taking place.		<b>Parks &amp; Recreation and Municipal Development; Planning</b>
Administration	25	Short-term	Evaluate the current Advisory Group process and its effectiveness. Make recommendations and implement an improved training, coordination, and input process.		<b>Parks &amp; Recreation and Municipal Development; Planning</b>
Administration	26	Short-term	Conduct a biennial meeting among agencies involved in planning and implementation issues regarding bikeways and trails (construction, right of way, maintenance, funding, education, etc.) to include at least: the City (DMD, P&R, Planning Department, Open Space, Park Management, Bike Safety Program), NMDOT, BernCo, AMAFCA, MRCOG, MRGCD, Rio Rancho, and representatives of Citizens Advisory Groups and other advocacy groups. Topics will include: presentation of status reports regarding funding and programming, new facilities, new standards, and how to resolve recurring issues. A summary of the meeting and outcomes will be transmitted to participants and the Mayor and City Council and be posted on the City's website.	Meeting is conducted	<b>Trails Coordinator &amp; Bikeways Coordinator; Planning</b>
Administration	27	Short-term	<del>Adopt a Complete Streets Ordinance. In conjunction with citizen advisory groups, work towards implementation of the 2012 League of American Bicyclist recommendations for Albuquerque, or as updated, including development of appropriate and achievable performance measures related to bikeways and trails.</del>		<b>Parks &amp; Recreation and Municipal Development; Planning</b>
<a href="#">Administration</a>	<a href="#">28</a>	<a href="#">Short-term</a>	<a href="#">Complete annual ADA Transition Plans, which will guide the City towards identifying and correcting ADA issues along bikeways &amp; trails.</a>	<a href="#">Copy of the ADA Transition Plan is reviewed; project recommendations are considered.</a>	<a href="#">Parks &amp; Recreation and Municipal Development; Planning</a>

**Table 10: Implementation Matrix**

Element	ID	Priority	Action	Measurement	Lead Agency; Coordination Required
Administration	29	Short-term	Design & Construct facilities according to design standards/guidelines to improve safety of facilities. Adhere to the Design Guidelines adopted as part of this Plan when implementing projects unless strict adherence is not feasible. Any deviation must be documented by the project manager, including a rationale for the deviation.	Develop a documentation process to explain any design elements that are not consistent with the Design Guidelines.	<b>Parks &amp; Recreation and Municipal Development; Planning</b>
Administration	30	Short-term	Develop a City-wide policy for incorporating maintenance considerations and funding as part of all new (or major renovation) trail construction projects.	New policy has been implemented.	<b>Parks &amp; Recreation; Municipal Development and Planning</b>
Administration	31	Short-term	Design, construct, and maintain the proposed <b>Short-term High-Priority</b> projects in this Plan.		<b>Municipal Development and Parks &amp; Recreation</b>
CIP/Network Improvements	32	Short-term	Develop an implementation plan and work on completing the "Critical Link" Priorities that are identified in this plan by 2025 and identify other high priority gaps by 2035.	Produce an annual report of the gap closure projects that have been completed. Prioritized list of projects for next 2 years.	<b>Parks &amp; Recreation and Municipal Development; Planning</b>
CIP/Network Improvements	33	Short-term	Assess the need for and develop new facilities or routes as needed to support the Parks, Open Space, and Trails (POST) system. The facilities may include loop routes, secondary trails, primary trails, and other connecting facilities as needed to connect to desired destinations. Also assess the need for multi-use trails that contribute key linkages to the on-street bikeway system, including interim trail improvements where needed and spot safety trail improvements.	Document efforts to develop a prioritized list. Produce an annual report of the miles of trails that have been completed.	<b>Parks &amp; Recreation; Municipal Development and Planning</b>
Data Collection & Analysis	34	Short-term	Existing bicycle lanes should be inventoried to identify the number and location of intersections that do not provide a continuous bicycle facility.	Inventory is completed.	<b>Municipal Development; Planning</b>
Data Collection & Analysis	35	Short-term	The City should strive to identify the extent of bicycle lanes that are deficient in marked width, according to the current DPM standards and highlight these locations of deficiencies on the printed Bike Map.	Inventory is completed.	<b>Municipal Development; Planning</b>
CIP/Network Improvements	36	Short-term	Identify appropriate locations and implement innovative techniques to make the street system safe to provide critical connections in the trail and bikeway system. Provide appropriate educational campaigns before and after installation.	Implement at least one innovative technique at 2 locations per year.	<b>Bikeways Coordinator; Parks &amp; Recreation and Planning</b>
CIP/Network Improvements	37	Short-term	Utilize bicycle- and pedestrian-friendly roadway design practices and complete streets policies for all new and reconstructed roads <u>that are identified with proposed bikeway facilities</u> .	Monitor the number of new lane miles added and reconstructed roads with multi-modal facilities	<b>Municipal Development and Planning</b>
CIP/Network Improvements	38	Short-term	Provide striped lanes/shoulders of at least five feet wide on all new or reconstructed bridges, underpasses and overpasses.	Produce an annual report that documents the percent of new road projects/rehabs that include bicycle and/or pedestrian facilities.	<b>Municipal Development; Parks &amp; Recreation and Planning</b>
Data Collection & Analysis	39	Short-term	Perform an evaluation of the existing bikeway facilities according to the Infrastructure Project Evaluation Criteria identified in Chapter 4.A.1 Existing Bikeway Evaluation	A study is completed that identifies the quality of all existing bikeways and the substandard links are identified.	<b>Bikeways Coordinator; Parks &amp; Recreation and Planning</b>
Data Collection & Analysis	40	Short-term	Inventory and prioritize implementation of intersection enhancements, facility gap closures, and reconstruction of facilities that do not meet the minimum Design Standards. Utilize the database to identify high accident locations and/or high accident severity locations to help in the prioritization of project and program improvements.	Inventory and priority list is updated.	<b>Municipal Development; Parks &amp; Recreation and Planning</b>
Data Collection & Analysis	41	Short-term	Routinely conduct and update bikeway and trail user counts to estimate usage levels and to help determine progress toward achieving future mode-split goals and to document the proportion of male vs. female users.	Database is created and maintained	<b>MRCOG; Parks &amp; Recreation, Municipal Development and Planning</b>



**Table 10: Implementation Matrix**

Element	ID	Priority	Action	Measurement	Lead Agency; Coordination Required
Data Collection & Analysis	42	Short-term	Conduct before and after bicycle counts for road-ways that are reconstructed or re-stripped to have bicycle lanes and for other improvements to bike-ways to gauge the effect of the improvements.	Database is created and maintained	<b>MRCOG;</b> Municipal Development
Data Collection & Analysis	43	Short-term	Maintain and update a facility-user accident database. Perform an annual review of the types of incidents reported, and determine if there are design changes, location-specific improvements, or educational campaigns that could reduce the number of crashes and accidents. Review each collision/accident in a timely manner to identify system deficiencies and potential improvements. Consider using a Critical Incident Survey to collect self-reported accident and injury information.	Database is created and maintained	<b>Risk Management;</b> Planning, Municipal Development, and Parks & Recreation
Data Collection & Analysis	44	Short-term	Request the annual data on frequency of scheduled sweeping for the on-street bikeway and multi-use trail system, along with the number and location of spot sweeping requests. Establish a database to track trends and provide data that can be used refine scheduled sweeping and maintenance budget request.	Database is created and maintained	<b>Bikeways Coordinator and Trails Coordinator;</b> and Planning
Interagency Coordination	45	Short-term	Provide staff liaisons from the City, MRCOG, Bernalillo and Sandoval Counties, and other area departments of transportation to attend Advisory Group meetings and to work on Advisory Group issues on a routine basis.		<b>Trails Coordinator, Bikeways Coordinator and Other Agencies</b>
Interagency Coordination	46	Short-term	Develop a map or GIS tool that will improve interagency knowledge of emergency access location and wayfinding information on trails.	Prepare an annual report that documents the status.	<b>Trails Coordinator; APD &amp; other First-Responders</b>
Maintenance	47	Short-term	Establish timely responsiveness to maintenance requests from citizens through the use of the City's 311 Citizen Contact Center or website or other means for citizens to report concerns. Establish an agency goal of 48 hours to address these requests.	Monitor response time for the maintenance requests and provide follow-up on the type of response. Report annually the number and type of request being made.	<b>Municipal Development and Parks &amp; Recreation;</b> Planning
Maintenance	48	Short-term	Explore alternative methods of treatment of puncture vine, such as: various methods of mechanical removal; various methods of establishing native grass without using supplemental irrigation; alternative approaches to herbicide practices, with careful attention to application/timing; and biological techniques (weevils).	Study is completed	<b>Parks &amp; Recreation;</b> Municipal Development and Planning
Maintenance	49	Short-term	For major trail projects, require the design engineer to include a concept plan for the long-term maintenance protocol that is envisioned, e.g. care of plantings, drainage issues, etc.	Standard language about maintenance is included in engineering Scope of Work	<b>Parks &amp; Recreation;</b> Municipal Development and Planning
Planning	50	Short-term	Inventory, evaluate, and then retrofit design enhancements for facilities that do not meet the minimum standards or have a high number of users.		<b>Municipal Development and Parks &amp; Recreation;</b> Planning
Planning	51	Short-term	<del>Apply 1/4 Transportation Tax funding for a trail rehabilitation project, using a City contractor to implement the outcomes of the evaluation.</del> <u>GARTC should investigate how to understand, measure, count, and encourage recreational trail use. GARTC should make recommendations on the need for and approach to data collection about the recreational trail experience.</u>	Rehabilitation and evaluation are complete	<b>Trails Coordinator;</b> Bikeways Coordinator and Planning
Planning	52	Short-term	Modify the DPM to <u>reflect current standards for bicycle facilities and to reflect current best practices, such as it should</u> require developers of walled subdivisions to provide connectivity between their developments and adjacent bikeways and trails.	Standards have been amended.	<b>Planning;</b> Municipal Development
Programs	53	Short-term	Heighten public awareness of bicycle planning efforts and ensure on-going citizen participation and support for bikeway development. Provide periodic news releases for bicycle planning and bicycle system development.	Document the number of informational campaigns per year	<b>Municipal Development;</b> Parks & Recreation and Planning
Programs	54	Short-term	Implement Launch Parties for New Bikeways when new facilities are completed. It is a low-cost strategy that publicizes new facilities and builds public awareness of bicycling. As a low-cost/high-benefit program, it should become part of the City's standard bikeway implementation procedure.	Document efforts to expand the program.	<b>Trails Coordinator and Bikeways Coordinator;</b> Planning
Planning	55	Short-term	<u>Compile a list of top Bicycle / Vehicle crash locations city-wide to help prioritize funding and efforts.</u>	<u>Top crash locations are identified</u>	<b>Municipal Development and Parks &amp; Recreation;</b> Planning

**Table 10: Implementation Matrix**

Element	ID	Priority	Action	Measurement	Lead Agency; Coordination Required
Administration	55	Mid-term	Prioritize implementation of trail amenities projects. Obtain supplemental capital funding as needed for major projects and to provide trail amenities.	Trail amenity locations are prioritized.	<b>Parks &amp; Recreation</b>
Administration	56	Mid-term	Create a <del>Technical Review Committee (TRC)</del> <u>Staff Coordination Committee (SCC)</u> to include a few key staff members with expertise in design of trail and bike facilities. TRC would review major projects on a project-by-project basis. This review would be in addition to and in anticipation of DRC. Other experts would be included on a case-by case basis as necessary, e.g., ADA specialist, Traffic Engineer, Park Management, AMAFCA, etc. Where there are potentially difficult design issues, a pre-design meeting of the TRC would be appropriate and input from Citizen Advisory Groups will be sought. TRC's recommendations will be documented by the Project Manager.	TRC is established and this approach is implemented.	<b>Trails Coordinator &amp; Bikeways Coordinator; Planning</b>
Administration	57	Mid-term	Conduct an annual training to address the following groups and topics: 1) engineers, landscape architects, and others involved in path design, including both in-house and non-City professionals, regarding shared use path design issues and innovations; 2) traffic safety personnel, regarding on-street bikeway design and techniques regarding paths crossings of arterials; and 3) maintenance staff, regarding status, issues and techniques in maintenance practices. Materials will be posted on the City's website.	Annual training program is developed and implemented.	<b>Trails Coordinator &amp; Bikeways Coordinator; Planning</b>
CIP/Network Improvements	58	Mid-term	Develop strategies and use design techniques on available right-of-way to minimize conflict of use on all high use trail corridors.	Reduced number of trail crashes is documented	<b>Trails Coordinator; Municipal Development and Planning</b>
CIP/Network Improvements	59	Mid-term	Evaluate all collector and arterial roadways for the possibility of restriping to provide bike lanes, or minimum out-side lane width of 14 feet.	All major roadways are evaluated.	<b>Municipal Development</b>
CIP/Network Improvements	60	Mid-term	Prioritize system enhancements for bicycle lanes with unclear travel paths through major intersections. Install Multi-Lane Arterial Intersection Improvements, including continuous bicycle lane markings up to the crosswalk, bicycle detection loop, and color enriched bicycle travel lane in conflict areas according to the adopted "Prototypical Intersection Improvement" design in this plan. Include these improvements as a portion of each annual capital improvements budget.	Document efforts to develop a prioritized list.	<b>Bikeways Coordinator; Parks &amp; Recreation and Planning</b>
CIP/Network Improvements	61	Mid-term	Determine and prioritize appropriate locations for major improvements, such as overpass structures.	Document efforts to develop a prioritized list.	<b>Municipal Development and Parks &amp; Recreation</b>
CIP/Network Improvements	62	Mid-term	Develop a strategy for including publically accessible trails and bikeways in all new subdivisions to create a network with at least one facility every half-mile.	Document efforts to develop a program.	<b>Planning; Municipal Development and Parks &amp; Recreation</b>
Data Collection & Analysis	63	Mid-term	Develop a strategy and program to collect accident and injury data on trails and bikeways. Consider using a Critical Incident Survey to collect self-reported accident and injury information.	Study is completed	<b>Trails Coordinator &amp; Bikeways Coordinator; Planning</b>
Data Collection & Analysis	64	Mid-term	Conduct an annual bicycle user survey to collect and report mode-share data for commuting trips and all trips taken.	Survey is created and administered	<b>Bikeways Coordinator &amp; Trails Coordinator; Planning</b>
Data Collection & Analysis	65	Mid-term	Periodically conduct community-wide public opinion surveys to: 1) determine reasons why people do or do not ride bicycles, 2) develop bicycle trip patterns and purposes, and 3) gain input on bicycle projects and programs that could improve bicycling in Albuquerque.	Survey is created and administered	<b>Bikeways Coordinator &amp; Bicycle Educator; Planning</b>
Interagency Coordination	66	Mid-term	Work with the University of New Mexico and New Mexico State University to develop curricula for bicycle-friendly transportation system design.	Prepare an annual report that documents the status.	<b>Bikeway Coordinator; UNM</b>
Interagency Coordination	67	Mid-term	Develop and fully support a bicycle education program in Albuquerque's elementary and secondary schools as part of current physical education requirements.	Prepare an annual report that documents the status.	<b>APS; Bicycle Educator</b>
Interagency Coordination	68	Mid-term	Coordinate improvements and standards among City Departments, applicable public agencies, and other jurisdictions, including, but not limited to AMAFCA, NMDOT, Bernalillo County, Rio Rancho, Sandoval County, Corrales, Los Ranchos, KAFB.	Adoption of consistent design and maintenance standards across jurisdictions	<b>Bikeway Coordinator; Trails Coordinator</b>
Maintenance	69	Mid-term	Implement the YARDI system and apply it to the trails network to keep track of maintenance needs.	All maintenance activities are documented in YARDI	<b>Parks &amp; Recreation</b>

**Table 10: Implementation Matrix**

Element	ID	Priority	Action	Measurement	Lead Agency; Coordination Required
Maintenance	69	Mid-term	The City should explore adding another step to the 311 notification system that closes the loop after the work order is completed.	The 311 notification system is modified	<b>311;</b> Parks & Recreation and Municipal Dev.
Maintenance	70	Mid-term	Institutionalize a trail spot improvement program.	Spot improvement program is implemented for trail repair	<b>Trails Coordinator;</b> Municipal Development and Planning
Maintenance	71	Mid-term	Determine the most effective methodology for extending pavement life and explore sharing responsibility for addressing these issues (regarding equipment, expertise, etc.).	Study is completed	<b>Trails Coordinator &amp; Bikeways Coordinator</b>
Maintenance	72	Mid-term	Trails should be swept on a scheduled basis and when requested. Locations that historically require more frequent sweeping should be noted and investigated as to what may be causing this problem and fix if practical.	Monitor the number of maintenance requests	<b>Parks &amp; Recreation;</b> Municipal Development and Planning
Maintenance	73	Mid-term	Based on results and experience of investigations on methods for establishment of native grass, Park Management should utilize G.O. bond funding and 1/4 cent Transportation Tax to plan and implement a program to establish. This may take a sequence of years.	Revegetation program is implemented	<b>Parks &amp; Recreation</b>
Maintenance	74	Mid-term	Develop procedures to more frequently sweep and maintain streets that have on-street bicycle facilities	Sweep schedule is created	<b>Municipal Development;</b> Planning
Maintenance	75	Mid-term	P&R and DMD will annually update the database of facilities maintenance responsibilities and consider how to address recurring issues/complaints.	Annual maintenance actions are documented	<b>Parks &amp; Recreation and Municipal Development;</b> Planning
Planning	76	Mid-term	Perform an ADA audit of all trails and develop an implementation plan to retrofit trails to be universally accessible where feasible.	Document efforts to develop a prioritized list.	<b>Trails Coordinator;</b> Bikeways Coordinator and Planning
Planning	77	Mid-term	Facilities Plan for Arroyos Update	Plan is updated	<b>Parks &amp; Recreation and Planning</b>
Planning	78	Mid-term	Development of a City-wide Streetscape Plan w/Maintenance Element	Study is complete	<b>Solid Waste;</b> Municipal Development and Planning
Planning	79	Mid-term	Evaluate the feasibility of a Parks, Open Space & Trails Foundation, which would allow tax-deductible contributions and encourage patronship	Parks, Open Space, and Trails Foundation is established	<b>Parks &amp; Recreation;</b> Municipal Development and Planning
Planning	80	Mid-term	Develop a new policy regarding Exclusive Use Permit for Trails Events	New policy is adopted	<b>Open Space and Cultural Services;</b> Municipal Development and Planning
Planning	81	Mid-term	Identify and evaluate how to address needed ADA non-compliance, repairs, replacements, and frequently required problem areas (sweeping, pavement drop-offs, erosion, etc.).	Study(s) are complete	<b>Trails Coordinator;</b> Bikeways Coordinator and Planning
Planning	82	Mid-term	Amend the Albuquerque Traffic Code, §8-5-1-1, to prohibit parking in a marked bicycle lane or bicycle box, and §8-5-1-15, to clearly identify that bicycle lanes are travel lanes	Regulation is amended	<b>City Council;</b> Planning
Planning	83	Mid-term	Amend the Albuquerque Traffic Code, §8-2-9-1 and 8-2-9-2 Accidents, Reports, to include reporting of bicycle crashes.	Regulation is amended	<b>City Council;</b> Planning
Planning	84	Mid-term	Amend the Albuquerque Parking Code, §14-16-3-1, to include long-term bicycle parking, where applicable.	Regulation is amended	<b>City Council;</b> Planning
Planning	85	Mid-term	Amend the Development Process Manual to indicate the correct way of measuring the width of bicycle lanes to make the text match the diagram	Manual is amended	<b>Planning,</b> Municipal Development and Parks & Recreation



**Table 10: Implementation Matrix**

Element	ID	Priority	Action	Measurement	Lead Agency; Coordination Required
Programs	86	Mid-term	Law Enforcement Education trainings and Community Enforcement Actions (such as targeted speed enforcement near schools, speed reader board deployment, bicycle light giveaways, etc.).	Education and Enforcement programs are developed & implemented.	<b>Bikeways Coordinator;</b> APD and Planning
Programs	87	Mid-term	Promote Albuquerque as a Bicycle-Friendly Community by achieving the League of American Bicyclists' Bicycle Friendly Communities award designation and Bicycling Magazine's Top Ten Best Cities for Cycling award. Apply to become a silver-level Bicycle Friendly Community.	Report the results of the survey. Identify solutions to rectify deficiencies reported by the award.	<b>Bikeways Coordinator;</b> Planning
Programs	88	Mid-term	Utilize volunteers and the citizen advisory committees to the greatest extent possible to implement the policies in the plan. Develop a program to utilize volunteers for safety patrols.	Document efforts to develop a program.	<b>Trails Coordinator and Bikeways Coordinator;</b> Planning
Programs	89	Mid-term	Promote air quality benefits of bicycling through public outreach efforts to major public and private sector employers, such as the University of New Mexico (UNM), KAFB, Sandia National Laboratories, Intel, and area schools.	Document efforts to develop a program.	<b>Environmental Health and Planning</b>
Programs	90	Mid-term	Develop, implement, and promote specific incentive programs to encourage existing businesses and other entities to provide facilities for bicycling, such as bicycle racks, bicycle lockers, changing areas, showers, and clothes lockers. Develop and support cash incentive programs to promote bicycling, such as parking cash-out allowances (i.e., cash payments to bicyclists in lieu of employer-provided parking) for City, UNM, KAFB, and other employees who work for public or private sector employers.	Document efforts to develop a program.	<b>Bikeways Coordinator;</b> Economic Development and Planning
Programs	91	Mid-term	Promote organized bicycle events and racing on city streets as a means of increasing public awareness of bicycling as a viable sport for public viewing and participation.	Document efforts to develop a program.	<b>Bikeways Coordinator and Planning</b>
Programs	92	Mid-term	Encourage the inclusion of bicycling-related questions in motor vehicle driving license tests as a means to raise awareness of bicyclists' rights and responsibilities.	Document efforts to develop a program.	<b>APD;</b> Bicycle Educator, Municipal Development and Planning
Programs	93	Mid-term	Expanding the existing Albuquerque Safe Routes to School program will offer great benefits to children's health and safety. The statewide Safe Routes to School program, run by the New Mexico Department of Transportation, offers funding assistance for developing an action plan, implementing infrastructure projects and offering non-infrastructure projects.	Document efforts to expand the program.	<b>Bicycle Educator and Bikeways Coordinator;</b> Planning
Programs	94	Mid-term	Several family-oriented outreach programs have been recommended, including a Family Bicycling and Trail Use Program, a Bike to Parks Program and a Summer Streets Car-Free Street Event. These all should be seen as medium-priority actions and the City should select which program they would like to focus on first. A Share the Trail Campaign is not a first-tier priority, but may be implemented sooner if a community group like BikeABQ is willing to take primary responsibility for it.	Document efforts to expand the program.	<b>Trails Coordinator and Bikeways Coordinator;</b> Planning
CIP/Network Improvements	95	Mid-term	Prioritize, design, construct, and maintain the proposed intersection improvements and the proposed grade separated crossings & mid-block crossings		<b>Municipal Development;</b> Parks & Recreation and Planning
Programs	96	Mid-term	Driver Education Related to Bicycling		<b>Municipal Development;</b> Parks & Recreation and Planning
Programs	97	Mid-term	City-Sponsored Bike Rack Program		<b>Municipal Development;</b> Parks & Recreation and Planning
Administration	98	Long-term	Provide full-time staff positions dedicated to trails and bikeways with appropriate office budgets to promote bicycling and trail use within Albuquerque.	Report of the number of staff who are dedicated to bikeways & trails	<b>Municipal Development;</b> Parks & Recreation and Planning
CIP/Network Improvements	99	Long-term	Provide a striped bicycle lane or shoulder consistent with the City's Development Process Manual and AASHTO bicycle facility design guidelines on all new, rehabilitated or reconstructed roadways, as indicated in the Facility Plan.		<b>Municipal Development;</b> Planning

**Table 10: Implementation Matrix**

Element	ID	Priority	Action	Measurement	Lead Agency; Coordination Required
Maintenance	100	Long-term	Improve and fund the street maintenance and sweeping program. Establish the highest priority for allocation of street sweeping resources to sweeping all bike lanes at least once per month and bike routes on local streets a minimum of four times a year. Multi-use trail sweeping should be performed on a regular basis and when requested.	Request the annual data on frequency of scheduled sweeping for the on-street bikeway and multi-use trail system, along with the number and location of spot sweeping requests. Establish a database to track trends and provide data that can be used to refine scheduled sweeping and maintenance budget request.	<b>Municipal Development;</b> Parks & Recreation and Planning
Maintenance	101	Long-term	Maximize use of community service workers program to enhance Park Management’s ability to address trail maintenance.	Parks and Recreation has implemented a community service work program	<b>Trails Coordinator;</b> Municipal Development and Planning
Maintenance	102	Long-term	Establish native drought-tolerant grasses and plants next to trails, with a goal that over time, the natives will out-compete the puncture vine.	Monitor the number of complaints about puncture vine problems	<b>Trails Coordinator;</b> Municipal Development and Planning
Maintenance	103	Long-term	Encourage a bottle deposit program in order to reduce littering of roadways and bike facilities with broken glass.		<b>Municipal Development,</b> <b>Solid Waste and City</b> <b>Council</b>
Planning	104	Long-term	Develop maps for use by the public that show which portions of the trail system are appropriate for particular types of trail users and that highlight major destinations.	A new series of maps is produced and distributed	<b>Trails Coordinator;</b> Municipal Development and Planning
CIP/Network Improvements	105	Long-term	Assess the system's ability to provide connectivity for different user type. Evaluate the extent of system for each user type.	Different maps are produced that reflect facilities suitable for different user groups	<b>Planning;</b> Municipal Development and Parks & Recreation
CIP/Network Improvements	106	Long-term	Develop and implement a wayfinding & orientation program. Develop a standardized facility naming and marking program for trail wayfinding. Implement trail and bikeway signage and marking as recommended in the wayfinding program. Coordinate with emergency responders regarding the outcome of the trail way-finding system		<b>Trails Coordinator and</b> <b>Bikeways Coordinator;</b> Planning
Planning	107	Long-term	Amend the NM State Motor Vehicle Code, §66-7-327, to allow alternate methods for signaling turns on a bicycle	Regulation is amended	<b>Bikeways Coordinator;</b> Planning
Planning	108	Long-term	End of trip facilities & incentivization programs		<b>Municipal Development;</b> Parks & Recreation and Planning
Planning	109	Long-term	Identify trails which may expect heavy bicycle commuter traffic and require an extra design effort on those trails to separate user types depending on right-of-way and License Agreements.	Planning Study with User Survey	<b>Parks &amp; Recreation;</b> Municipal Development and Planning
Planning	110	Long-term	Pedestrian Safety & Infrastructure Plan	Plan is complete	<b>Planning;</b> Municipal Development
Planning	111	Long-term	MMLOS or Traffic Level of Stress Analysis	Study is complete	<b>Planning;</b> Municipal Development
Planning	112	Long-term	Perform a corridor analysis or specialized study where necessary to address environmental agency or neighborhood concerns, or to determine precise alignment for future trails and on-street bicycle facilities.	Study is complete	<b>Municipal Development</b> <b>and Parks &amp; Recreation;</b> Planning

**Table 10: Implementation Matrix**

Element	ID	Priority	Action	Measurement	Lead Agency; Coordination Required
Programs	113	Long-term	Develop and implement a consistent, balanced traffic law education program for law enforcement personnel for improving target pedestrian, bicyclist, and motorist compliance with traffic laws. Update or develop materials for use by law enforcement personnel to support education and enforcement efforts.	Document efforts to develop a program.	<b>APD;</b> Bicycle Educator, Municipal Development and Planning
Programs	114	Long-term	Develop and implement a traffic law enforcement program for bicyclists and motorists and link to education program efforts. Increase public outreach efforts, including video and audio PSAs to educate motorists on bicyclists' rights and responsibilities.	Document efforts to develop a program.	<b>APD;</b> Bicycle Educator, Municipal Development and Planning
Programs	115	Long-term	Develop a public information campaign to encourage bicycle commuting. Work with businesses throughout the Albuquerque to encourage commuting by bicycle among their employees and to increase motorists' awareness to share the road. Provide outreach and personal travel cost information that shows how bicycle transportation can be beneficial to both employees and students.	Document at least 1 informational campaign per year.	<b>Bikeways Coordinator;</b> Parks & Recreation and Planning
Programs	116	Long-term	Commit appropriate police time (bicycle and motor vehicle patrols) to target pedestrian, bicyclist, and motorist enforcement efforts.	Document strategies for balanced enforcement efforts.	<b>APD</b>
Programs	117	Long-term	Continue and expand Police Bicycle Patrols and dedicate a distinct percentage of their time to educational efforts on proper bicycling behavior.	Report the number of staff or FTE assigned to bicycle patrols.	<b>APD</b>
Programs	118	Long-term	Provide dedicated funding to support public bicycling awareness programs and "Share the Road" campaigns.	Operating funds will be allocated for bicycling awareness programs	<b>Bicycle Educator and Municipal Development;</b> Planning
Programs	119	Long-term	Developing a Driver Diversion Class will be a longer-term effort, as they will require coordination with many community partners. The Diversion Class will require the support and participation of local courts, and work-ing with lawyers, traffic safety professionals and educators to prepare the curriculum will help the program launch on a firm footing. This program may need start-up funding to develop the course, but it should be self-sustaining on a long-term basis as the fee for participation can be set to cover the costs of the program.	Document efforts to develop a program.	<b>APD;</b> Parks & Recreation, Municipal Development and Planning
Programs	120	Long-term	"One-Stop" Albuquerque Bicycling Website. It can be hosted on the City's existing website, incurring no additional expenses, and can largely be assembled by City staff, with the support and participation of GABAC and GARTC.	Document efforts to develop a program.	<b>ITSD Coordinator;</b> Planning



# CHAPTER 7: DESIGN MANUAL

## Contents

<b>CHAPTER 7: DESIGN MANUAL</b> .....	<b>171</b>
A. GUIDING DOCUMENTS .....	171
B. ON-STREET FACILITIES.....	175
C. TRAIL DESIGN .....	206
D. GENERAL INTERSECTION DESIGN GUIDELINES.....	264
E. WAYFINDING .....	277
F. MAINTENANCE & OPERATIONS.....	284

### A. Guiding Documents

The City of Albuquerque has been working to implement on- and off-street projects to encourage walking and cycling, ~~to improve safety~~ ~~the user experience,~~ ~~and to improve~~ accessibility, and ~~to~~ enhance the quality of the walkway and bikeway networks so that these activities become integral parts of daily life. While Albuquerque is growing, it has a predominantly built urban environment, and many future projects will involve retrofitting existing streets and intersections. The City has a moderate demand for on-street parking, an auto-oriented roadway system reliant on high-capacity arterials and many other complex situations. When looking to implement sidewalks and bike lanes or other improvements on City streets, most standard design manuals offer limited solutions.

The Albuquerque Bikeways and Trails ~~Master Facility~~ Plan ~~Update~~ Design Guidelines are designed to provide an extensive range of design options for bikeways and trail treatments. These design concepts are based on current bikeway and trail design guidelines for typical situations provided in City documents, including:

- City of Albuquerque *Development Process Manual* (DPM)
- City of Albuquerque *Trails & Bikeways Plan*, 2000
- City of Albuquerque *Comprehensive On-Street Bicycle Plan*, 1993

In addition, the Association of State Highway and Transportation Officials (AASHTO) 2000 Guide for the Development of Bicycle Facilities and the Manual of Uniform Traffic Control Devices (MUTCD) 2003, Part 9 Traffic Controls for Bicycle Facilities and 2009 update were also used. The Albuquerque Bikeways and Trails ~~Master Facility~~ Plan ~~Update~~ Design ~~Guidelines~~ ~~Manual~~ uses these documents as a baseline for minimum conditions. In addition to the current standards, an innovative design treatments section follows the design guidelines and provides creative solutions that have been used nationally and internationally to provide ~~safe~~ ~~improved~~ bikeways that are appealing to a wide range of users.

The following are key principles for these pedestrian and bicycle guidelines:

- The bicycling and trail environment should ~~be safe~~ make users feel at ease. Bike routes, pathways, and crossings should be designed and built to be free of hazards and to minimize conflicts with external factors such as noise, vehicular traffic and protruding architectural elements.
- The bikeway and trail network should be as accessible as possible. Bike routes, pathways, and crosswalks should ensure the mobility of all users by accommodating the needs of people regardless of age or ability. Bicyclists have a range of skill levels, and facilities should be designed for use by experienced cyclists at a minimum, with a goal of providing for inexperienced/recreational bicyclists (especially children and seniors) to the greatest extent possible. In areas where specific needs have been identified (e.g., near schools) the needs of appropriate types of bicyclists should be accommodated.
- The bikeway and trail network should connect to places people want to go. The bikeway and trail network should provide continuous direct routes and convenient connections between destinations, including homes, schools, shopping areas, public services, recreational opportunities and transit.
- The bicycling and trail environment should be easy to use. Bike routes, pathways, and crossings should be designed so people can easily find a direct route to a destination and delays are minimized. Most roads in Albuquerque are legal for the use of bicyclists, meaning that most streets are bikeway facilities and should be designed, marked, and maintained accordingly.
- The bikeway and trail environment should create good places. Good design should enhance the feel of the bicycle and trail environment. A complete network of on-street bikeway facilities should connect seamlessly to the existing and proposed off-street pathways to complete recreational and commuting routes around the city.
- Bikeway and trail improvements should be economical. Improvements should be designed to achieve the maximum benefit for their cost, including initial cost and maintenance cost as well as reduced reliance on more expensive modes of transportation. Where possible, improvements in the right-of-way should stimulate, reinforce, and connect with adjacent private improvements.

Design guidelines are intended to be flexible and can be applied with professional judgment by designers. Specific national and state guidelines are identified in this document, as well as design treatments that may exceed these guidelines.

## **1. National and State Guidelines/Best Practices**

The following is a list of references and sources used to develop design guidelines for the Albuquerque Bikeways and Trails ~~Master Facility~~ Plan ~~Update~~-Design Guidelines. Many of these documents are available online and are a wealth of information and resources that are available to the public.

In the evaluation of facilities, it should be considered whether the AASHTO or NACTO standards are more appropriate when there is conflict between the two guiding documents. When it comes to bikeways and trails in the developed urban portions of the city, the NACTO Urban Bikeway Design

Guide shall be the governing document in the event of conflict with the AASHTO document, unless the project funding stipulates otherwise. There should be documentation of which standards were selected and why.

## 2. Federal Guidelines

- [Urban Bikeway Design Guide. 2014. National Association of City Transportation Officials \(NACTO\).](#)
- AASHTO *Guide for the Development of Bicycle Facilities*, 1999/2012. American Association of State Highway and Transportation Officials, Washington, D.C. [www.transportation.org](http://www.transportation.org)
- AASHTO *Policy on Geometric Design of Streets and Highways*, 2001. American Association of State Highway and Transportation Officials, Washington, D.C. [www.transportation.org](http://www.transportation.org)
- *Manual on Uniform Traffic Control Devices (MUTCD)*, 2003. Federal Highway Administration, Washington, D.C. <http://mutcd.fhwa.dot.gov>
- [Public Rights-of-Way Accessibility Guidelines \(PROWAG\)](#), 2007. United States Access Board, Washington, D.C. <http://www.access-board.gov/PROWAC/alterations/guide.htm>
- [ADA Final Guidelines for Outdoor Developed Areas, 2013. United States Access Board, Washington D.C.](#)
- *Regulatory Negotiation Committee on Accessibility Guidelines for Outdoor Developed Areas Final Report*, 1999, U.S. Access Board. <http://www.access-board.gov/outdoor/outdoor-rec-rpt.htm>

## 3. State and Local Guidelines

- City of Albuquerque *Development Process Manual*. [www.cabq.gov/planning/dpm/dpm.html](http://www.cabq.gov/planning/dpm/dpm.html)
- Albuquerque Municipal Development Department, *Neighborhood Traffic Management Standards*.
- New Mexico Department of Transportation, *New Mexico Bicycle-Pedestrian-Equestrian Advisory Plan*, 2009.
- New Mexico *Comprehensive Transportation Safety Plan (CTSP)*, 2009.  
[www.nmshtd.state.nm.us/upload/images/Traffic\\_Safety/pdf/DR3\\_NMDOT\\_Safety%20Plan%20Strategie\\_COMPLETE.pdf](http://www.nmshtd.state.nm.us/upload/images/Traffic_Safety/pdf/DR3_NMDOT_Safety%20Plan%20Strategie_COMPLETE.pdf)
- New Mexico. (1978). *Night Sky Protection Act*. (Section 74-12-11 NMSA 1978)  
[www.law.justia.com/newmexico/codes/nmrc/jd\\_74-12-3-1b725.html](http://www.law.justia.com/newmexico/codes/nmrc/jd_74-12-3-1b725.html)

## Best Practices Documents

- FHWA Report HRT-04-100, *Safety Effects of Marked Versus Unmarked Crosswalks at Uncontrolled Locations*. [www.tfhr.gov/safety/pubs/04100/](http://www.tfhr.gov/safety/pubs/04100/)
- FHWA. (2001). *Designing Sidewalks and Trails for Access*  
[www.fhwa.dot.gov/environment/sidewalk2/contents.htm](http://www.fhwa.dot.gov/environment/sidewalk2/contents.htm)
- *Road Diet Handbook: Setting Trends for Livable Streets*. 2006. Jennifer Rosales.
- *Bicycle Facility Selection: A Comparison of Approaches*. Michael King, for the Pedestrian and Bicycle Information Center. Highway Safety Research Center, University of North Carolina – Chapel Hill, August 2002. [www.bicyclinginfo.org/pdf/bikeguide.pdf](http://www.bicyclinginfo.org/pdf/bikeguide.pdf)



- [APBP Bicycle Parking Guidelines.](http://c.ymcdn.com/sites/www.apbp.org/resource/resmgr/publications/bicycle_parking_guidelines.pdf)  
[http://c.ymcdn.com/sites/www.apbp.org/resource/resmgr/publications/bicycle\\_parking\\_guidelines.pdf](http://c.ymcdn.com/sites/www.apbp.org/resource/resmgr/publications/bicycle_parking_guidelines.pdf)
- *Bicycle Parking Design Guidelines.* [www.bicyclinginfo.org/pdf/bikepark.pdf](http://www.bicyclinginfo.org/pdf/bikepark.pdf)
- *City of Chicago Bike Lane Design Guide.* [www.bicyclinginfo.org/pdf/bike\\_lane.pdf](http://www.bicyclinginfo.org/pdf/bike_lane.pdf)
- *The North Carolina Bicycle Facilities Planning and Design Guidelines*, 1994. NCDOT Division of Bicycle and Pedestrian Transportation.  
[www.ncdot.org/transit/bicycle/projects/resources/projects\\_facilitydesign.html](http://www.ncdot.org/transit/bicycle/projects/resources/projects_facilitydesign.html)
- *Wisconsin Bicycle Facility Design Handbook.* 2004. Wisconsin Department of Transportation.  
[www.dot.wisconsin.gov/projects/bike.htm](http://www.dot.wisconsin.gov/projects/bike.htm)
- *Florida Bicycle Facilities Planning and Design Handbook.* 1999. Florida Department of Transportation.  
[www.dot.state.fl.us/safety/ped\\_bike/ped\\_bike\\_standards.htm#Florida%20Bike%20Handbook](http://www.dot.state.fl.us/safety/ped_bike/ped_bike_standards.htm#Florida%20Bike%20Handbook)
- *Oregon Bicycle and Pedestrian Plan.* 1995 Oregon Department of Transportation.  
[www.oregon.gov/ODOT/HWY/BIKEPED/planproc.shtml](http://www.oregon.gov/ODOT/HWY/BIKEPED/planproc.shtml)
- *City of Portland (OR) Bicycle Master Plan.* 1998. City of Portland (OR) Office of Transportation.  
[www.portlandonline.com/shared/cfm/image.cfm?id=40414](http://www.portlandonline.com/shared/cfm/image.cfm?id=40414)
- *Vélo Québec.* 2003. Technical Handbook of Bikeway Design.
- ~~*Urban Bikeway Design Guide.* 2014. National Association of City Transportation Officials (NACTO).~~
- *Sign Up for the Bike: Design Manual for a Cycle Friendly Infrastructure (CROW).* 2006. Record 25: Design Manual for Bicycle Traffic. CROW, The Netherlands.
- *Trail Solutions: IMBA's Guide to Building Sweet Singletrack,* 2004. International Mountain Bicycling Association.

The AASHTO Guide for the Development of Bicycle Facilities, 2012 edition (the Bike Guide) has an extensive section of design guidelines for Shared Use Paths, covering the following categories:

- Separation between Shared Use Paths and Roadways
- Width and Clearance
- Design Speed
- Horizontal Alignment
- Grade
- Sight Distance
- Path-Roadway Intersections
- Signing and Marking
- Other issues, such as Lighting; Restriction of Motor Vehicles; Railroad Crossings; etc.

Rather than duplicating the referenced design guidance here, this document will instead focus on issues and criteria specific to Albuquerque's multi-use trail system. The remainder of the material from the

AASHTO *Bike Guide* is incorporated herein by reference. In the event of a conflict with this or future versions of the referenced Guides, the more stringent criteria will apply.

The Federal Highway Administration's *Manual on Uniform Traffic Control Devices* (MUTCD), Part 9: Traffic Control for Bicycles, is the accepted reference for most matters relating to signage, signalization, and striping of bicycle trails. The MUTCD offers three levels of information: Standards, which must be followed; Guidance, which is recommended, but not required; and Options, which are permitted, and may or may not be followed, at the discretion of the local authority. The guidelines presented in the MUTCD should be followed in the design of Albuquerque's bikeways and trails.

## **B. Interagency Coordination Processes**

### **1. Shared Use of Irrigation Ditches (7.C.4.c)**

Any trail proposal for an MRGCD owned or managed facility has to be reviewed and approved by us for adequate right of way, current management and maintenance of that facility, landownership and ability for another local entity to manage and maintain the trail through a license agreement. The size of the facility and available right-of-way are strong determinants in the feasibility of a multi-use trail that can be separated from the MRGCD's required maintenance access. Other than at road crossings, rails and fences are generally not installed along ditch banks as they prevent or impede our access and maintenance.

Equestrians use unimproved maintenance roads and trails on our facilities and generally keep distance from bicycles and other fast moving users. Our ditches and drains are used by and very important to equestrians in the valley and we try to provide or maintain access wherever feasible/desirable.

Wherever possible, multi-use trails should meet ADA standards for design and access. It's helpful to make them higher in elevation than the maintenance road for drainage and so less material migrates onto the trail. The opinion about bollards is that they can cause some hazards on a trail but we are increasingly using them rather than the horse log step-overs to provide better access for those who have more mobility issues, bicycles, strollers, etc. while excluding vehicles and four and three wheelers (ATVs).

The trail corridors proposed for the Corrales Main Canal and Alameda Drain will need more study for feasibility. Some funding has been allocated for the Alameda Drain from Matthew Ave. north to Alameda Blvd. and reconnaissance and coordination efforts have commenced.

It would be good for the MRGCD, City and County to develop maintenance and management standards and signage/information more specific to trails on MRGCD facilities as the concerns, management, opportunities and purposes are unique.

## **2. Shared Use of Utility Corridors**

PNM transmission rights-of-way or easements are identified as the location for several proposed bike routes or trails. As the easement holder, PNM has the legal right to use and maintain the easement including ensuring vehicular access to the lines, maintaining adequate clearances, and other safety measures. If the bike lanes and/or trails become guest uses at these locations, an encroachment agreement will be necessary. The City also needs to directly contact the underlying property owner. In addition, it will be the City of Albuquerque's responsibility to ensure that PNM's uses of the easement are not affected or interfered with in any way by the inclusion of the bike lane or trail.

Four proposed bike lane and/or trail locations are identified within PNM's 115kV transmission rights-of-way and easements. The four locations are:

- Along the PNM CE 115kV transmission line from Irving Blvd. NW heading north toward McMahan Blvd. NW
- Along the PNM BW 115kV transmission line north of Interstate 40 east of Atrisco Vista Blvd NW
- Along the PNM SE 115kV transmission line/ID 46kV transmission line corridor in Tijeras Arroyo
- Along the PNM RE/ER 115kV transmission line corridor on San Antonio Drive NE just west of Tramway Blvd NE

Based on PNM's experience constructing and maintaining facilities at these locations, the terrain is difficult and is not conducive for bike trails. Coordination with PNM will be necessary as trails are developed at any of these four locations.

PNM does not support the development of trails within PNM existing 345kV transmission line rights-of-way or easements. The higher voltage lines can potentially result in electrical nuisance shocks. Nuisance shocks may occur when a person touches an ungrounded metal object, in this case, such as bicycle handlebars. A nuisance shock does not harm the recipient but can be startling. PNM will not grant an encroachment easement in 345kV transmission corridors.

## **3. New Mexico Department of Transportation (NMDOT)**

Any trail, lane, and route proposal for a NMDOT roadway facility will require review and approval by NMDOT for the following, but not limited to, adequate right-of-way, accessibility, connectivity, maintenance of the facility and need for license agreement.

As we had discussed, bringing some of the other agency coordination text referring to ADA compliance, design, feasibility, etc. to the introductory section would cover these items for all affected agencies.

## **C. On-Street Facilities**

### **1. Facility Selection**

There are a wide variety of techniques for selecting the type of facility for a given context. Roadway characteristics that are often used include:



- Motor vehicle speed and volume
- Demand for bikeway facilities
- Presence of heavy vehicles/trucks
- User preference
- Roadway width
- Land use/urban or rural context

There are no specific rules for determining the most appropriate type of facility for a particular location; engineering judgment and planning skills are critical elements of this decision.

A 2002 study combined bikeway dimension standards for ten different communities in North America. The goal of the study was to survey the varying requirements available and provide a best practices approach for providing bikeway facilities. The study included a comparison with European standards and found that: “North Americans rely much more on wide lanes for bicycle accommodation than their counterparts overseas.” The table below shows the results of this analysis, which recommends use of bike lanes or shoulders, wide lanes, or normal lanes.

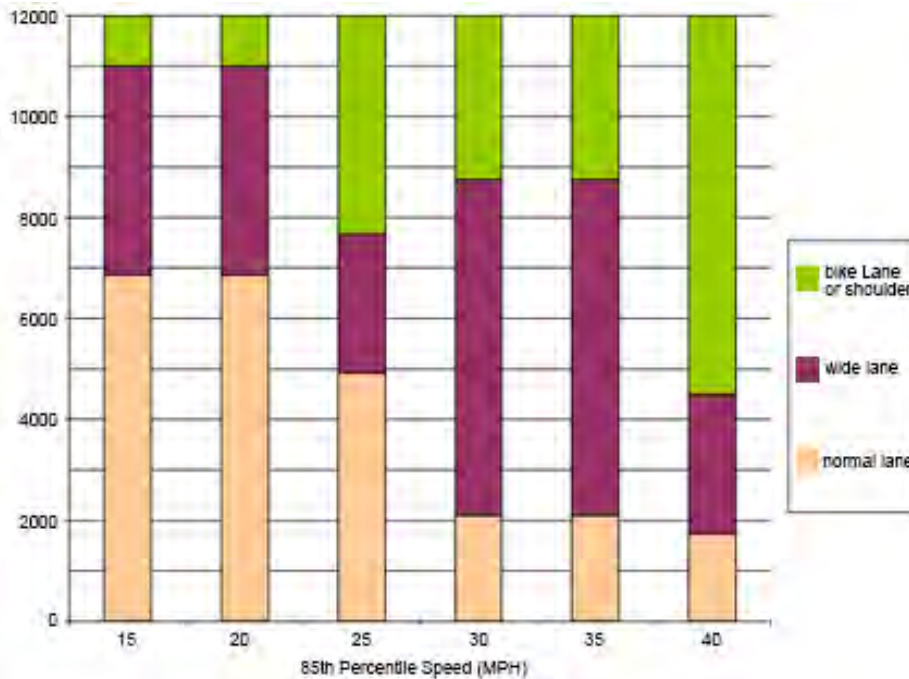


Table 1: North American Bicycle Facility Selection Chart (King, Michael. (2002). Bicycle Facility Selection: A Comparison of Approaches. Pedestrian and Bicycle Information Center and Highway Safety Research Center, University of North Carolina – Chapel Hill.)

The City adopts this table as its guidance for determining the appropriate facility type. In the future, traffic volume and road speeds may be different from the conditions when this plan was adopted. When new bikeways and trails facilities are being planned, designers should consult this table to ensure that the proposed facility type is appropriate.

## 2. Shared Roadways

### Design Summary

- Any street without specific bikeway facilities where bicycling is permitted.
- Can be signed connections, often to trails or other major destinations.
- Sign R4-11 BICYCLES MAY USE FULL LANE may be used on roadways where no bicycle lanes or adjacent shoulders usable by bicyclists are present and where travel lanes are too narrow for bicyclists and motor vehicles to operate side by side (MUTCD Section 9B.06).

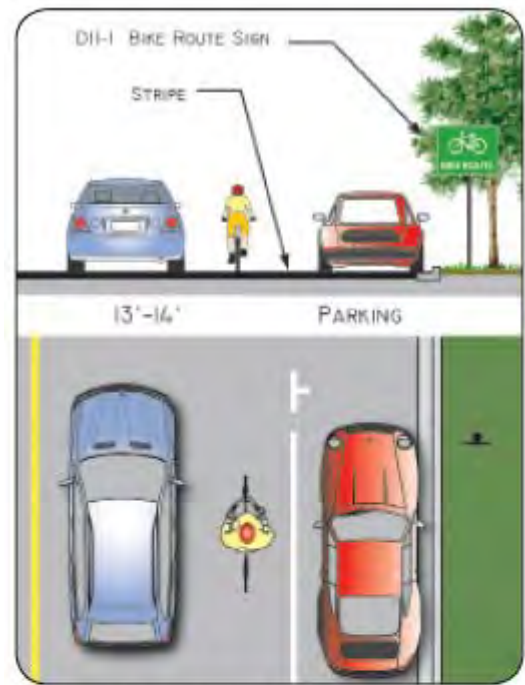
### Discussion

A treatment appropriate for commuter riders and those accessing a trail, shared roadways can provide a key connection. Shared roadways are indicated exclusively by signage, which provide key connections to destinations and trails where providing additional separation is not possible.

Roadways appropriate for shared roadways often have a centerline stripe only and no designated shoulders. Bicyclists are forced to share a travel lane with automobiles. This type of facility can be developed on a rural roadway without curbs and gutters. It can also be used on an urban road where traffic speeds and volumes are low, although shared lane markings in addition to signage may be more appropriate in these locations.

### Guidance

- The City of Albuquerque Development Process Manual (DPM) defines shared roadways as, “any roadway that may be legally used by both motor vehicles and bicycles and is not specifically designated as a bikeway.”
- The DPM states that, “where trails intersect with the street network, safe connections to the on-street bikeway system should be designed.” Shared routes may be an appropriate treatment for such connections.
- See also: MUTCD Section 9B. 20 Bicycle Guide Signs.



Shared roadway recommended configuration.



This bike route in Los Angeles provides a wide outside lane adjacent to on-street parking.

### 3. Shoulder Bikeways

#### Design Summary

DPM recommended widths (measured from painted edge-line to edge of pavement):

- 6 feet on roadways with posted speed limits of 40 mph or greater.
- 5 feet on roadways with posted speed limits of 35 mph or below.
- 4 feet may be considered on low-speed, low-volume streets where right-of-way constraints exist.
- Can include pavement markings and Share the Road signage.
- See bike lane section (Page 12) for additional guidance for determining if bike lanes are required.

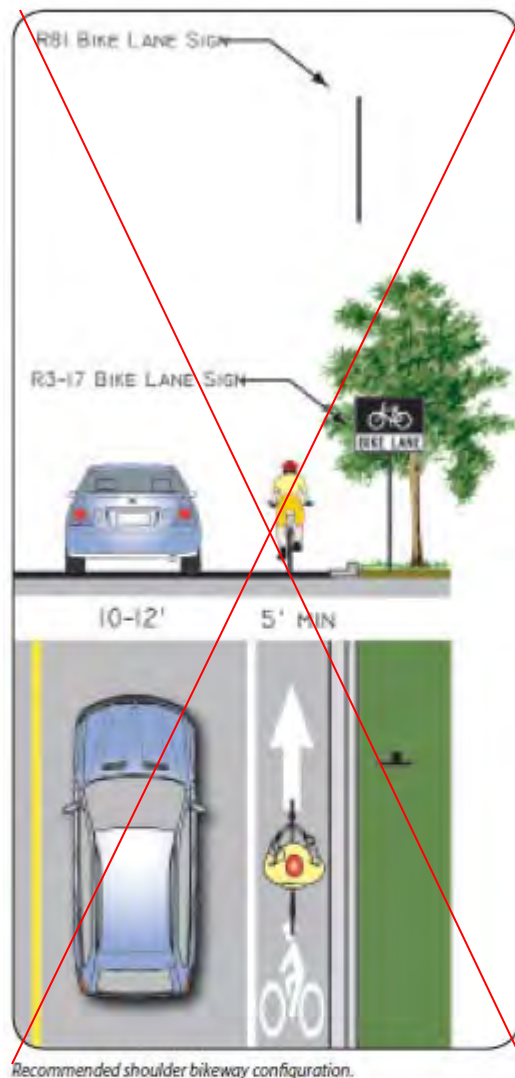
#### Discussion

On streets without adequate space for bike lanes or on rural roads with a large shoulder, shoulder bikeways can accommodate bicycle travel. Shoulder bikeways are generally used by commuter and long-distance recreational riders, rather than families with children or more inexperienced riders.

In many cases, the opportunity to develop a full standard bike lane on a street where it is desirable may be many years. It is possible to stripe the shoulder in lieu of bike lanes if the area is 50 percent of the desirable bike lane width and the outside lane width can be reduced to the American Association of State Highway and Transportation Officials (AASHTO) minimum. If the available bike lane width is two-thirds of the desirable bike lane width, the full bike lane treatment of signs, legends and an 8-foot bike lane line would be provided. Where feasible, extra width should be provided with pavement resurfacing jobs, but not exceeding desirable bike lane widths.

#### Guidance

The DPM states that, “paved shoulder bikeways are located on uncurbed arterials and collectors and consist of a smooth paved surface that covers all or part of the roadway shoulder.” The DPM also



Shoulder bikeways are appropriate along wide rural roads where vehicles can avoid passing close to bicyclists.



specifies that bike lanes and paved shoulders are the standard treatments for use on arterial or collector streets.

The New Mexico Bicycle-Pedestrian-Equestrian Advisory Plan provides guidance on the use of rumble strips to provide a buffer on roadway shoulders. It also has information about guard rails, pavement edges and shoulder continuity.

See also: MUTCD Section 9B. 20 Bicycle Guide Signs.

#### 4. Wide Curb Lane

##### *Design Summary*

Outside lane widths of 14-16 feet (DPM) or 14-15 feet (NM BPE Plan).

- The width of the door zone is generally assumed to be 2.5 feet from the edge of the parking lane.
- Place in a linear pattern along a corridor (typically every 100-200 feet).

Recommended Placement:

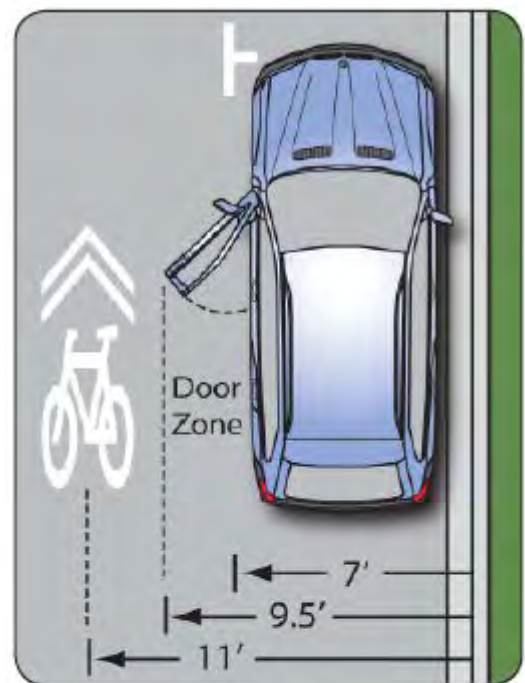
- At least 11 feet from face of curb (or shoulder edge) on streets with on-street parking.
- At least 4 feet from face of curb (or shoulder edge) on streets without on-street parking.

##### *Discussion*

On wide curb lane bikeways, high-visibility pavement markings, called shared lane markings (also known as sharrows), are used to position bicyclists within the travel lane. These markings are often used on streets where dedicated bike lanes are desirable but are not possible due to physical or other constraints. Shared lane markings are placed strategically in the travel lane to alert motorists of bicycle traffic, while also encouraging cyclists to ride at an appropriate distance from the “door zone” of adjacent parked cars. Shared lane markings also encourage cyclists to ride in a straight line so their movements are predictable to motorists. Shared lane markings made of thermoplastic tend to last longer than painted ones.

##### *Guidance*

The 2009 MUTCD notes that shared lane markings should not



Shared lane marking placement guidance for streets with on-street parking.



Shared lane markings are currently used in Albuquerque.

be placed on roadways with a speed limit over 35 mph, and that when used the marking should be placed immediately after an intersection and spaced at intervals no greater than 250 feet thereafter. Placing shared lane markings between vehicle tire tracks (if possible) will increase the life of the markings. (See MUTCD Section 9C.07).

## 5. Bike Lanes

### *Design Summary*

Designated exclusively for bicycle travel, bike lanes are separated from vehicle travel lanes with striping and also include pavement stencils. Bike lanes are most appropriate on arterial and collector streets where higher traffic volumes and speeds warrant greater separation.

The DPM recommends minimum bike lane widths of:

- 5 feet, measured from painted edgeline to edge of gutter, on roadways with posted speed limits of 40 mph or greater.
- 4 feet, measured from painted edgeline to edge of gutter, on roadways with posted speed limits of 35 mph or less.

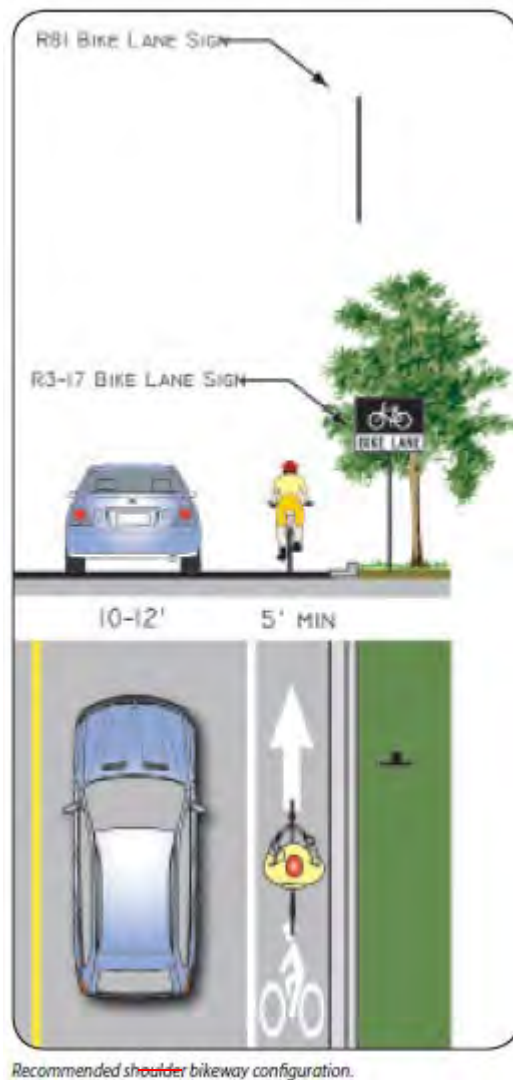
However, AASHTO and other guidance authorities recommends a 5-foot minimum for bike lanes, with 4 feet only in restricted corridors. This text should be considered for revision to specify that a 5-foot bike lane is recommended on streets with posted speed limits of 35 mph or less. In addition, the DPM should specify that bike lanes are measured to the inside edge of the gutter pan, ensuring smooth pavement rather than a gutter edge in the bike lane.

### *Discussion*

Many bicyclists, particularly less experienced riders, are more comfortable riding on a busy street if it has a striped and signed bike lane than if they are expected to share a wide lane. Providing marked facilities such as bike lanes is one way of helping to persuade more tentative riders to try bicycling.

Bike lanes can increase safety-the feeling of security and promote proper riding by:

- Defining road space for bicyclists and motorists, reducing the possibility that motorists will stray into the cyclists' path
- Discouraging bicyclists from riding on the sidewalk
- Reminding motorists that cyclists have a right to the





road.

In an urban setting, it is crucial to ensure that bike lanes and adjacent parking lanes have sufficient width, so that cyclists have enough room to avoid opened vehicle doors.

### *Additional Guidance*

The DPM defines a bike lane as, “a lane on the roadway that has been designated by striping, signing and pavement markings for preferential or exclusive use by bicyclists.” The DPM recommends the provision of bike lanes on all new or reconstructed arterial and collector roadways.

The DPM also specifies that high-speed traffic (posted speed of 40 mph or greater) and the presence of large vehicles (truck, bus or recreational vehicle) are significant factors affecting the acceptability of potential bikeway locations. In locations where these conditions exist, bike lane widths of 5-foot or greater are recommended.

The AASHTO Guide for the Development of Bicycle Facilities guideline states that, “If used, the bicycle lane symbol marking shall be placed immediately after an intersection and other locations as needed... If the word or symbol pavement markings are used, Bicycle Lane signs shall also be used, but the signs need not be adjacent to every symbol to avoid overuse of the signs.”

The New Mexico Bicycle and Pedestrian Plan specifies that, “A vertical edge of pavement should not be left in the useable shoulder area or bicycle lane after construction or maintenance,” stating that 4 feet (minimum) of clear space should be provided and noting that partial overlays create undue hazards for cyclists.

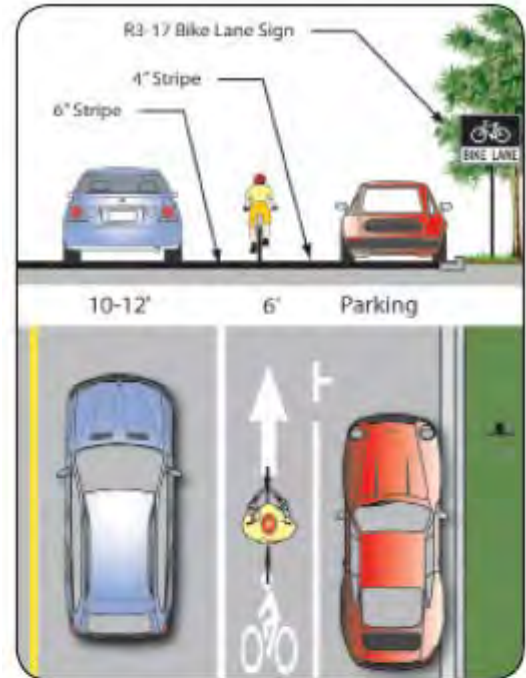
See also MUTCD Section 9C.04 Markings for Bicycle Lanes.

### ***Bike Lane Adjacent to On-Street Parallel Parking*** ***(7.B.5.a)***

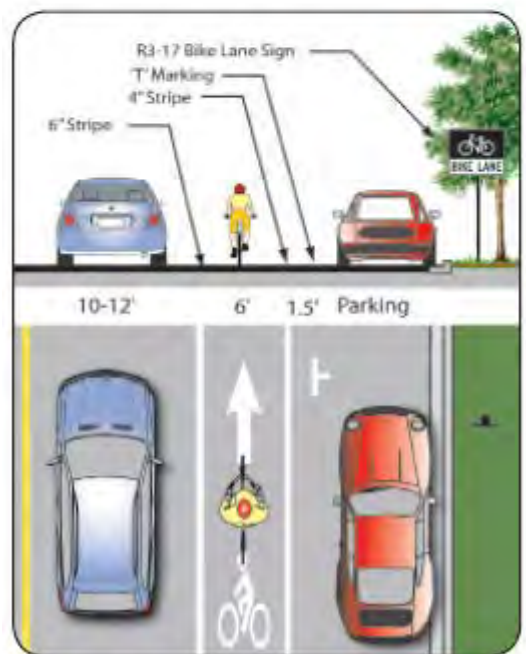
#### *Design Summary*

#### **Bike Lane Width**

- 6 feet recommended when parking stalls are marked.



*Parking 'T' bike lane design.*



*Parking buffer bike lane design.*

- 4 feet minimum in constrained locations.
- 5 feet acceptable if parking not marked (drivers tend to park closer to the curb where parking is unmarked).
- 7 feet maximum (greater widths may encourage vehicle loading in bike lane).

### **Travel Lane Width**

- 12 feet for a shared lane adjacent to a curb face.
- 11 feet minimum for a shared bike/parking lane where parking is permitted but not marked on streets without curbs.

### *Discussion*

Bike lanes adjacent to on-street parallel parking are common in the U.S. and can be dangerous for bicyclists if not designed properly. Crashes caused by a suddenly opened vehicle door are a common hazard for bicyclists using this type of facility. On the other hand, wide bike lanes may encourage the cyclist to ride farther to the right (door zone) to maximize distance from passing traffic. Wide bike lanes may also cause confusion with unloading vehicles in busy areas where parking is typically full.

Some treatments to encourage bicyclists to ride away from the door zone include:

- Installing parking “T’s” and smaller bike lane stencils placed to the left (see graphic at top).
- Provide a buffer zone (preferred design; shown bottom). Bicyclists traveling in the center of the bike lane will be less likely to encounter open car doors. Motorists have space to stand outside the bike lane when loading and unloading.

### *Guidance*

From AASHTO Guide for the Development of Bicycle Facilities:

“If parking is permitted, the bike lane should be placed between the parking area and the travel lane and have a minimum width of 5 feet. Where parking is permitted but a parking stripe or stalls are not utilized, the shared area should be a minimum of 11 feet without a curb face and adjacent to a curb face. If the parking volume is substantial or turnover is high, an additional 1-2 feet of width is desirable.”

## ***Bike Lane Adjacent to On-Street Diagonal Parking*** ***(7.B.5.b)***

### *Design Summary*

#### **Bike Lane Width**

- 5 feet minimum.
- White 4 inch stripe separates bike lane from parking bays.
- White 6 inch stripes separate bike lane from motor vehicle travel lanes.
- Parking bays are sufficiently long to accommodate most vehicles (vehicles do not block bike lane).

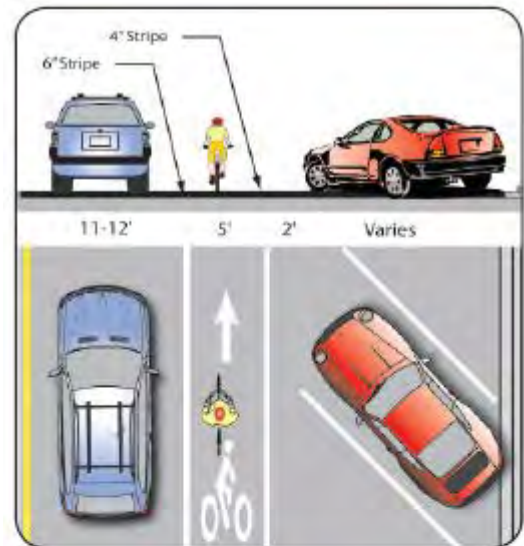
### *Discussion*

In areas with high parking demand such as urban commercial areas, diagonal parking can be used to increase parking supply. Conventional “head-in” diagonal parking is not recommended in conjunction with high levels of bicycle traffic or with the provision of bike lanes as drivers backing out of conventional diagonal parking spaces have poor visibility of approaching bicyclists.

The use of back-in diagonal parking or reverse angled parking is recommended over head-in diagonal parking. This design addresses issues with diagonal parking and bicycle travel by improving sight distance between drivers and bicyclists and has other benefits to vehicles including: loading and unloading of the trunk occurs at the curb rather than in the street, passengers (including children) are directed by open doors towards the curb and no door conflict with bicyclists. While there may be a learning curve for some drivers, using back-in diagonal parking is typically an easier maneuver than conventional parallel parking.

### *Guidance*

This treatment is currently slated for inclusion in ~~the upcoming update of~~ the 2012 AASHTO Guide for the Development of Bicycle Facilities.



*'Back-in' diagonal parking is safer for cyclists than 'head-in' diagonal parking due to drivers' visibility as they exit the parking spot.*



**Bike Lane Without On-Street Parking (7.B.5.c)**

*Design Summary*

**Bike Lane Width**

- 4 feet minimum when no curb & gutter is present.
- 5 feet minimum when adjacent to curb and gutter.

**Recommended Width**

- 6 feet where right-of-way allows.

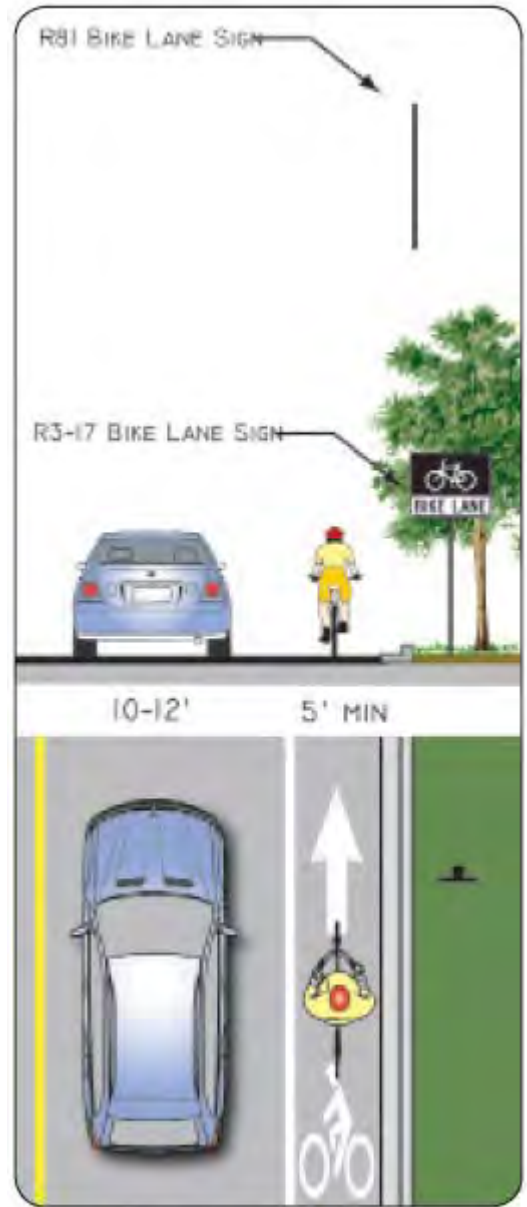
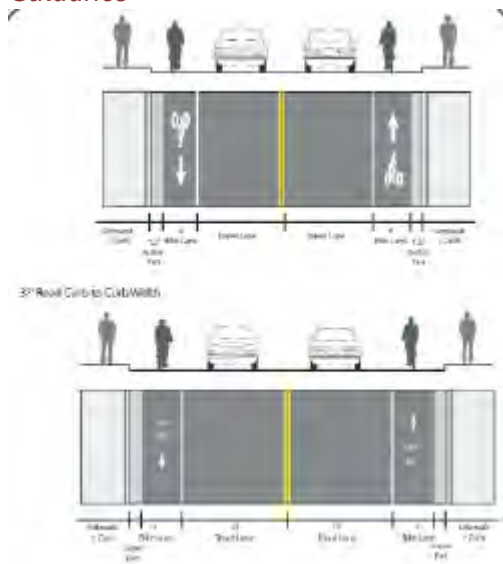
**Maximum Width**

- 8 feet adjacent to arterials with high travel speeds (45 mph or more).

*Discussion*

Wider bike lanes are desirable in certain circumstances such as on higher speed arterials (45 mph or more) where a wider bike lane can increase separation between passing vehicles and cyclists. Wide bike lanes are also appropriate in areas with high bicycle use. A bike lane width of 6-8 feet makes it possible for bicyclists to ride side-by-side or pass each other without leaving the bike lane, increasing the capacity of the lane. Appropriate signing and stenciling is important with wide bike lanes to ensure motorists do not mistake the lane for a vehicle lane or parking lane.

*Guidance*



Recommend bike lane without on-street parking design.

Two Lane Cross-Section with No Parking\*. \*Bike lanes may be 4' in width under constrained circumstances.

## ***Bike Lane Striping at Intersections (7.B.5.d)***

### ***Design Summary***

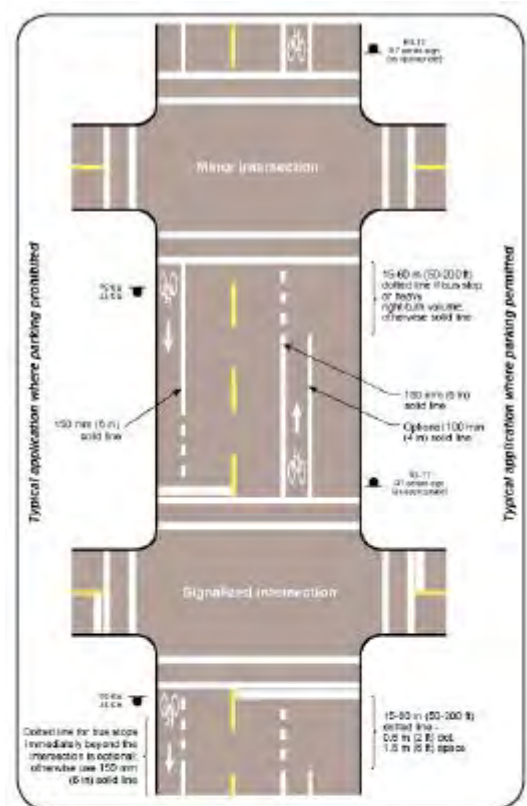
- Stop striping bike lanes at painted crosswalks or the near side cross street property line
- At complex intersections, bike lanes may be dotted.
- At signalized or stop-controlled intersections with right-turning motor vehicles or at bus stops on the near side of the intersection, replace the solid striping to the approach should be with a broken line with 2-foot dots and 6-foot spaces for 50 to 200 feet.
- If a bus stop is located on a far side of the intersection, replace the solid white line with a broken line for at least 80 feet from the crosswalk on the far side of the intersection.
- At T-intersections with no painted crosswalks, continue the bike lane striping on the side across from the T-intersection through the intersection area with no break.

### ***Discussion***

Bike lane striping should be brought to the crosswalk or property line on the near side of an intersection. Bike lane striping is not continued through intersections, except where high volumes of motor vehicles are turning right, a bus stop is located in advance of or on the far side of the intersection or at a complex intersection. In the example photo from Portland, Ore., bicyclists are directed on the right hand side of a light rail stop, while the road continues to the left. This diversion sets cyclists up to cross the light rail tracks at a 90 degree angle.

Some jurisdictions are experimenting with using shared lane markings or other high-visibility pavement markings through intersections. At high-speed intersections, such as where a highway on- or off-ramp crosses a bike lane, colored pavement can be used to highlight the conflict area (see innovative design guidelines).

Consistency of intersection design and visibility of cyclists travelling in a bike lane should be a priority to accommodate bicyclists through intersections.



Typical pavement markings for bike lane on two-way street (AASHTO)



Bike lane dashed through complex intersection.

### Guidance

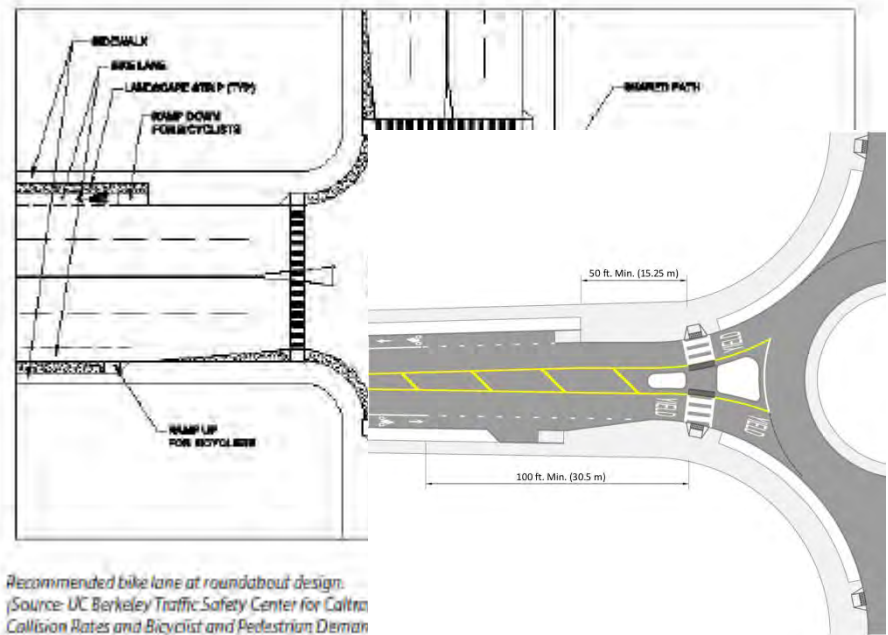
AASHTO Guide for the Development of Bicycle Facilities (1999).

### Bike Lanes at Roundabouts

#### (7.B.5.e)

#### Design Summary

- Reduce the speed differential between circulating motorists and bicyclists (25 mph maximum circulating design speed).
- Design approaches/exits to the lowest speeds possible to reduce the severity of potential collisions with pedestrians.
- Encourage bicyclists navigating the roundabout like motor vehicles to “take the lane”
- Maximize yielding rate of motorists to pedestrians and bicyclists
- Provide separated facilities for bicyclists who prefer not to navigate the roundabout on the roadway.
- Indicate to drivers and bicyclists the correct way for them to circulate through the roundabout through appropriately designed signage, pavement markings and geometric design elements.
- Indicate to drivers, bicyclists and pedestrians the right-of-way rules through appropriately designed signage, pavement markings and geometric design elements.



### Discussion

Research indicates that while single-lane roundabouts may benefit bicyclists and pedestrians by slowing traffic, multi-lane roundabouts may significantly increase safety-potential problems for these users.

Multi-lane roundabouts pose the following challenges to bicyclists riding in a bike lane:

- Bicyclists must take the lane before they enter the roundabout to avoid becoming caught in a “right hook,” a situation in which a motorist turns right, across the path of a bicyclist traveling straight. Entry leg speeds must be slow enough for bicyclists to be able to take the lane safely, securely merge with traffic.
- Theoretically, once motor vehicle volumes reach a certain magnitude, there are no gaps in traffic large enough to accommodate a bicyclist.
- Bicyclists must be able to correctly judge the speed of circulating motorists to find a gap that is large enough for them to safely enter, effectively merge in the roundabout. This task is particularly difficult if the circulating motorists are traveling at a much higher speed than the bicyclists. In



addition, if circulating speeds in a roundabout are much higher than 20 mph, drivers behind a bicyclist may become impatient and may pass the bicyclist and turn in front of him, creating more risks for the bicyclist.

- As a circulating bicyclist approaches an entry lane, a driver waiting to enter must notice the bicyclist, properly judge the bicyclist's speed and yield to him/her if necessary. In a location where there are few bicyclists, motorists may not even register that there is a bicyclist approaching. If a bicyclist is hugging the curb, s/he may be outside the motorist's cone of vision.

### Guidance

The New Mexico Bicycle-Pedestrian-Equestrian Advisory Plan state provides additional guidance for providing bicycle travel around roundabouts.

### Retrofitting Existing Streets with Bike Lanes - Roadway Widening (7.B.5.f)

Most major streets in Albuquerque are characterized by conditions (e.g., high vehicle speeds and/or volumes) for which dedicated bike lanes are appropriate to easily accommodate ~~safe and~~ comfortable riding. Although opportunities to add bike lanes through roadway widening may exist in some locations, most major streets in Albuquerque pose physical and other constraints requiring street retrofit measures within existing curb-to-curb widths. As a result, many of the recommended measures effectively reallocate existing street width through striping modifications to accommodate dedicated bike lanes.

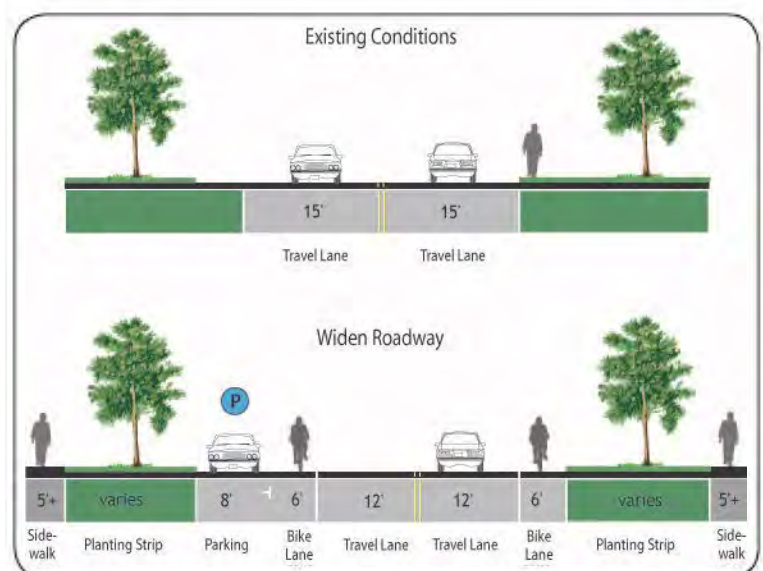
The DPM notes that, "the addition of bike lanes as part of arterial and collector rehabilitation is recommended where feasible." While largely intended for major streets, these measures may be appropriate on some lower-order streets where bike lanes would best accommodate cyclists.

### Design Summary

- 6 feet preferred.
- 4 feet minimum (see bike lane guidance).

### Discussion

Bike lanes could be accommodated on several streets with excess right-of-way through shoulder widening. Although street widening incurs higher expenses compared with re-striping projects, bike lanes could be added to streets currently lacking curbs, gutters and sidewalks without the high costs of major infrastructure reconstruction.



Example of roadway widening to accommodate bike lanes and sidewalks.

As a long-term measure, the City should find opportunities to add bike lanes to other major streets where they are needed. Opportunities include adding bike lanes as streets and bridges are widened for additional auto capacity or as property development necessitates street reconstruction.

**Retrofitting Existing Streets with Bike Lanes - Lane Narrowing (Road Diet 1) (7.B.5.g)**

*Design Summary*

**Vehicle Lane Widths**

- Before: 12-15 feet; after: 10-11 feet.

**Bike Lane Width**

- See bike lane design guidance.

*Discussion*

Also called a ‘Road Diet,’ lane narrowing utilizes roadway space that exceeds minimum standards to create the needed space to provide bike lanes. Many roadways in Albuquerque have existing lanes that are wider than those prescribed in local and national roadway design standards, or which are not marked. Most standards allow for the use of 11-foot wide and sometimes 10-foot wide travel lanes to create space for bike lanes.

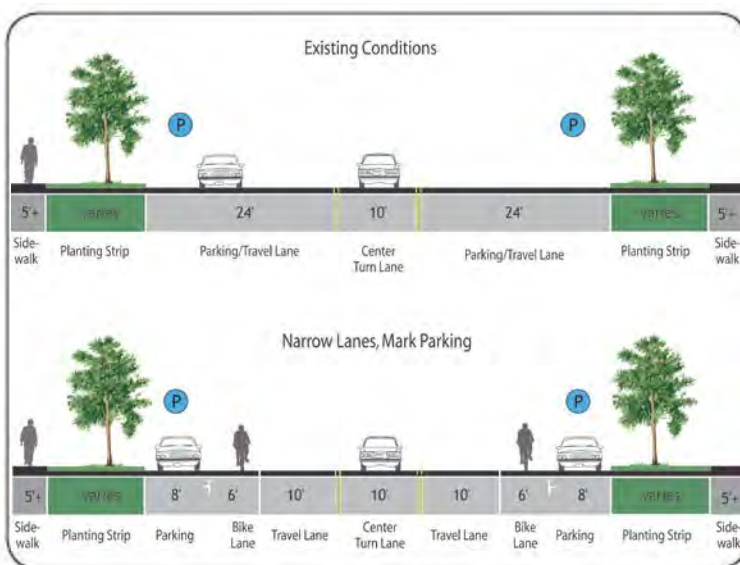
Special consideration should be given to the amount of heavy vehicle traffic and horizontal curvature before the decision is made to narrow travel lanes. Center turn lanes can also be narrowed in some situations to free up pavement space for bike lanes.

*Guidance*

Example of vehicle travel lane narrowing to accommodate bike lanes.



This street in Portland, Oregon previously had 13' lanes, which were narrowed to accommodate bike lanes without removing a lane.



Example of vehicle travel lane narrowing to accommodate bike lanes.

## Retrofitting Existing Streets with Bike Lanes - Lane Reconfiguration (Road Diet 2) (7.B.5.h)

### Design Summary

#### Vehicle Lane Widths

- Width depends on project. No narrowing may be needed if a lane is removed.

#### Bike Lane Width

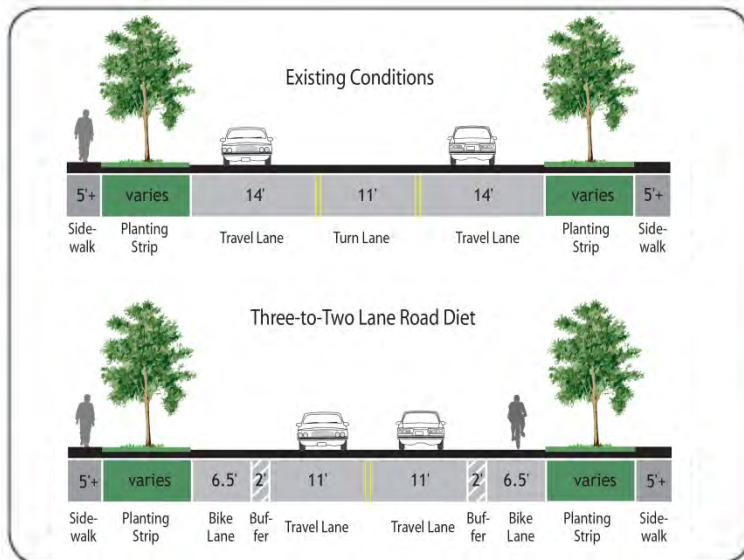
- See bike lane design guidance.

### Discussion

The removal of a single travel lane will generally provide sufficient space for bike lanes on both sides of a street. Streets with excess vehicle capacity provide opportunities for bike lane retrofit projects. Depending on a street's existing configuration, traffic operations, user needs and ~~safety concerns~~ access demands, various lane reduction configurations exist. For instance, a four-lane street (with two travel lanes in each direction) could be modified to include one travel lane in each direction, a center turn lane and bike lanes. Prior to implementing this measure, a traffic analysis should identify impacts.

This treatment is slated for inclusion in ~~the update to the~~ 2012 AASHTO Guide for the Development of Bicycle Facilities.

### Guidance



Example of vehicle travel lane reconfiguration to accommodate bike lanes.



This road was re-stripped to convert four vehicle travel lanes into three travel lanes with bike lanes.



**Retrofitting Existing Streets with Bike Lanes - Parking Reduction (Road Diet 3) (7.B.5.i)**

*Design Summary*

**Vehicle Lane Widths**

- Width depends on project. No narrowing may be needed depending on the width of the parking lane to be removed.

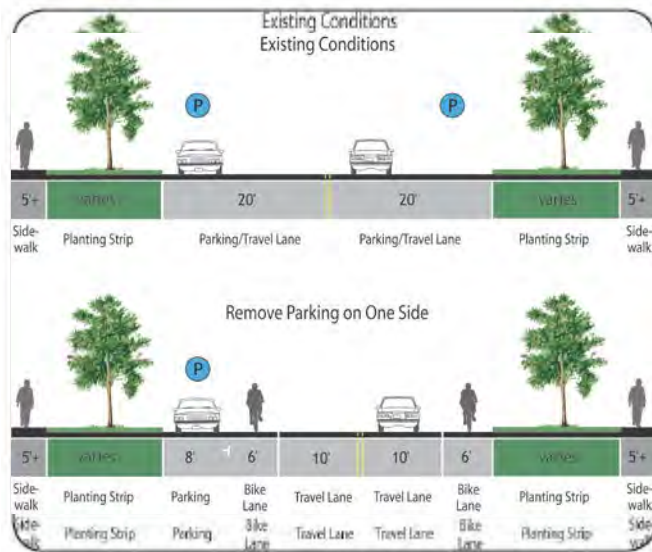
**Bike Lane Width**

- See bike lane design guidance.

*Discussion*

Bike lanes could replace one or more on-street parking lanes on streets where excess parking exists and/or the importance of bike lanes outweighs parking needs. For instance, parking may be needed on only one side of a street (as shown below and at right). Eliminating or reducing on-street parking also improves sight distance for cyclists in bike lanes and for motorists on approaching side streets and driveways. Prior to reallocating on-street parking for other uses, a parking study should be performed to gauge demand and to evaluate impacts to people with disabilities.

*Guidance*



*Recommended design for bike routes/ bicycle boulevards.*



*Some streets may not require parking on both sides.*

## 6. Bicycle Boulevards

### *Design Summary*

- Roadway width varies depending on roadway configuration.
- Use D11-1 “Bike Route” sign as specified for shared roadways.
- Shared lane markings may be applied.
- Intersection treatments, traffic calming and traffic diversions can be utilized to improve the cycling environment, as recommended in the following pages.



*Bicycle boulevards are low-speed streets that provide a comfortable and pleasant experience for cyclists.*

### *Discussion*

Treatments for bicycle boulevards include five application levels, which are rated based on their level of physical intensity. This helps identify the appropriate application level for individual bicyclists. Level one represents the least physically intensive treatments that could be implemented at a relatively low cost.

Traffic calming and other treatments along the corridor reduce vehicle speeds so that motorists and bicyclists generally travel at the same speed, creating a more-comfortable environment for all users. Bicycle boulevards incorporate treatments to facilitate convenient crossings where the route crosses a major street. They work best in well-connected street grids where riders can follow reasonably direct and logical routes and when higher-order parallel streets exist to serve through vehicle traffic.

Bicycle boulevards/bike routes can be treated with shared lane markings, directional signage, traffic diverters, chicanes, chokers and /or other traffic calming devices to reduce vehicle speeds or volumes.

Bicycle boulevards can employ a variety of treatments from signage to traffic calming and pavement stencils. The level of treatment provided at a specific location depends on several factors, discussed below.

### *Guidance*

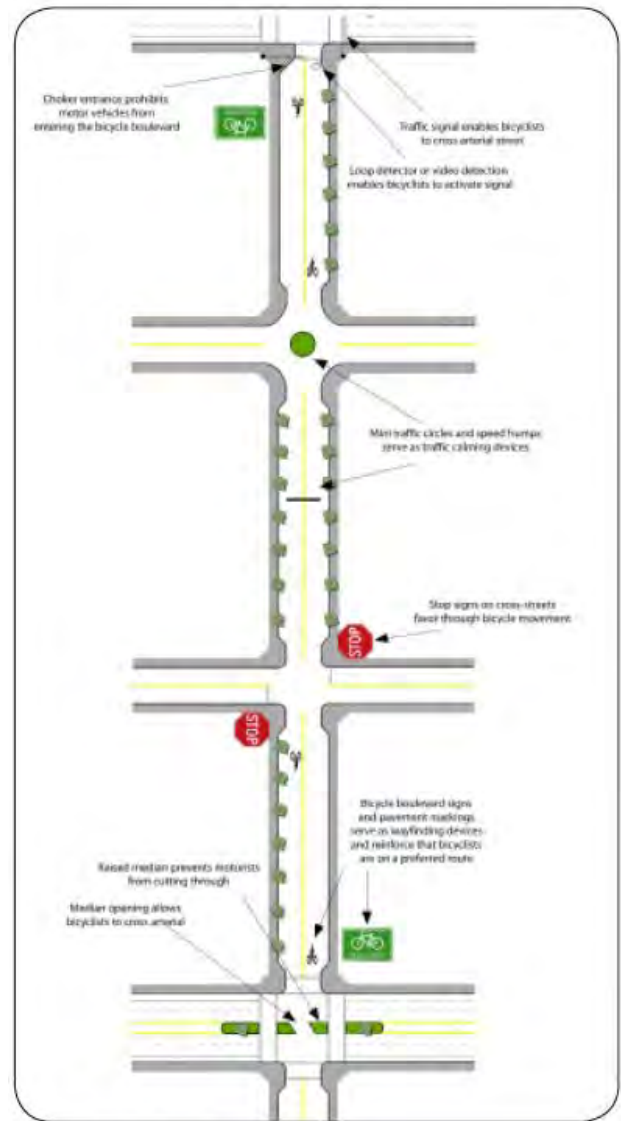
- The DPM defines a bicycle boulevard as, “a bike route designed to encourage the through movement of bicycles while maintaining local access for motor vehicle travel.”
- Bicycle boulevards have been implemented in California in Berkeley, Emeryville, Palo Alto, San Luis Obispo and Pasadena; in Oregon in Portland and Eugene; in Madison, Wis.; in Vancouver, B.C.; in Tucson, Ariz.; in Minneapolis, Minn.; in Ocean City, Md.; and in Syracuse, N.Y.
- Alta Planning + Design and IBPI. Bicycle Boulevard Planning and Design Handbook. [www.ibpi.usp.pdx.edu/guidebook.php](http://www.ibpi.usp.pdx.edu/guidebook.php)
- City of Berkeley. (2000). Bicycle Boulevard Design Tools and Guidelines. <http://www.ci.berkeley.ca.us/contentdisplay.aspx?id=6652>

- AASHTO Guide for the Development of Bicycle Facilities.

*Discussion (continued)*

Bicycle boulevards serve a variety of purposes:

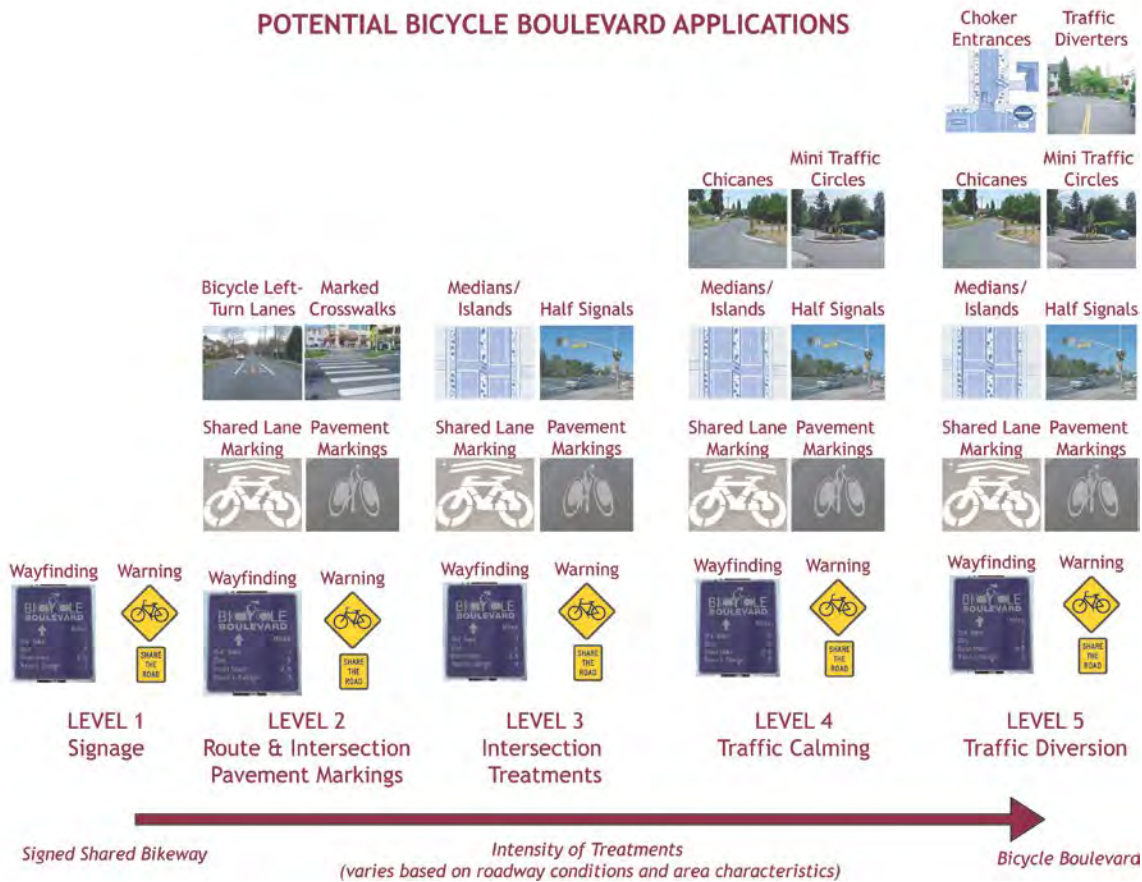
- **Parallel major streets lacking dedicated bicycle facilities:** Higher-order streets typically include major bicyclist destinations (e.g., commercial and employment areas). However, these corridors often lack bike lanes or other dedicated facilities creating an uncomfortable, unattractive and potentially **unsafe-undesirable** riding environment. Bicycle boulevards serve as alternate parallel facilities that allow cyclists to avoid major streets for longer trips.
- **Parallel major streets with bicycle facilities that are uncomfortable for some users:** Some users may not feel comfortable using bike lanes on major streets due to high traffic volumes and vehicle speeds, conflicts with motorists entering and leaving driveways and/or conflicts with buses loading and unloading passengers. Children and less-experienced riders might find these environments especially challenging. Utilizing lower-order streets, bicycle boulevards provide alternate route choices for these bicyclists. It should be noted that bike lanes on major streets provide important access to key land uses, and the major street network often provides the most direct routes between major destinations. For these reasons, bicycle boulevards should complement a bike lane network and not serve as a substitute.
- **Ease of implementation on most local streets:** bicycle boulevards incorporate cost-effective and less physically-intrusive treatments than bike lanes and cycle tracks. Most streets could be provided relatively inexpensive treatments like new signage, pavement markings, striping and signal improvements to facilitate bicyclists' mobility and **safety protection**. Other potential treatments include curb extensions, medians and other features that can be implemented at reasonable cost and are compatible with emergency vehicle accessibility.



Sample bicycle boulevard treatments.



- Benefits beyond an improved bicycling environment:** Residents living on bicycle boulevards benefit from reduced vehicle speeds and through traffic, creating a **safer and more-attractive, vehicle-restricted** environment. Pedestrians and other users can also benefit from boulevard treatments (e.g., by improving the crossing environment where boulevards meet major streets).



It should be noted that corridors targeted for higher-level applications would also receive relevant lower-level treatments. For instance, a street targeted for Level 3 applications should also include Level 1 and 2 applications as necessary. It should also be noted that some applications may be appropriate on some streets while inappropriate on others. In other words, it may not be appropriate or necessary to implement all Level 2 applications on a Level 2 street. Furthermore, several treatments could fall within multiple categories as they achieve multiple goals. To identify and develop specific treatments for each bicycle boulevard, the City should involve the bicycling community and neighborhood groups. Further analysis and engineering work may also be necessary to determine the feasibility of some applications.

The City should strive to implement bicycle boulevards of Level 3 or higher, with additional traffic calming or diversion as needed.

## Bicycle Boulevard Signing (7.B.6.a)

### Design Summary

- Signing is a cost-effective and highly visible treatment that can improve the riding environment on a bicycle boulevard.
- The City should adopt consistent signage and paint markings throughout the region.

### Discussion

Wayfinding signs are typically placed at key locations leading to and along bicycle boulevards, including where multiple routes intersect and at key bicyclist “decision points.”

Wayfinding signs displaying destinations, distances and “riding time” can dispel common misperceptions about time and distance while increasing users’ comfort and accessibility to the boulevard network.

Wayfinding signs also visually cue motorists that they are driving along a bike route and should correspondingly use caution. Note that too many signs tend to clutter the right-of-way, and it is recommended that these signs be posted at a level most visible to bicyclists and pedestrians, rather than per vehicle signage standards.

Warning signs advising motorists to “share the road” and “watch for bicyclists” may also improve bicycling conditions on shared streets. These signs are especially useful near major bicycle trip generators such as schools, parks and other activity centers. Warning signs should also be placed on major streets approaching bicycle boulevards to alert motorists of bicyclist crossings.

### Guidance

- Alta Planning + Design and IBPI. Bicycle Boulevard Planning and Design Handbook. [www.ibpi.usp.pdx.edu/guidebook.php](http://www.ibpi.usp.pdx.edu/guidebook.php)
- City of Berkeley. (2000). Bicycle Boulevard Design Tools and Guidelines.
- AASHTO Guide for the Development of Bicycle Facilities.
- MUTCD.



Sample bicycle boulevard signage.



Wayfinding signs help bicyclists stay on designated bike routes.

## Level 2: Bicycle Boulevard Pavement Markings (7.B.6.b)

### Design Summary

Use pavement markings to designate bicycle boulevards and provide directional/wayfinding information.

### Discussion

#### On-Street Parking Delineation

Delineating on-street parking spaces with paint or other materials clearly indicates where a vehicle should be parked and can discourage motorists from parking their vehicles too far into the adjacent travel lane. This helps cyclists by maintaining a wide enough space to **safely-comfortably** share a travel lane with moving vehicles while minimizing the need to swerve farther into the travel lane to maneuver around parked cars.

In addition to benefiting cyclists, delineated parking spaces also promote the efficient use of on-street parking by maximizing the number of spaces in high-demand areas.

#### Centerline Striping Removal

Automobiles have an easier time passing cyclists on roads without centerline stripes for the majority of the block length. If vehicles cannot easily pass each other using the full width of the street, it is likely that there is too much traffic for the subject street to be a successful bicycle boulevard. In addition, not striping the centerline reduces maintenance costs. Berkeley paints a double yellow centerline from 40-50 feet at uncontrolled or stop-controlled intersections, as well as pavement reflectors to identify the center of the street.

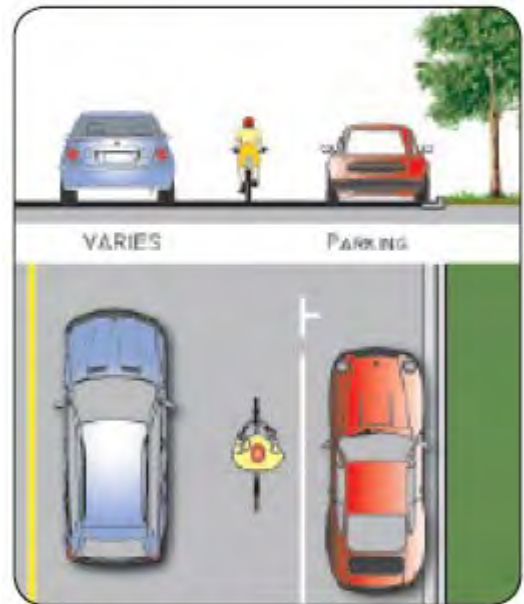
#### Directional Pavement Markings (Non-standard treatment)

Directional pavement markings (also known as bicycle boulevard markings) lead cyclists along a boulevard and reinforce that they are on a designated route. Markings can take a variety of forms, such as small bicycle symbols placed every 600-800 feet along a linear corridor, as previously used on Portland, Oregon's boulevard network.

Recently, jurisdictions have been using larger, more visible



Shared lane markings also provide directional support for bicyclists.



Example of on-street parking delineation.



Bicycle boulevard directional marker.



pavement markings. Shared lane markings could be used as bicycle boulevard markings, as Portland, Ore., has moved towards using. See shared lane marking guidelines for additional information on this treatment.

In Berkeley, Calif., non-standard pavement markings include larger-scale lettering and stencils to clearly inform motorists and bicyclists of a street’s function as a bicycle boulevard.

### Guidance

- Alta Planning + Design and IBPI. Bicycle Boulevard Planning and Design Handbook.  
[www.ibpi.usp.pdx.edu/guidebook.php](http://www.ibpi.usp.pdx.edu/guidebook.php)
- City of Berkeley. (2000). Bicycle Boulevard Design Tools and Guidelines.
- AASHTO Guide for the Development of Bicycle Facilities.
- MUTCD.

### Level 3: Bicycle Boulevards at Minor Unsignalized Intersections (7.B.6.c)

#### Design Summary

To encourage use of the boulevard and improve cyclists’ ~~safety~~ sense of security, reduce bicycle travel time by eliminating unnecessary stops and improving intersection crossings.

#### Discussion

##### Stop Sign on Cross-Street

Unmarked intersections are dangerous for bicyclists because cross-traffic may not be watching for cyclists. Stop signs on cross streets require crossing motorists to stop and proceed when ~~safe~~ the intersection has cleared. Stop signs are a relatively inexpensive treatment that is quite effective at minimizing bicycle and cross-vehicle conflicts. However, placing stop signs at all intersections along bicycle boulevards may be unwarranted as a traffic control device.

The DPM specifies that, “Potential on-street bikeway locations should include no more than one stop sign or traffic signal per 1/4 mile. Local street stop control should be reassigned to



Medians on bicycle boulevards can provide space for a bicyclist to wait.



Stop signs effectively minimize conflicts along bicycle boulevards.



Example of a bicycle left-turn pocket.



Bicycle forward stop bars encourage cyclists to wait where they are more visible.

facilitate through bicycle traffic on designated bikeways. Stop control reassignment requires an engineering study to determine additional measures necessary to minimize neighborhood impacts.”

### **Curb Extensions and High-Visibility Crosswalks**

This treatment is appropriate near activity centers with large amounts of pedestrian activity, such as schools or commercial areas. Curb extensions should only extend across the parking lane and not obstruct bicyclists’ path of travel or the travel lane. Curb extensions and high-visibility crosswalks both calm traffic and also increase the visibility of pedestrians waiting to cross the street, although they may impact on-street parking.

### **Bicycle Forward Stop Bar (Non-standard treatment)**

A second stop bar for cyclists placed closer to the centerline of the cross street than the first stop bar increases the visibility of cyclists waiting to cross a street. This treatment is typically used with other crossing treatments (i.e., curb extension) to encourage cyclists to take full advantage of crossing design. They are appropriate at unsignalized crossings where fewer than 25 percent of motorists make a right turn movement.

#### *Guidance*

- Alta Planning + Design and IBPI. Bicycle Boulevard Planning and Design Handbook.
- City of Berkeley. (2000). Bicycle Boulevard Design Tools and Guidelines.
- AASHTO Guide for the Development of Bicycle Facilities.

### ***Level 3: Bicycle Boulevards at Major Unsignalized Intersections (7.B.6.d)***

#### *Design Summary*

Increase crossing opportunities with medians and refuge islands.

#### *Discussion*

### **Medians/Refuge Islands**

A crossing island can be provided to allow cyclists to cross one direction of traffic at a time when gaps in traffic allow. The crossing island should be at least 8 feet wide; narrower medians can accommodate bikes if the holding area is at an acute angle to the major roadway. Crossing islands can be



*Chicanes require all vehicles to reduce their speeds.*



*Traffic circles provide an opportunity for landscaping, but visibility should be maintained.*



*Speed humps are a common traffic calming treatment, which should not be used on emergency routes.*

placed in the middle of the intersection, prohibiting left and through vehicle movements.

#### Guidance

- Alta Planning + Design and IBPI. Bicycle Boulevard Planning and Design Handbook.
- City of Berkeley. (2000). Bicycle Boulevard Design Tools and Guidelines.
- AASHTO Guide for the Development of Bicycle Facilities.

### Level 3: Bike Routes/Boulevards at Offset Intersections (7.B.6.e)

#### Design Summary

- Provide turning lanes or pockets at offset intersection , providing cyclists with a refuge to make a two-step turn.
- Bike turn pockets - 5 feet wide, with a total of 11 feet required for both turn pockets and center striping.

#### Discussion

Offset intersection can be challenging for cyclists, who need to transition onto the busier cross-street in order to continue along the boulevard.

#### Bicycle Left-Turn Lane (Non-standard treatment)

Bicycle left-turn lanes allow the crossing to be completed in two phases. The bicyclist executes a right-hand turn onto the cross-street and then waits in a delineated left-turn lane if necessary. The bike turn pockets should be at least 5 feet wide, total of 11 feet for turn pockets and center striping.

#### Bicycle Left Turn Pocket (Non-standard treatment)

A bike-only left-turn pocket permits bicyclists to make left turns while restricting vehicle left turns. Signs should prohibit motorists from turning. Because of the restriction on vehicle left-turning movements, this treatment also acts as traffic diversion.

#### Guidance

- Alta and IBPI. Bicycle Boulevard Planning and Design Handbook.
- AASHTO Guide for the Development of Bicycle Facilities.

### Level 4: Bicycle Boulevard Traffic Calming (7.B.6.f)

#### Design Summary

Traffic calming treatments reduce vehicle speeds to the point where they generally match cyclists' operating speeds, enabling motorists and cyclists to safely-reasonably co-exist on the same facility.



This bike-only left-turn pocket guides cyclists along a popular bike route.



## Discussion

### Chicanes (Non-standard treatment)

Chicanes are a series of raised or delineated curb extensions on alternating sides of a street forming an S-shaped curb, which reduce vehicle speeds through narrowed travel lanes. Chicanes can also be achieved by establishing on-street parking on alternate sides of the street. These treatments are most effective on streets with narrower cross-sections.

### Mini Traffic Circles

Mini traffic circles are raised or delineated islands placed at intersections, reducing vehicle speeds through tighter turning radii and narrowed vehicle travel lanes (see right). These devices can effectively slow vehicle traffic while facilitating all turning movements at an intersection. Mini traffic circles can also include a paved apron to accommodate the turning radii of larger vehicles like fire trucks or school buses.

### Speed Humps

Shown right, speed humps are rounded raised areas of the pavement requiring approaching motor vehicles to reduce speed. These devices also discourage through vehicle travel on a street when a parallel route exists.

Speed humps should never be constructed so steep that they may cause a bicyclist to lose control of the bicycle or be distracted from traffic. In some cases, a gap could be provided, whereby a bicyclist could continue on the level roadway surface, while vehicles would slow down to cross the barrier.

### Guidance

- Alta Planning + Design and IBPI. Bicycle Boulevard Planning and Design Handbook.  
[www.ibpi.usp.pdx.edu/guidebook.php](http://www.ibpi.usp.pdx.edu/guidebook.php)
- City of Berkeley. (2000). Bicycle Boulevard Design Tools and Guidelines.
- AASHTO Guide for the Development of Bicycle Facilities.

### Level 5: Bicycle Boulevard Traffic Diversion (7.B.6.g)

#### Design Summary

- Traffic diversion treatments maintain through-bicycle travel on a street while physically restricting through vehicle traffic.



Choker entrances prevent vehicular traffic from turning from a main street onto a traffic-calmed bicycle boulevard.



Traffic diverters prevent access to both directions of motor vehicle traffic.

- Traffic diversion is most effective when higher-order streets can sufficiently accommodate the diverted traffic associated with these treatments.

### *Discussion*

#### **Choker Entrances (Non-standard treatment)**

Choker entrances are intersection curb extensions, or raised islands, allowing full bicycle passage while restricting vehicle access to and from a bicycle boulevard. When they approach a choker entrance at a cross-street, motorists on the bicycle boulevard must turn onto the cross-street while cyclists may continue forward. These devices can be designed to permit some vehicle turning movements from a cross-street onto the bicycle boulevard while restricting other movements.

#### **Traffic Diverters (Non-standard treatment)**

Similar to choker entrances, traffic diverters are raised features directing vehicle traffic off the bicycle boulevard while permitting through travel.

#### **Advantages:**

- Provides safe-a protected refuge in the median of the major street so that bicyclists only have to cross one direction of traffic at a time. Works well with signal-controlled traffic platoons coming from opposite directions.
- Provides traffic calming and safety benefits helps to avoid potential conflict by preventing left turns and/or through traffic from using the intersection.

#### **Disadvantages:**

- Potential motor vehicle impacts to major roadways, including lane narrowing, loss of some on-street parking and restricted turning movements.
- Crossing island may be difficult to maintain and may collect debris.

### *Guidance*

- Alta Planning + Design and IBPI. Bicycle Boulevard Planning and Design Handbook. [www.ibpi.usp.pdx.edu/guidebook.php](http://www.ibpi.usp.pdx.edu/guidebook.php)
- City of Berkeley. (2000). Bicycle Boulevard Design Tools and Guidelines.
- AASHTO Guide for the Development of Bicycle Facilities.

## 6.7. Innovative Bike Lane Treatments

### ***Bike Box (7.B.7.a)***

#### *Design Summary*

Bike Box Dimensions:

- 14 feet deep to allow for bicycle positioning.

Signage: Appropriate signage as recommended by the MUTCD applies. Signage should be present to prohibit right turn on red and to indicate where the motorist must stop.

#### *Discussion*

A bike box is generally a right angle extension of a bike lane at the head of a signalized intersection. The bike box allows bicyclists to move to the front of the traffic queue on a red light and proceed first when that signal turns green. Motor vehicles must stop behind the white stop line at the rear of the bike box.

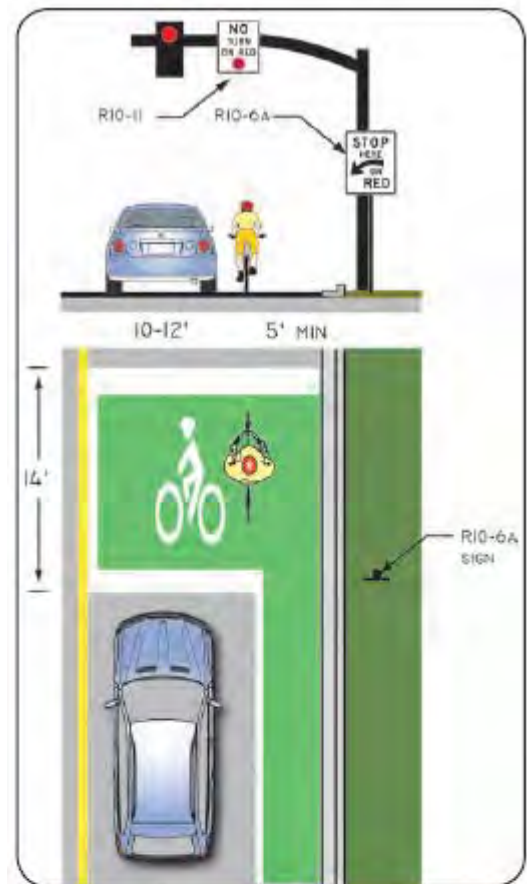
Bike boxes can be combined with dashed lines through the intersection for green light situations to remind right-turning motorists to be aware of bicyclists traveling straight, similar to the colored bike lane treatment described earlier. Bike boxes can be installed with striping only or with colored treatments to increase visibility. Use of coloration substantially increases costs of maintenance over uncolored (striping, bicycle symbol and text only) treatments.

Bike boxes should be located at signalized intersections only and right turns on red should be prohibited. Bike boxes should be used locations that have a large volume of cyclists and are often utilized in central areas where traffic is usually moving slowly. Reducing right turns on red improves **safety** ~~for~~ cyclists' **environment** and does not significantly impede motor vehicle travel.

On roadways with one travel lane in each direction, the bike box also facilitates left turning movements for cyclists.

#### *Guidance*

*Evaluation of Innovative Bike-Box Application in Eugene, Oregon*, Author: Hunter, W.W., 2000



Recommended bike box design.



Bike boxes have been installed at several intersections in Portland, OR where right-turning motorists conflict with through bicyclists.



### ***Shared Bicycle/Bus Lane (7.B.7.b)***

#### ***Design Summary***

Provide a standard width bike lane (minimum 4 feet) where possible.

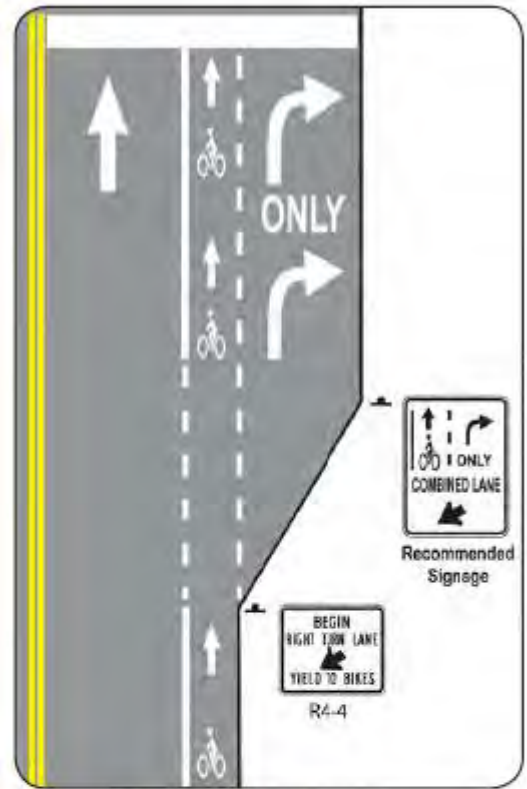
Paint bicycle symbol or shared lane marking symbol to the left side of the bus lane to allow bicyclist to pass a bus that has turned in at a stop.

#### ***Discussion***

The shared bus/bicycle lane should be used where width is available for a bus lane, but not a bus and bike lane. The dedicated lane attempts to reduce conflicts between bicyclists, buses and automobiles. Various cities have experimented with different designs and there is currently no evidence of one design being more effective than the others.

Shared bike/bus lanes can be appropriate in the following applications:

- On auto-congested streets and moderate or long bus headways.
- Moderate bus headways during peak hours.
- No reasonable alternative route.



*Recommended shared bike/right turn lane design.*



*Shared bike-right turn lanes require warning signage as well as pavement markings.*

## Shared Bike/Right Turn Lane (7.B.7.c)

### Design Summary

#### Width:

- Shared turn lane – minimum 12 feet width.
- Bike lane pocket – minimum 4-5 feet preferred.

### Discussion

This treatment is recommended at intersections lacking sufficient space to accommodate a standard bike lane and right turn lane. The shared bicycle/right turn lane places a standard-width bike lane on the left side of a dedicated right turn lane. A dashed strip delineates the space for bicyclists and motorists within the shared lane. This treatment includes signage advising motorists and bicyclists of proper positioning within the lane.

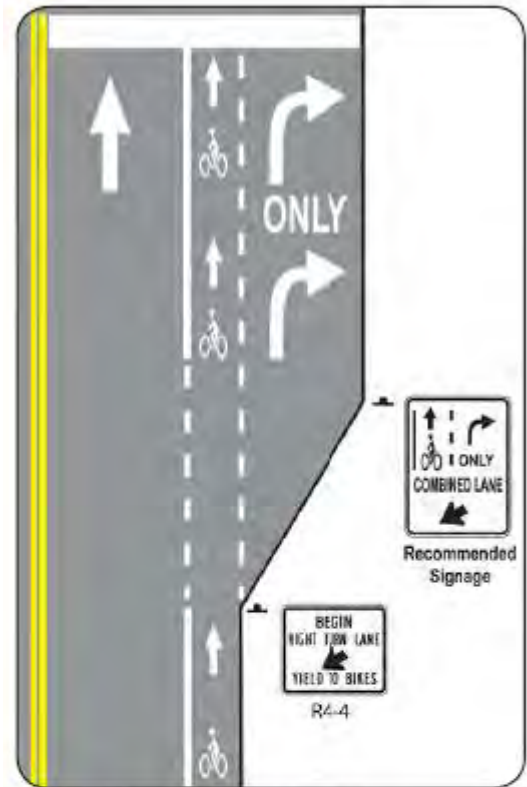
Case studies cited by the Pedestrian and Bicycle Information Center indicate that this treatment works best on streets with lower posted speeds (30 mph or less) and with lower traffic volumes (10,000 ADT or less).

#### Advantages:

- Aids in correct positioning of cyclists at intersections with a dedicated right turn lane without adequate space for a dedicated bike lane.
- Encourages motorists to yield to bicyclists when using the right turn lane.
- Reduces motor vehicle speed within the right turn lane.
- Disadvantages/potential hazards:
- May not be appropriate for high-speed arterials or intersections with long right turn lanes.
- May not be appropriate for intersections with large percentages of right-turning heavy vehicles.

### Guidance

This treatment has coverage in the draft 2009 AASHTO *Guide for the Development of Bicycle Facilities*. It has been previously implemented in San Francisco, Calif., and Eugene, Ore.



Recommended shared bike/right turn lane design.



Shared bike-right turn lanes require warning signage as well as pavement markings.

## Colored Bike Lanes

### Design Summary

- Bike lane pocket – minimum 4-5 feet preferred.
- Use colored pavement through entire merge area.
- Dashed lines can be used to indicate that automobiles are crossing the bike lane.
- Signage reminds drivers to yield to cyclists in the bike lane.

### Discussion

Cyclists are especially vulnerable at locations where the volume of conflicting vehicle traffic is high and where the vehicle/bicycle conflict area is long. Some cities are using colored bike lanes to guide cyclists through major vehicle/bicycle conflict points. These conflict areas are locations where motorists and cyclists must cross each other's path (e.g., at intersections or merge areas). Colored bike lanes typically extend through the entire bicycle/vehicle conflict zone (e.g., through the entire intersection) or through the transition zone where motorists cross a bike lane to enter a dedicated right turn lane.

There are three colors commonly used in bike lanes: blue, green and red. Several cities initially used blue; however, this color is associated with amenities for handicapped drivers or pedestrians. Green is the color recommended for use in Albuquerque.

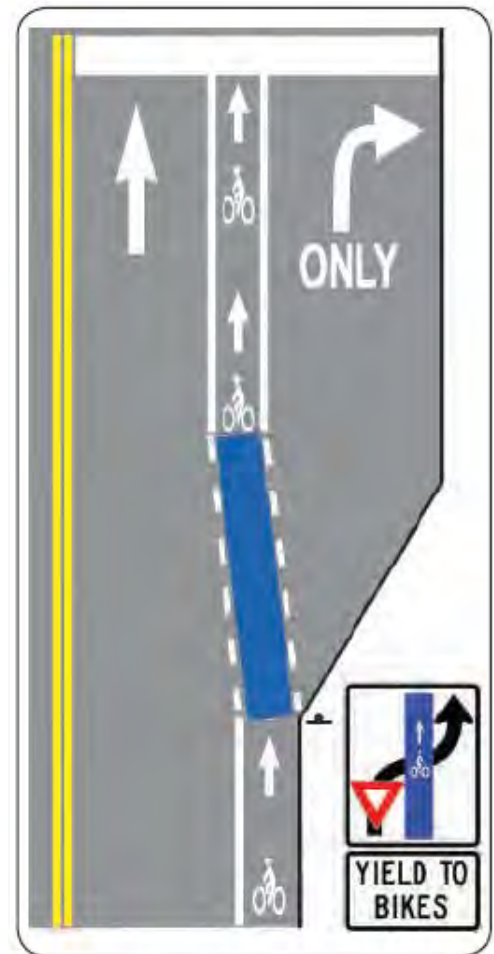
Advantages of colored bike lanes at conflict points:

- Draws attention to conflict areas
- Increases motorist yielding behavior
- Emphasizes expectation of bicyclists on the road.

### Guidance

Although colored bike lanes are not an official standard at this time, they continue to be successfully used in cities, including Portland, Ore.; Philadelphia, Pa.; Cambridge, Mass.; Toronto, Ontario; Vancouver, B.C.; and Tempe, Ariz. This treatment typically includes signage alerting motorists of vehicle/ bicycle conflict points. Portland's Blue Bike Lane report found that significantly more motorists yielded to bicyclists and slowed or stopped before entering the conflict area after the application of the colored pavement.

Additional information in Portland Office of Transportation (1999). Portland's Blue Bike Lanes: Improved Safety through Enhanced Visibility. Available: [www.portlandonline.com/shared/cfm/image.cfm?id=58842](http://www.portlandonline.com/shared/cfm/image.cfm?id=58842)



Recommended colored bike lane design.



Portland, OR has implemented colored bike lanes.



## Buffered Bike Lanes

### Design Summary

Guidelines for buffer width varies:

- 2.6 feet/80 centimeters (London and Brussels)
- 1.6-2.5 feet/50-75 centimeters (CROW Guide)
- 6 feet (Portland, Ore.)

### Discussion

Bike lanes on high-volume or high-speed roadways can be dangerous or uncomfortable for cyclists, as automobiles pass or are parked too close to bicyclists. Buffered bike lanes are designed to increase the space between the bike lanes and the travel lane or parked cars.

This treatment is appropriate on bike lanes with high automobile traffic volumes and speed, bike lanes adjacent to parked cars and bike lanes with a high volume of truck or oversized vehicle traffic. Frequency of right turns by motor vehicles at major intersections should determine whether continuous or truncated buffer striping should be used approaching the intersection.

Advantages of buffered bike lanes:

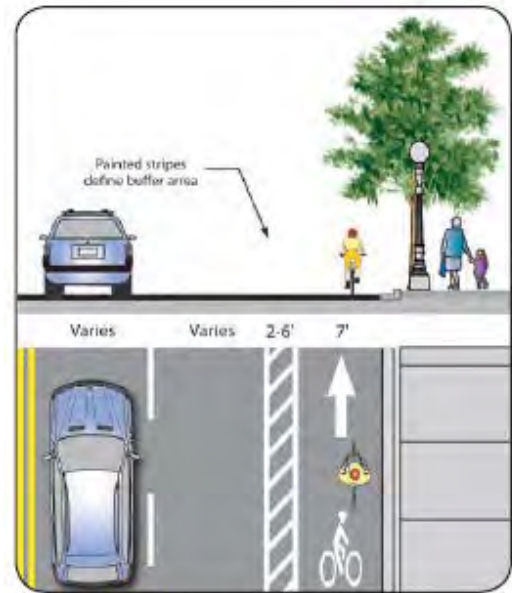
- Provides cushion of space to mitigate friction with motor vehicles on streets with narrow bike lanes.
- Provides space for cyclists to pass one another without encroaching into the travel lane.
- Provides space for cyclists to avoid potential obstacles in the bike lanes, including drainage inlets, manholes, trash cans or debris.
- Parking side buffer provides cyclists with space to avoid the door zone of parked cars.
- Provides motorists greater shy distances from cyclists in the bike lane.

Disadvantages/potential hazards:

- Requires additional roadway space.
- Requires additional maintenance for the buffer striping.
- Frequency of parking turnover should be considered prior to installing buffered bike lanes.
- Increases the debris collection in the bike lane.

### Guidance

This treatment is not currently present in any state or federal design standards. The City of Portland, Ore., included this treatment in the Bikeway Design Best Practices for the 2030 Bicycle Master Plan. Buffered bike lanes are currently also used in Brussels & Bruges, Belgium, Budapest, Hungary, London, U.K., Seattle, Wash., San Francisco, Calif., and New York, N.Y.



Recommended buffered bike lane design.



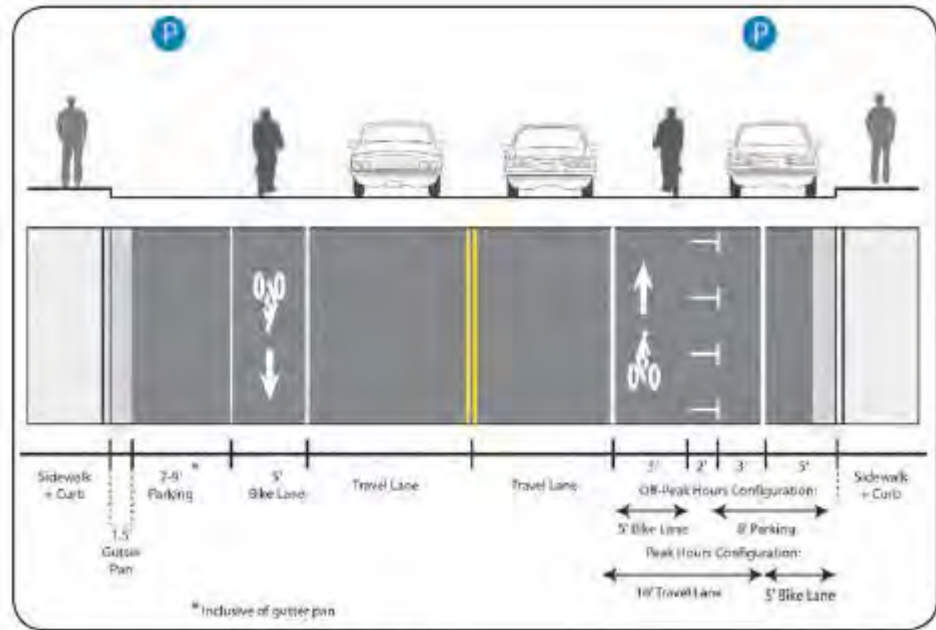
Buffered bike lanes protect cyclists from fast-moving traffic.

## Floating Bike Lanes

### Design Summary

It is important to provide adequate space to minimize the risk of “doorings” when parking is permitted. The bicycle symbol may be used curbside or sharrow markings in lieu of bike lane striping.

In San Francisco, parking is permitted during off-peak times: 9 a.m.-3 p.m. and 7 p.m. to 7 a.m.



Recommended floating bike lane design.

### Discussion

This treatment maintains the bicycle facility when an extra travel lane (for automobiles) is added during peak hours. A single lane can function as a parking lane or an exclusive bike lane. During peak hours, parking is not allowed and cyclists use a curbside bike lane. During off-peak hours, cyclists travel in the space between the motorized traffic lane and parked cars. This treatment can be used on primary bike routes during peak hours or on streets warranting bike lanes with high parking demand where there is insufficient space to provide both standard bike lane and parking.



Floating bike lane when parking is allowed on The Embaradero, San Francisco. Source: sfmta.org

Advantages of buffered bike lanes:

- Can accommodate bicycles at all times, even when parking is permitted.
- Provides bicycle facilities on streets with constrained rights-of-way.

Disadvantages/potential hazards

- Unorthodox design can be confusing to both cyclists and motorists.
- Enforcement is required.

### Guidance

This treatment is not currently present in any state or federal design standards. The City of Portland, Ore., included this treatment in the Bikeway Design Best Practices for the 2030 Bicycle Master Plan. Floating bike lanes are currently used in San Francisco, Calif.

## Contraflow Bike Lane

### Design Summary

- The contraflow lane should be 5-6.5 feet and marked with a solid double yellow line and appropriate signage.
- Bike lane markings should be clearly visible to ensure that contraflow lane is exclusively for bicycles.
- Coloration should be considered on the bike lane.

### Discussion

Contraflow bike lanes provide bi-directional bicycle access along a roadway that is one-way for automobile traffic. This treatment can provide direct access and connectivity for bicyclists, avoiding detours and reducing travel distances for cyclists.

Advantages of contraflow bike lanes:

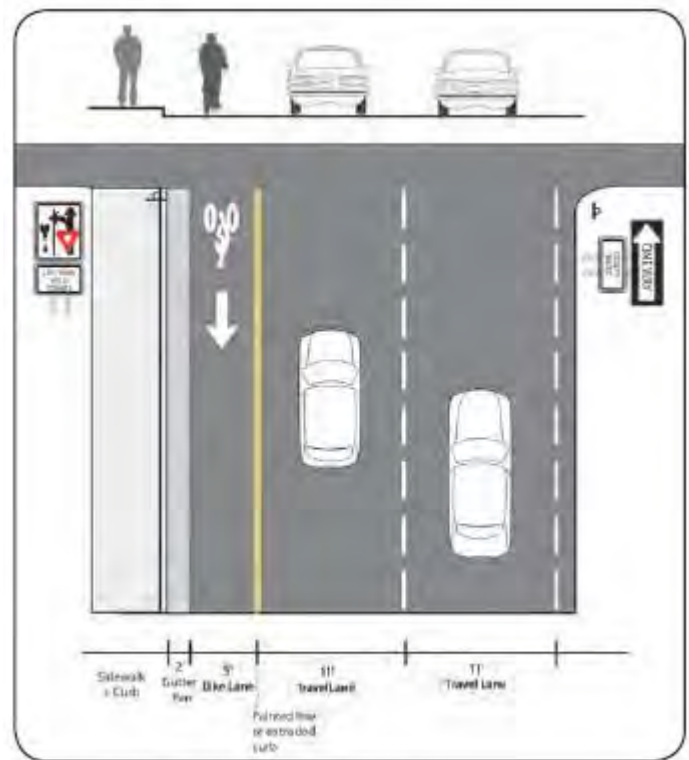
- Provides direct access and connectivity for bicycles traveling in both directions.
- Influences motorist choice of routes without limiting bicycle traffic.
- Cyclists do not have to make detours as a result of one-way traffic.

Disadvantages/potential hazards:

- Parking should not be provided on the far side of the contraflow bike lane.
- Space requirements may require reallocation of roadway space from parking or travel lanes.
- The lane could be illegally used by motorists for loading or parking.
- Conversion from a two-way street requires elimination of one direction of automobile traffic
- Public outreach should be conducted prior to implementation of this treatment.

### Guidance

This treatment is a federally-recognized design standard and present in some state Department of Transportation manuals, such as the Wisconsin Bicycle Facility Design Handbook. The City of Portland, Ore., included this treatment in the Bikeway Design Best Practices for the 2030 Bicycle Master Plan. Contraflow bike lanes are currently used in Olympia, Wash.; Seattle, Wash.; Madison, Wis.; Cambridge, Mass.; San Francisco, Calif.; and Portland, Ore.



Recommended contraflow bike lane design.



This contraflow bike lane in Portland, OR (left) provides a key connection along a narrow one-way street.



## 8. Cycle Tracks

### *Design Summary*

A cycle track is an exclusive bicycle facility that combines the user experience of a separated path with the on-street infrastructure of a conventional bike lane. Recommended cycle track width:

- 7 foot minimum to allow passing.

### *Discussion*

Cycle tracks provide space that is intended to be exclusively or primarily for bicycles and are separated from vehicle travel lanes, parking lanes and sidewalks. Cycle tracks can be either one-way or two-way, on one or both sides of a street and are separated from vehicles and pedestrians by pavement markings or coloring, bollards, curbs/medians or a combination of these elements.

### **Cycle tracks provide:**

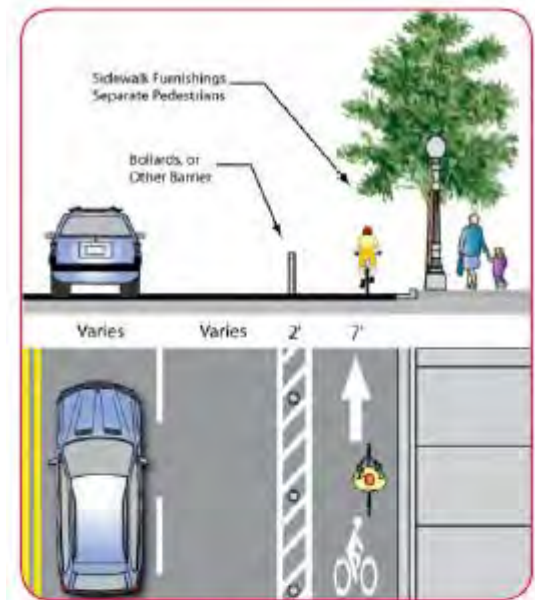
- Increased comfort for bicyclists.
- Greater clarity about expected behaviour.
- Fewer conflicts between bicycles and parked cars as cyclists ride inside the parking lane.
- Space to reduce the danger of car dooring.

Danish research has shown that cycle tracks can increase bicycle ridership 18-20 percent, compared with the 5-7 percent increase associated with bike lanes.

### **However, disadvantages of cycle tracks include:**

- Increased vulnerability at intersections.
- Regular street sweeping trucks cannot maintain the cycle track. Requires smaller sweepers.
- Conflicts with pedestrians and bus passengers can occur, particularly on cycle tracks that are undifferentiated from the sidewalk or that are between the sidewalk and a transit stop.

Cycle tracks should be placed along slower speed urban/suburban streets with long blocks and few driveways or mid-block access points for vehicles. Cycle tracks located on one-way streets will have fewer potential conflicts than those on two-way streets. A two-way cycle track is desirable when there are more destinations on one side of a street or if the cycle track will connect to a shared-use path or bicycle facility on one side of the street.



*Recommended cycle track design without parking, using striping and flexible bollard separation.*



*Recommended cycle track design with on-street parking.*

## Guidance

While only recently implemented in U.S. and Canadian cities, cycle tracks have been used in European countries for several decades. The cycle track design guidance was developed using best practices from European experience, as well as New York City, Montreal and Portland, Ore. Additional guidance: Cycle Tracks: Lessons Learned, Alta Planning + Design (2009).

[www.altaplanning.com/App\\_Content/files/pres\\_stud\\_docs/Cycle%20Track%20lessons%20learned.pdf](http://www.altaplanning.com/App_Content/files/pres_stud_docs/Cycle%20Track%20lessons%20learned.pdf)

## Cycle Track Separation

### Design Summary

Cycle tracks can be separated from vehicle traffic by a barrier or through grade-separation. Physical barriers can include bollards, parking, a planter strip, an extruded curb or parking. Cycle tracks using barrier separation typically share the same elevation as adjacent travel lanes. Pavement markings or other minimal separation should designate pedestrian space and discourage pedestrians from walking in the cycle track. Openings in the barrier or curb are needed at driveways or other access points. Grade-separated cycle tracks should incorporate a rolled curb, which allows cyclists to enter or leave the cycle track at will and enables motorists to cross the cycle track at intersections and crossings.

### Discussion

#### Parking Placement

Where on-street parking exists, the cycle track should be placed between the parking and the sidewalk. The cycle track should be placed with a 2-foot buffer between parking and the sidewalk to minimize the hazard of dooring cyclists. Drainage inlets should be provided adjacent to the sidewalk curb to facilitate run-off. This technique is common in Copenhagen, as pictured right.

#### Channelization

Cycle tracks can be at street-level, provided that there is a physical separation. The curb creates the separated space, as well as preventing passengers from opening doors into the cycle track and discouraging pedestrians from walking on the facility.

#### Mountable Curb

Cycle tracks can be grade-separated from the roadway. The cycle track should be 2 or 3 inches above street-level, and the sidewalk should be an additional 2 to 3 inches above that.



Cycle track with a parking buffer, Copenhagen.



Cycle track with curb separation, Amsterdam.



Mountable curb, Copenhagen.



Cycle track with bollard separation, New York City.

Where cyclists may enter or leave the cycle track or where motorists cross at a driveway, the curb should be mountable with a small ramp, allowing cyclist turning movements.

### **Bollards and Pavement Markings**

In addition to grade separation or channelization, the cycle track should have signage, pavement markings and/or different coloration or texture to indicate that the facility is provided for bicycle use. Signage, in addition to flexible bollards, can add to the physical separation of the facility, shown in this example from Melbourne, Australia.

#### *Guidance*

A buffer is not required of a cycle track wider than 7 feet, but is recommended where possible. The CROW Design Manual for Bicycle Traffic recommends that the buffer area inside built-up areas should be a minimum of 1.1 feet. If the buffer is a fence or other taller obstacle, a minimum of 2 feet shy distance is recommended on either side.

### **Cycle Track Intersection Treatments**

Cycle tracks separate cyclists and motor vehicles to a greater degree than bike lanes. This leads to added comfort for cyclists on the cycle track, but it creates additional considerations at intersections that must be addressed. A right-turning motorist conflicting with cycle track users represents the most common conflict. Both roadway users have to expand their visual scanning to see potential conflicts.

#### *Cycle Track Treatments at Driveways and Minor Street Crossings*

##### *Design Summary*

Recommendations for increasing bicyclist visibility at driveways and minor street crossings:

- Maintain height level of cycle track, requiring automobiles to cross over.
- Remove parking 16 feet prior to the intersection.
- Use colored pavement markings through the conflict area.
- Place warning signage to identify the crossing (see page 5).

##### *Discussion*

At driveways and crossings of minor streets, the majority of traffic will continue through intersections, while a small



*Cycle tracks should be continued through driveway crossings, improving visibility.*



*Colored pavement informs bicyclists and drivers of a potential conflict area.*



*Bicycle markings at a driveway crossing.*



number of automobiles will cross the cycle track. At these locations, cyclist visibility is important, as a buffer of parked cars or vegetation can hide a cyclist traveling in the cycle track.

Cyclists should not be expected to stop at these minor intersections if the major street does not stop, and markings and signage should be used to indicate that drivers should watch for cyclists.

Access management should be used to reduce the number of crossings of driveways on a cycle track.

### *Guidance*

See the CROW Design Manual for Bicycle Traffic or Cycle Tracks: Lessons Learned, Alta Planning + Design (2009) for additional guidance.

[www.altaplanning.com/App\\_Content/files/pres\\_stud\\_docs/Cycle%20Track%20lessons%20learned.pdf](http://www.altaplanning.com/App_Content/files/pres_stud_docs/Cycle%20Track%20lessons%20learned.pdf)

### *Cycle Track Treatments at Major Street Crossings*

#### *Design Summary*

Recommendations for increasing bicyclist visibility at major street crossings:

- Stripe stop line 16 feet back from the intersection.
- Remove parking 16 feet prior to the intersection.
- Drop cycle track to bike lane 16 feet back from intersection.
- Use bike box treatments to move cyclists in front of traffic (see page 2).
- Use colored pavement markings through the conflict area.

### *Discussion*

Protected phases at signals or scramble signals separate automobile turning movements from conflicting through-bicycle movements. Bicycle signal heads ensure that all users know which signals to follow. Demand-only bicycle signals can require user actuation and reduce vehicle delay by



*Cycle track dropping to bike lane before an intersection.*



*Crossings should separate space for bicyclists and pedestrians.*



*At this unsignalized right turn, the cycle track has dropped to a bike lane with blue coloration and pavement markings through the conflict area.*



*Bike-specific signals are small and placed on the near-side of traffic.*

preventing an empty signal phase from regularly occurring.

Advanced signal phases can be set to provide cycle track users an advanced green phase. This places cyclists in front of traffic and allows them to make their turning movements without merging into traffic.

An advanced warning allows bicyclists to prepare to move forward through the intersection. This warning can be accomplished through a pre-green interval, a yellow warning display two seconds before the green or a bicycle countdown signal.

### *Guidance*

The CROW guide states that if the speed of the main street is 45 mph or less, the cycle track should turn inwards prior to crossing a side street. This is to improve visibility of cyclists to motorists in the main road turning right. If the speed is greater, the cycle track should bend away from the main road at intersections so that vehicles leaving the main road can stack up on the cross street between the cycle track and the main road. Signage should also warn motorists of the crossing.

### *Left Turn Movements*

#### *Design Summary*

Left turn opportunities for cyclists can be provided in the following ways:

- Copenhagen lefts are a two-stage crossing, which include a turning and waiting area at the far side of the first intersection.
- Box lefts are pockets where bicyclists can move to the right hand side of the cycle track and wait for a crossing signal. This treatment can result in the cyclist being on the wrong side of the street in a standard four-way intersection.
- Scramble signals.

#### *Discussion*

Bicyclists are often not allowed to make left-turn movements from the cycle track can be physically barred from moving into



*Left-turn from a cycle track on the right via bicycle-signal phase in Stockholm, Sweden.*



*"Copenhagen Left" application.*



*"Box left" turn in Troisdorf, Germany.*

the roadway by the cycle track barrier.

The “Copenhagen Left” (also known as the “Melbourne Left,” the “jug-handle turn” and the “two-stage left”) is a way of enabling a safe left-turn movement by bicyclists in a cycle track. Bicyclists approaching an intersection can make a right into the intersecting street from the cycle track to position themselves in front of cars. Bicyclists can go straight across the road they were on during next signal phase. All movements in this process are guided by separate traffic signals. Motorists are not allowed to make right turns on red signals. In addition, motorists have an exclusive left-turn phase in order to make their movements distinct from the bicyclists’.

### Guidance

See the CROW Design Manual for Bicycle Traffic or Cycle Tracks: Lessons Learned, Alta Planning + Design (2009) for additional guidance.

[www.altaplanning.com/App\\_Content/files/pres\\_stud\\_docs/Cycle%20Track%20lessons%20learned.pdf](http://www.altaplanning.com/App_Content/files/pres_stud_docs/Cycle%20Track%20lessons%20learned.pdf)

### Two-Way Cycle Tracks

#### Design Summary

- 12 foot minimum to allow passing. Fourteen-foot recommended (New York City).
- Striped center line to separate traffic.
- Pavement markings should indicate direction.

#### Discussion

A two-way cycle track is desirable when more destinations are on one side of a street (therefore preventing additional crossings) if the facility connects to a path or other bicycle facility on one side of the street or if there is not enough room for a cycle track on both sides of the road.

#### **Bidirectional cycle tracks are acceptable in the following situations:**

- On a street with few intersections or without access on one side (e.g., along a waterway or rail line).
- On a one-way street with fewer than one intersection every 100 feet.
- On two-way streets where left-hand turns are prohibited and with a limited number of intersections and driveway entrances.



Two-way cycle track with dividing line.



Directional markings on cycle track.



Pavement markings indicate travel direction at a minor roadway crossing on this cycle track in Paris, France.



Parking should be banned along the street with the bike path to ensure adequate stopping sight distances for motorists crossing the path.

Two-way cycle tracks have many similar design characteristics as one-way tracks: they are physically divided from cars and pedestrians and require similar amenities at driveway and side-street crossings.

Two-way cycle tracks require a higher level of control at intersections to allow for a variety of turning movements. These movements should be guided by a separated signal for bicycles and for motor vehicles. Transitions onto bidirectional cycle tracks should be simple and easy to use to deter bicyclists from continuing to ride against the flow of traffic.

In addition, bicyclists riding against roadway traffic in two-way cycle tracks may surprise pedestrians and drivers at intersections.

### *Guidance*

Vélo Québec Technical Handbook of Bikeway Design. (2003), CROW Design Manual for Bicycle Traffic and Alta Planning + Design Cycle Tracks: Lessons Learned, (2009).

## **CD. Trail Design**

### **1. Background Information**

In 1981, the American Association of State Highway and Transportation Officials (AASHTO) first attempted to create a comprehensive set of guidelines for accommodating bicyclists in various riding environments. Although it was not intended to set forth strict standards, the AASHTO Guide for the Development of Bicycle Facilities (revised in 1991, 1999, and the current 2012 fourth edition) has been the predominant source of information in this area although no enforceable Federal standards exist.

While most states have deferred to AASHTO's guidelines as de-facto design standards since 1981, some state and local governments are leading the way in the production of their own standards and guidelines in order to address local issues and meet the current needs of pedestrians, bicyclists, equestrians, and other user groups. In 1992, the U.S. Department of Transportation and the Federal Highway Administration conducted a national bicycling and walking survey entitled Case Study No. 24, Current Planning Guidelines and Design Standards Being Used by State and Local Agencies for Bicycle and Pedestrian Facilities. That study was followed in 1999 by a similar, but broader effort entitled Designing Sidewalks and Trails, Part 1: Review of Existing Guidelines and Practices. By compiling and listing a number of examples of state and local guidelines, these documents identified models to which other communities could refer when developing their own bicycle and pedestrian plans, as guides to the state of the practice. (Part 2 of the 1999 FHWA study summarizes the earlier findings in a "best practices" guide, described more fully below.)

Until recently, bicycle-related [safety issues-protection measures](#) (such as appropriate widths, turning radii, sight distances, and avoiding conflicts with vehicular traffic) have been the dominant trail design

concerns. While these remain vital concerns, the presence of accepted standards such as the AASHTO guidelines have led to a shift in focus toward providing more “inclusive” and accessible outdoor recreational settings, especially in the urban environment. Rather than focusing solely on the cyclist and/or pedestrian, our collective awareness has been broadened to include all types of users, including children, parents with strollers, equestrians, people in wheelchairs, vision impairments, and those with other impairments or physical challenges. It is relatively easy to design for one or two user groups; however, it is extremely challenging to design multi-use trails that will be perfect for every user group.

### ***ADA Guidelines (7.C.1.a)***

The Americans with Disabilities Act of 1990 (ADA) prohibits discrimination and ensures equal opportunity for persons with disabilities in employment, State and local government services, public accommodations, commercial facilities, and transportation. It also mandates the establishment of TDD/telephone relay services. The current text of the ADA includes changes made by the ADA Amendments Act of 2008 (P.L. 110-325), which became effective on January 1, 2009 and is now accompanied by the 2010 ADA Standards for Accessible Design. Together they provide national accessibility regulations for buildings and related urban environments. However, when designing outdoor recreational facilities or multi-use trails (with the exception of facilities built on Federal Land), the application of strict ADA standards often proves impractical and currently lacks any Federal ruling or legal requirement. There is practical design and smart practices that can and should be followed when building multi-use trail and trailhead facilities. These will be followed until the Federal government adopts a ruling for requirements that shall be followed. The following is some history on how practical design and smart practice came to be.

In 1993, the nonprofit organization Project Play and Learning in Adaptable Environments, Inc., (PLAE), in partnership with the USDA Forest Service and a number of other agencies and organizations, took the initiative to develop guidelines and published *Universal Access to Outdoor Recreation: A Design Guide*. By acknowledging a desire for various levels of recreational challenge and related facility development in settings ranging from highly-developed urban to primitive, natural landscapes, this book pioneered the way for designers to address the needs of people of all abilities in outdoor recreation and provides a universal approach to outdoor design in the spirit of ADA regulations. However, as comprehensive as it is, the PLAE design guide does not yet enjoy the support of law, such as ADAAG.

To address this, the U.S. Architectural and Transportation Barriers Compliance Board (a.k.a. the “Access Board” -- the agency which administers and develops accessibility design guidelines) formed the Recreation Access Advisory Committee (RAAC) to study the issues and develop federal standards for outdoor recreational facilities. Based in part on the research and recommendations of the PLAE partnership in *Universal Access to Outdoor Recreation*, the RAAC published draft *Recommendations for Accessibility Guidelines: Recreational Facilities and Outdoor Developed Areas* in 1994 but could not reach consensus on many issues. Public comment also demonstrated a lack of consensus, especially

regarding trails accessibility. In 1997 the Access Board created the Outdoor Developed Areas Regulatory Negotiation Committee (RNC), with representation by people with disabilities, state, federal and local land management agencies, trails groups, designers, and owners/operators of various “outdoor developed areas.” After careful examination of the previous work done by RAAC, and the solicitation of input from the public, a final report was submitted by the RNC to the Access Board in September of 1999 2013 (available at <http://www.access-board.gov/guidelines-and-standards/recreation-facilities/outdoor-developed-areas/final-guidelines-for-outdoor-developed-areas>~~http://www.access-board.gov/outdoor/outdoor-rec-rept.htm~~). The report gives recommendations on accessibility issues related to outdoor recreation access routes, beach access, picnic elements, and camping facilities.

The 2000 Census shows that 20% or approximately 54 million U.S. Citizens over the age of 15 have a disability. Also, 17 million Americans have serious hearing disabilities (2000 Census). There are three times more people with severe vision impairments than there are wheelchair users and information is a barrier for people with vision disabilities.

The newest and most comprehensive guidelines that can and should be used when designing multi-use trails is called Public Rights of Way Accessibility Guidelines (PROWAG). These guidelines were originally intended to supplement the ADAAG to provide standards specific to public rights-of-way. Applicable to new construction and alterations of existing facilities within the public right-of-way excluding shared-use paths or multi-use trails. As an enforceable standard, PROWAG provides the best guidelines for multi-use trail design and should be followed until there is specific guidelines enforceable for multi-use trails. When designing multi-use trails for ADA, the two main barriers of people with disabilities should be remembered. Movement and information are two major barriers for people with disabilities. People with mobility disabilities may have limited agility, speed, endurance and may benefit from designers implementing firm level surfaces, curb ramps where needed, and limited cross slopes. People with vision impairments from complete blindness to partial vision tend to benefit from sounds, textures, and contrasts such as audible/vibrotactile crossing information, tactile indication of boundary between pedestrian and vehicular roadways, clearly defined pathways, and high color contrasts. People with hearing disabilities rely on vision and benefit from good sight lines for assessing street crossing conditions, information in the visual, and information in a visual or vibrotactile format. Persons with cognitive disabilities have different processing and decision-making skills and benefit from straightforward, and direct environments, uncomplicated street crossings, and easy to understand symbols. Therefore, the design of multi-use trails should try and accommodate a broad spectrum of users and enable users to travel independently as much as possible.

### ***FHWA Best Practices Guidelines (7.C.1.b)***

In 2001 the FHWA issued the latest in its series of technical guides intended to help designers at the state level more easily integrate bicycle and pedestrian projects into mainstream transportation projects. Designing Sidewalks and Trails for Access, Part 2: Best Practices Design Guide followed their earlier



compendium of existing guidelines and practices (described above). According to the transmittal letter which accompanied the initial distribution of the Best Practices Design Guide, “its aim was to develop tools to help the FHWA, and State and local governments meet their responsibilities under Title II [of the Americans with Disabilities Act of 1990] and Section 504 [of the Rehabilitation Act of 1973], while reducing their vulnerability to complaints filed under the ADA. The guide reflects recognized “best practices” in effect at the time of publication, and also incorporates recommendations from the Access Board’s 1999 final report from the Regulatory Negotiation Committee on Accessibility Guidelines for Outdoor Developed Area (described above).

### ***State and Local Efforts (7.C.1.c)***

The City of Albuquerque’s efforts to address trail implementation date back to 1973, when an advisory committee began research for The Bikeway Study, which was published the following year. That document marked Albuquerque’s first bicycle network plan, which evolved into the Long Range Bikeway System maps currently published by Mid-Region (formerly Middle Rio Grande) Council of Governments (MRCOG). In the early ‘80s, the Albuquerque/Bernalillo County Comprehensive Plan reaffirmed the City’s dedication to implementing a multi-purpose trails network.

Other local documents created in the mid-1980s to the early ‘90s began to address trail design issues specific to Albuquerque. The 1986 Facility Plan for Arroyos, for example, promotes the use of the city’s numerous drainage features for urban recreational purposes. A number of Arroyo Corridor Plans further carry out the multi-use trail goals stated in the Facility Plan. The Bear Canyon Arroyo Corridor Plan, San Antonio Arroyo Corridor Plan, Amole Arroyo Corridor Plan, and Pajarito Arroyo Corridor Plan have been adopted by the City and contain varying levels of design guidelines for implementing specific types of trails. Several other corridors, including the City’s two largest arroyos, the Calabacillas and Tijeras, have been the subjects of similar studies, which have not yet been adopted.

In 1989, the City Council adopted Bill No. 0-133 establishing a Greater Albuquerque Recreational Trails Committee (GARTC), which serves as the off-road counterpart to the Greater Albuquerque Bicycling Advisory Committee (GABAC), providing a voice for the trail-user and cycling communities in City government. In conjunction with the City’s Planning Department, GARTC began research for a “Master Recreational Trails Plan” shortly after its formation. This process resulted in the 1993 Trails & Bikeways Facility Plan, which represents the city’s most comprehensive trails planning document to date (plan maps updated in 1996).

In 1996, the New Mexico State Highway and Transportation Department (NMSHTD – now NMDOT) produced the first state-wide New Mexico Bicycle-Pedestrian-Equestrian (BPE) Transportation Plan. Developed partially in fulfillment of federal mandates under the Intermodal Surface Transportation Efficiency Act of 1991 (ISTEA), the plan provides general guidance in the development of bikeways, walkways, and equestrian trails. Three appendices include some design standards, applicable state laws,

and trail-related signing and striping excerpts from the Manual on Uniform Traffic Control Devices (MUTCD). The recommendations in the plan are “loosely categorized” according to an emerging national convention called the “4-E” approach, which emphasizes the four functional areas of engineering, education, enforcement, and encouragement in promoting and implementing successful BPE programs. The state plan was revised in 1999, 2001, and 2003. Currently, the NMDOT has begun a comprehensive and collaborative process to develop a 2040 Statewide Long-Range Multimodal Transportation Plan (SLRP). The plan will provide a vision for how New Mexico’s transportation system can support the well-being of our residents and visitors now and in the future.

#### ***Current Directions (7.C.1.d)***

The various local documents concerning Albuquerque trails have provided the first stages in trail design guidance based upon needs of individual user groups. However, they fall short in providing adequate guidelines for implementing a multi-purpose network that will accommodate all potential users. Many were oriented primarily toward bicycles, while those which addressed multiple users tended to focus on separate single-use facilities.

In the greater Albuquerque area, as is true throughout the nation, finding solutions to the wants and needs of multiple user groups is increasingly challenging. It is simply not feasible in most cases to provide separate facilities for each of the various use types. Acquiring sufficient right-of-way to provide adequate widths and safe-necessary separations for multiple, parallel trails is cost prohibitive, at best, and is often not even possible within developed portions of the city. The City of Albuquerque has adopted the strategy of accommodating multiple user groups with the design and construction of multi-use trails.

#### ***Designing for Multiple-Use (7.C.1.e)***

The concept of combining user groups on single trail facilities is not without its difficulties. Multi-purpose trail design is faced with the challenge of allowing for the freedom of choice essential to a satisfactory outdoor recreation experience, on one hand, while at the same time minimizing conflicts between different trail users. In order for multi-use trails to function effectively, the various user groups need to be cognizant and respectful of the needs of other users. Public education is an important element in reducing conflicts often associated with multi-use trails.

A number of studies have been undertaken at various levels to try to understand the underlying causes of trail conflicts. In 1994 the Federal Highway Administration and the National Recreational Trails Advisory Committee sought to summarize this information and “establish a baseline of the current state of knowledge and practice and to serve as a guide for trail managers and researchers.” Their resulting report, *Conflict on Multiple-Use Trails*, offers a useful summary of possible management strategies that adhere to the “minimum tool rule,” which advocates using the least intrusive measures possible. Some of their suggestions include:

- Build trails wide enough to accommodate expected levels of use
- Provide adequate trail mileage and a variety of trail opportunities
- Provide appropriate signage and/or educational material
- Design in adequate sight distances and provide pullout areas
- Paint a yellow centerstripe and two white sidestripes on all multi-purpose trails within the City of Albuquerque Right of Way.
- Have an effective maintenance program appropriate to trail type and use.

### *Trail Difficulty Rating System*

In most instances, individuals intentionally choose a specific environmental setting when exploring the outdoors. These choices are made with distinct expectations for recreational experiences, especially with regard to the level of accessibility of a given area or facility. Because of the close relationship between the expectation and the resultant outdoor experience, successful design and management strategies should include an understanding of this cause and effect. A key to this success lies in the provision of adequate information to enable trail users to make informed decisions about a given facility.

Trail users can more easily gauge the level of effort required for a given segment of trail through the implementation of a difficulty rating system. Although no national standard format has yet been established, five key attributes have emerged for assessing the navigability of a trail facility. Referred to as the Universal Trail Assessment Process (UTAP), this system quantifies each of the following elements:

- Grade/Running Slope/Inclination (average and maximum)
- Cross Slope (average and maximum)
- Trail Width (average and minimum)
- Surface Type/Condition (firmness)
- Obstacles (type and magnitude)

Both PLAE and RAAC recommend the additional measure of summarizing the above information into a rating hierarchy similar to ski run designations – Easy, Moderate, Difficult, and Most Difficult, with accompanying “Universal Design” symbols which graphically reinforce the text designation (discussed further under “Signage” later in this report). However, it should be emphasized that without the UTAP attributes, the simple designation of “Easy” or “Moderate” becomes very subjective and may not provide adequate information to some trail users to assess their ability to negotiate a particular facility.

Of course, other factors also influence ease of use, including overall length of a given trail facility, as well as the relative distances between specific facilities, use areas, and access points. Awareness of those factors is key to determining a trail user’s ability to complete a trail segment, given their own abilities or the amount of time available. And while more difficult to quantify in terms of the above system, these factors can be conveyed via trail maps and/or mileage signs.



### ***Local Applicability (7.C.1.f)***

Trail design and construction have increased dramatically in Albuquerque since 1991 and the passage of the first federal Intermodal Surface Transportation Enhancement Act (ISTEA), which set aside unprecedented levels of funding for alternative transportation facilities, including trails. And, given the passage of its successor bills, TEA-21 and the current SAFETEA-LU (2005-2009), this trend is not likely to end soon. In short, trail planners are not waiting for a uniform federal standard for trail development. However, in the absence of any comprehensive local standards, there is a great deal of variability in the configuration of those facilities. Until the Access Board issues its “final rule” and codifies it as law, an interim standard is needed to guide trail development in the greater Albuquerque area.

Since the underlying goal is to make Albuquerque’s trails accessible to as many people as possible, regardless of ability, the trail community and the larger transportation system as a whole would best be served by striving for the highest level of accessibility that can reasonably be attained within the realms of the underlying natural landscape and physical geography. Therefore, to the extent practicable, paved trails within the City’s jurisdiction should be in substantial compliance with the current PROWAG as stated in the sections above. At such time as new federal regulations for shared-use paths are ruled and enacted, the ADAAG and PROWAG standards should still take precedence. Any trails within Federally owned and managed lands are subject to the Access board’s ruling for outdoor developed areas.

## **2. General Trail Information**

While not intending to stifle creativity or variation among projects, this document is intended to provide a basic set of design guidelines which sets forth minimum acceptable parameters for various types of trail facilities constructed within the greater Albuquerque area. The guidelines are organized into a number of categories, each of which may have up to three levels of information: **Design Standards**, which represent minimum required design criteria; **Design Considerations & Guidelines** provide background information and issues that may influence facility design; and **Design Guidance** offers suggested criteria or other information which may guide the design process.

The AASHTO Guide for the Development of Bicycle Facilities (2012 edition) has an extensive section of design guidelines for Shared Use Paths, covering the following categories:

- Separation between Shared Use Paths and Roadways

- Width and Clearance
- Design Speed
- Horizontal Alignment
- Grade
- Sight Distance
- Path-Roadway Intersections
- Signing and Marking
- Other issues, such as Lighting; Restriction of Motor Vehicles; Railroad Crossings; etc.

Rather than duplicating that information here, this document will instead focus on issues and criteria specific to Albuquerque’s multi-use trail system. The remainder of the material from the AASHTO Guide is incorporated herein by reference. In the event of a conflict with this or future versions of the AASHTO Guide, the more stringent criteria will apply.

The Federal Highway Administration’s Manual on Uniform Traffic Control Devices (MUTCD), Part 9: Traffic Control for Bicycles, is the accepted reference for most matters relating to signage, signalization, and striping of bicycle trails. The MUTCD offers three levels of information: Standards, which should be followed; Guidance, which is recommended, but not required; and Options, which are permitted, and may or may not be followed, at the discretion of the local authority. The guidelines presented in the MUTCD should be followed in the design of Albuquerque’s multi-use trails.

Shared-use paths, multi-use trails, or simply “trails,” provide a desirable facility for cyclists, pedestrians, equestrians, and other trail users. They allow for travel and recreational use that is separated from traffic. Multi-use trails should generally provide new travel opportunities while accommodating all types of trail users.

The Albuquerque Development Process Manual defines a shared-use path/trail as, “A shared use path is a bikeway physically separated from motorized vehicle traffic by an open space or barrier and constructed within the street right-of-way or within an independent right-of-way including shared-use rights-of-way or utility or drainage easements.” It is recommended to change this definition to “a shared-use path designed primarily for use by cyclists, pedestrians (including people with disabilities), for transportation and recreation purposes. Shared-use paths are physically separated from motor



*Shared-use paths (also referred to as “trails” and “multi-use paths”) are often viewed as recreational facilities, but they are also important corridors for utilitarian trips.*

vehicle traffic by an open space or barrier and are either within the public street right-of-way or within an independent (private) right-of-way.”

### ***Trail Types (7.C.2.a)***

Albuquerque’s multi-use trails can be grouped into two broad categories: paved and unpaved multi-use trails. **Paved trails** are intended to accommodate all types of non-motorized users that include but not limited to bicycles (and other types of cycles), in-line skates and ski trainers, all types of skateboards, strollers, wheelchairs, equestrians, and many types of pedestrians preferring a hard, all-weather surface. **Unpaved trails** typically accommodate but are not limited to (unless posted and signed) equestrians, mountain bikers, hikers, and pedestrians preferring a soft walking surface (stabilized unpaved trails may also be suitable for wheelchair users depending on their ability). In any given corridor, these two basic trail types may be categorized in one of three ways:

- Single Track, Limited Use – although this runs counter to the concept of “multiple-use,” there may be instances where only single use types are allowed or, more frequently, certain uses may be prohibited in order to minimize potential conflicts or impacts. This situation would most likely occur in specific management areas such as Wilderness areas or designated Open Space facilities, such as the Pino Trail at Elena Gallegos. [Site specific signage will define the appropriate usage of trails in Open Space. The Open Space Division is responsible for defining appropriate uses based on topography, environmental conditions, and to avoid potential user conflicts.](#)
- Single Track, Multiple Use – either of the trail types (paved or unpaved) within a corridor by itself, but open to any non-motorized users. This category comprises the vast majority of Albuquerque trails.
- Multiple Track, Multiple Use -- in some cases, it may be possible and appropriate to provide parallel hard and soft-surfaced trails within the same corridor. Some separation between the two types is desirable.

### ***Trail Location (7.C.2.b)***

As noted in the AASHTO Guide, multi-use trails (“shared use paths”) should serve as an off-road transportation system which augments a community’s roadway network. “Shared-use paths should not be used to preclude on-road bicycle facilities, but rather to supplement a system of on-road bike lanes, wide outside lanes, paved shoulders, and bike routes” [AASHTO, 1999, p.33]. This is because even though off-street facilities may parallel a roadway, the presence of other, usually slower, users may make the trail a less efficient (and in fact more dangerous) route for commuters or other “serious” cyclists. Multi-use trails may be located in separate, designated corridors (purchased, donated, negotiated, or dedicated during the development process), or shared rights-of-way, utilizing corridors along arroyos, power lines, and even roadways (assuming minimal driveway and other intersection crossings).

All trails built within the City of Albuquerque right-of-way should be built to the guidelines proposed in this design manual whether it is a private developer building out a section of road or an entire



subdivision. If a developer constructs a trail and it is intended to be maintained by a Homeowner’s Association, Neighborhood Association, or any means other than a public governmental agency such as the City of Albuquerque, the trail shall be built to the standards of this design manual in consultation with the Parks and Recreation Department’s Trails Planner or other City official. If a trail is to be built within a private right-of-way, it is not required to be built to City standards or specifications however, it is highly recommended. Trails built to City standards ensure longevity and high quality resulting in less maintenance costs to the entity maintaining the trail. Trails built within a private right-of-way shall never be maintained by the City of Albuquerque or other governmental or quasi-governmental entity unless there is a trail maintenance agreement or other legal agreement that is signed and accepted by the City or other agency.

The City of Albuquerque may require a “*trail maintenance agreement*” when a trail is built within the City right-of-way to ensure there is sufficient documentation of who will retain maintenance responsibility after the project is constructed. The City requires developers to help build out trail sections when they go through the development process when the trail is a proposed link on the Bikeways and Trails Facility Plan map. All trails within the public right-of-way are open to use by the public. Trails built within an independent or private right-of-way do not have to be open to the public but can be.

*Design Considerations & Guidelines*

The maps that are associated with the Bikeways and Trails Facility Plan show locations of many proposed facilities as well as existing facilities. The updated map is based on the Mid-Region Council of Governments (MRCOG) Long Range Bikeway System map, as well as many Sector and Facility Plans prepared by or for the City of Albuquerque. Specific locations should be coordinated with the City’s Trails Planner when developments are going through the design, planning, and construction process.

**3. Trail Design Criteria**

***Trail Cross Section for typical paved multi-use trail (7.C.3.a)***

*Design Standards*



**Width (same as the DPM standards)**

- 10 feet is the minimum allowed for a two-way shared-use path (trails less than 10 feet wide need an exception by the City and may need a separate legal “trail maintenance agreement”).

- 12 feet or greater is recommended for high-use areas and regional corridors, or in heavy use situations with high concentrations of multiple users, such as joggers, bicyclists, skaters, equestrians, and pedestrians.

#### **Lateral Clearance**

- A 2 foot or greater compacted shoulder on both sides.
- 3' or more from walls, fences, posts, signs, and other structures.

#### **Overhead Clearance**

- Clearance to overhead obstructions should be a minimum of 10 feet.

#### **Design Speed**

- The maximum design speed for bike paths is 18-20 mph. Speed bumps or other surface irregularities should never be used to slow bicycles.

#### **Grade**

- The recommended running grade is 5% or less. Steeper grades can be tolerated for shorter distances. See the table regarding grades. The cross slope shall be no greater than 2%. It is recommended cross slope is designed at 1.5%.

#### *Design Considerations & Guidelines*

Trails should be constructed according to this design manual. Further guidance can be found in the books and publications listed in the beginning of the manual. Constructing trails may have limitations in regards to PROWAG or any ADA document issued in the future for. Prohibitive impacts include harm to significant cultural or natural resources, a significant change in the intended purpose of the trail, requirements of construction methods that are against federal, state or local regulations or presence of terrain characteristics that prevent compliance.

#### **Surfacing (7.C.3.b)**

~~Although multi-use trails today are not required to meet any ADA guidelines the following is a smart practice to follow:~~ According to the ADA, an accessible surface must be “stable, firm, and slip-resistant” [28 CFR Part 36, Appendix A, Section 4.5.1; 1994, p. 513]. Trail or path surfaces which meet these criteria can accommodate bicyclists, in-line skaters, individuals using wheelchairs, and other trail users who need or prefer the security of a firm surface. Any pavement design should be prepared or approved by a geotechnical engineer, based on site-specific soil conditions. Nonetheless, some general design parameters apply specifically to trail construction, as outlined below.

#### **Concrete**

In general, concrete trail surfacing should follow The City’s Standard Specifications for sidewalk construction. The major difference between a concrete trail and a sidewalk is that a sidewalk is typically not wider than 6 feet. The minimum trail width is 10 feet and 8 feet with a written exception or legal

maintenance agreement with the City. Also, trails have separation between back of curb and sidewalks do not. Thickness typically should typically be four inches (4") minimum, but should be thickened to at least six inches where frequent vehicular traffic is expected (such as at curb access ramps and maintenance vehicle crossings). Addition of color may enhance the visual character of a concrete trail surface, but texturing should be kept to a minimum. Control joints should be saw cut, rather than tooled, in order to maintain a smoother, more even rolling surface.

## **Asphalt**

Asphalt is much less expensive to install than concrete and is used more often than concrete for trail applications. Asphalt is aggregate mixed with oil. It is actually meant to be driven over as the movement of a vehicle over the asphalt literally "kneads" the asphalt keeping it smooth. Therefore, it is recommended and shall be required to use a smaller aggregate for trail applications due to the lack of vehicles "kneading" the asphalt. Parks and Recreation requires "Type C" asphalt which has been typically used since 2010. In lieu of Type C, a super pave IV (SP IV) can also be used however "Type C" is recommended for paved trails. The aggregate is small which helps to keep the trail surface smooth for cyclists and pedestrians. Another concern with asphalt trail surfaces in New Mexico is oxidation (loss of asphalt binder) due to sun exposure, and cracking over time. Both of these problems can be minimized to a small extent through modification of the pavement mix to increase the amount of asphalt binder in relation to the aggregate, as compared to a standard roadway mix. Care should be taken, though, not to increase the binder content to the point that the surface becomes difficult to finish.

Surface thickness also affects the durability of asphalt. Since the design of asphalt surfacing is generally based upon vehicular loads, two inches is usually considered more than adequate to support bicycle and foot traffic. However, since bicycles are not heavy enough to provide the "kneading action" of automobile traffic (which helps hold asphalt roadways together), surface integrity relies solely on the tensile strength of the asphalt binder. Current thinking generally holds that increasing the thickness of the asphalt surface will in turn increase durability and help reduce cracking. Therefore, although the typical trail section in the City's Standard Specifications for Public Works Construction shows 2" of asphalt over 8" of compacted subgrade, the recommended design thickness for trail surfacing when maintenance vehicles will be utilizing the trail consists of 3" of asphalt over 12" of compacted subgrade. In areas with soft (sandy or high clay content) subgrade material, the addition of 4" of engineered base course is recommended. Final determination of subgrade and base course treatment should be made by a qualified civil or geotechnical engineer and it is recommended that 12" of subgrade preparation at 95% compaction rather than 8" of subgrade be used on all new and rehabilitated paved trails. Unless otherwise determined by a civil or geotechnical engineer, aggregate base course should have an "R-Value"  $\geq 76$  and subgrade should have an "R-Value"  $\geq 50$ .



Figure 1: Typical Paved Multi-Use Trail Cross Section

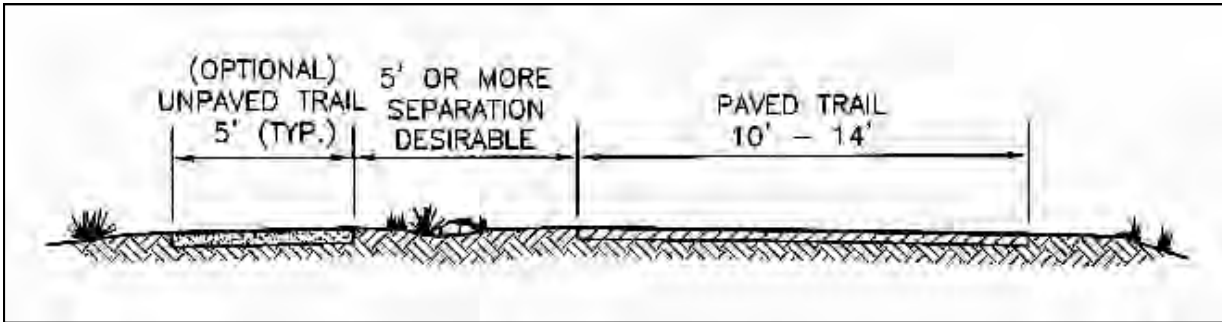
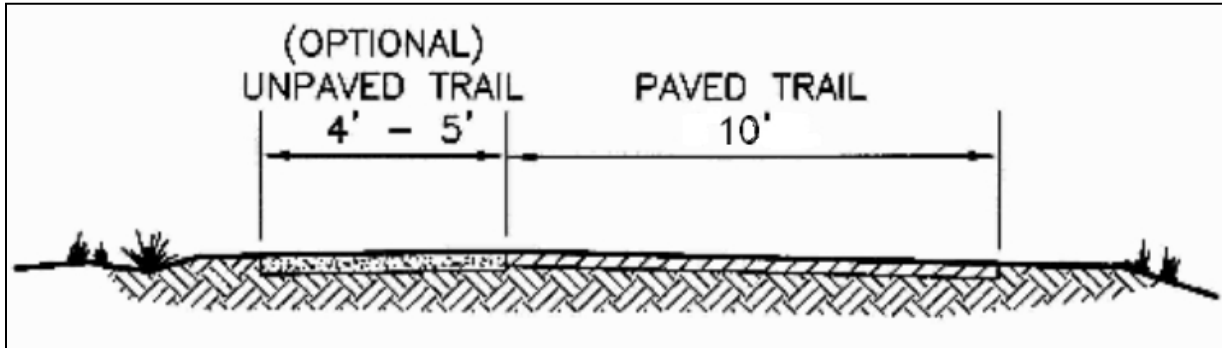


Figure 2: Typical Paved Multi-Use Trail Cross Section (no separation)

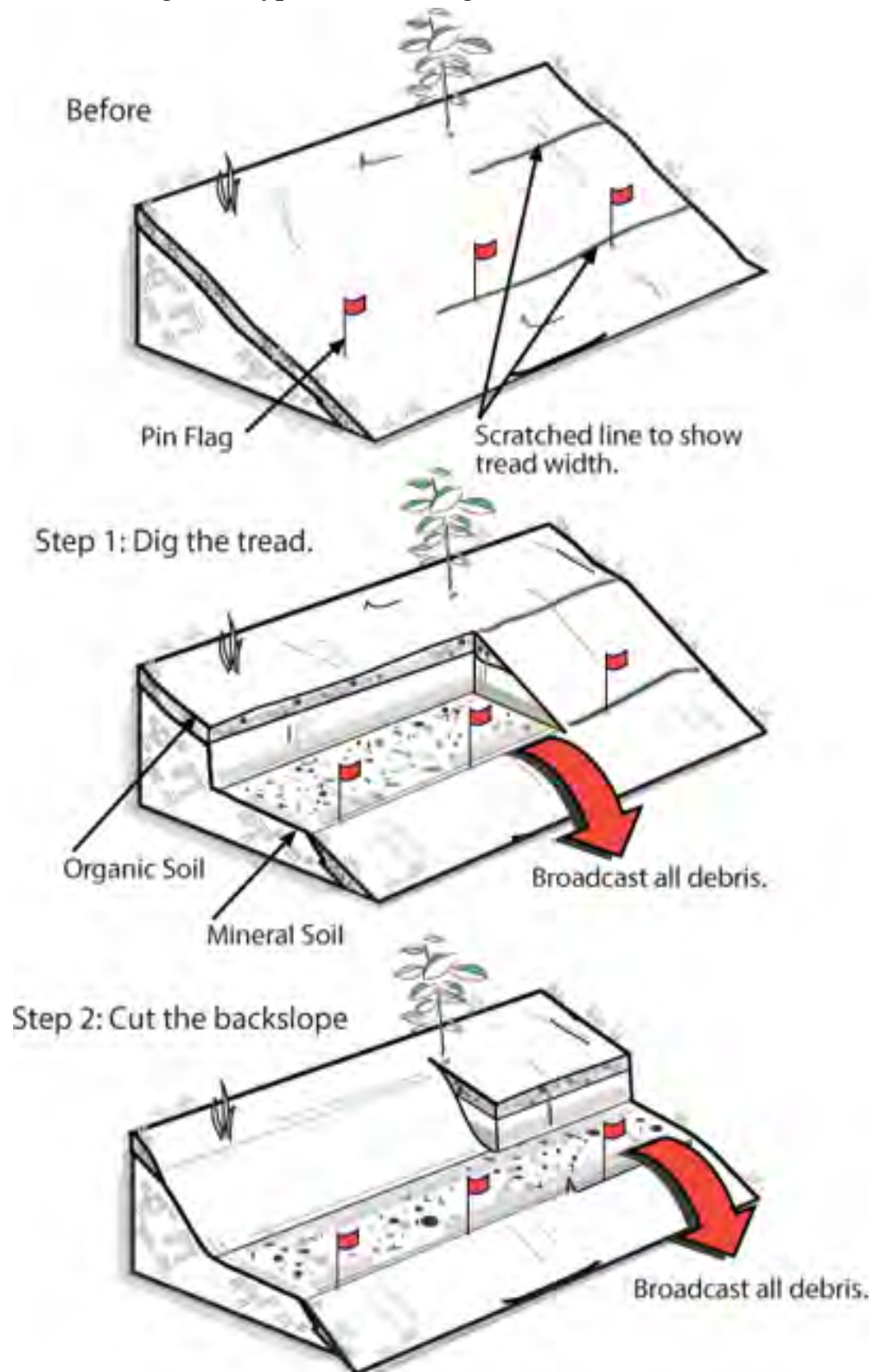


## Unpaved Trails

Unpaved (non-stabilized) trails within the urban/rural area are sometimes provided as an alternative to parallel paved facilities, primarily for use by equestrians or joggers. However, Major Public Open Space has over a hundreds of miles of unpaved natural surface multi-use trails throughout all quadrants of the City and beyond in Bernalillo and Sandoval County. In many cases, the existing native soil is suitable for surfacing such trails, especially in Major Public Open Space (unless a stabilized crusher fine ADA type trail is desired). These could include 3/8" or smaller angular gravel, crusher fines, decomposed granite, or other suitable soils (e.g. sandy loams) which remain firm underfoot in both wet and dry conditions. A 3"- 4" layer of these imported materials should be adequate in most instances if subgrade soils provide adequate support (greater depth may be required over loose sand or silt). Unpaved trails should be separated from paved trails within the same corridor as far as possible, given right-of-way constraints.

Unpaved trails are typically classified as "singletrack" trails. These are primarily found in Major Public Open Space areas. However, The City Open Space Division also maintains and manages a few paved trails as well. Actually, when looking at the trail system as a network City Major Public Open Space maintains a large majority of trails within the regional Albuquerque area and beyond. Most of these "MPOS" trails differ in design and construction from the paved trail network with exception of the MPOS paved trails but they are just as important and need to be addressed in this design manual as they are considered part of the overall trail network. Some basic MPOS trail designs are listed below for MPOS trails. For more detailed information on MPOS trail standards, trailhead design, signage, etc. please refer to the draft MPOS trail standards. These can found by contacting the Open Space Division directly. Major Public Open Space trails' typical cross sections differ from the paved trail cross sections as seen in figures 1 and 2 above. Each MPOS property is different and trails are designed to accommodate specific environmental terrains and conditions. However, the natural surface trails designed and constructed by the Open Space Division typically follow the International Mountain Bicycling Association publication entitled "Trail Solutions; IMBA's Guide to Building Sweet Singletrack" 2004 edition. Figures 3 through 6 are typical examples used by the Open Space Division for design and construction of MPOS trails. Unless noted as either Major Public Open Space, MPOS, or Open Space in this design manual, all other material is referring to trails that are not MPOS with the exceptions of any paved and maintained by MPOS trail sections such as the northern section of the Paseo del Bosque Trail.

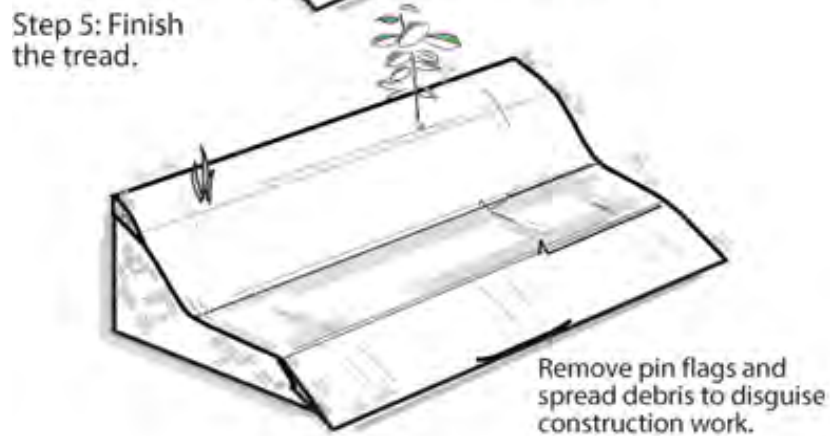
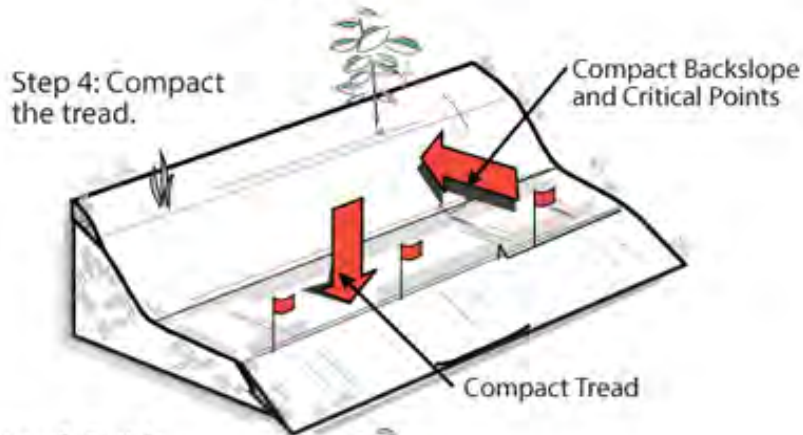
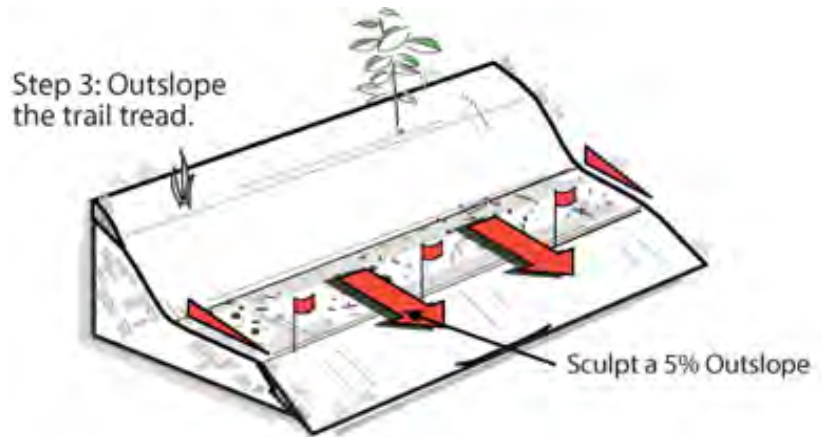
Figure 3: Typical MPOS Singletrack Full Bench Trail



Source: *Trail Solutions: IMBA*

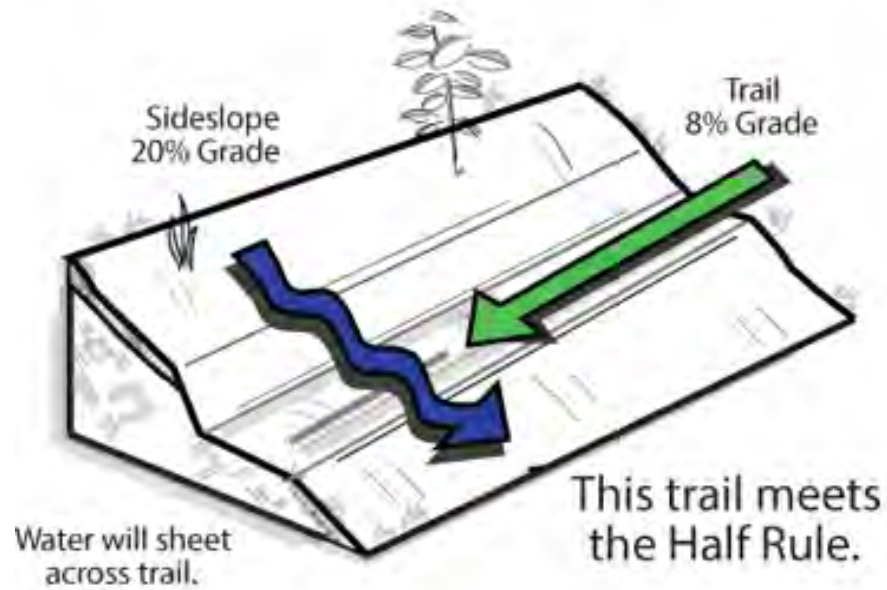


Figure 4: Typical MPOS Singletrack Full Bench Trail (cont.)



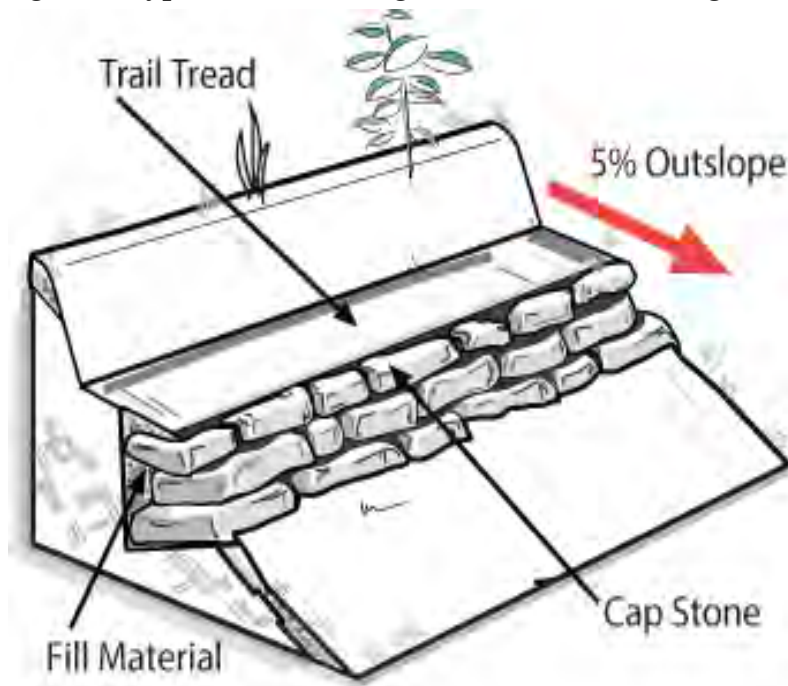
Source: *Trail Solutions: IMBA*

Figure 5: Sustainable Trail Design using the Half Rule  
Half Rule



Source: *Trail Solutions: IMBA*

Figure 6: Typical MPOS Design for Natural Retaining Walls



Use only rocks and mineral soil for back fill. Don't use organic material.

*Source: Trail Solutions: IMBA*



### *Design Considerations & Guidelines*

Asphalt is the most widely used surfacing for paved trails in the Albuquerque area, due primarily to its lower cost, and ease of installation and maintenance. It also offers a smooth surface, if installed correctly, and holds up relatively well over time, since it is not subject to the degree of frost heave or other environmental degradation often encountered in harsher climates.

Concrete is also commonly used for trail surfacing, although less so in Albuquerque than other locations. The primary benefit of concrete is its longevity and smoothness, resulting in reduced maintenance requirements and associated long-term costs. However, its initial installation cost often outweighs the long-term benefit of a concrete surface; especially here in Albuquerque where geographically it is vastly sprawled out and hundreds of miles of trail are needed to adequately connect the City together. Other perceived problems with concrete include the rigidity of the surface (runners usually prefer the flexibility of asphalt) and the somewhat large spacing of the required construction and crack-control joints (esp. for skateboards). These complaints can often be overcome by providing an adjacent soft-surfaced trail for runners, and using saw-cut control joints, rather than tooled joints, in concrete that create a tighter gap.

Environmentally-friendly variations on traditional pavement are also becoming more readily accepted and available. One such variation involves the use of recycled materials (such as shredded tires, plastic, or even crushed glass) in place of a portion of the normal stone aggregate in asphalt or concrete. Another removes the “fines” (smallest components) from the mix aggregate to create a porous pavement, which enables water to pass directly through the pavement and infiltrate into the ground below, thus minimizing runoff. Other alternatives which are gaining acceptance as naturalistic, yet stable trail surfaces involve the use of organic or synthetic binders to form pavements using native soils or other decorative materials; and even the use of brick or concrete pavers. While the use of alternative surfacing may be appropriate in certain circumstances, some of these materials may have limited application for urban trails, due to potential deterioration and/or unevenness of the surface. In any case, sound engineering judgment should be used in determining suitability of materials for trail use on any given project.

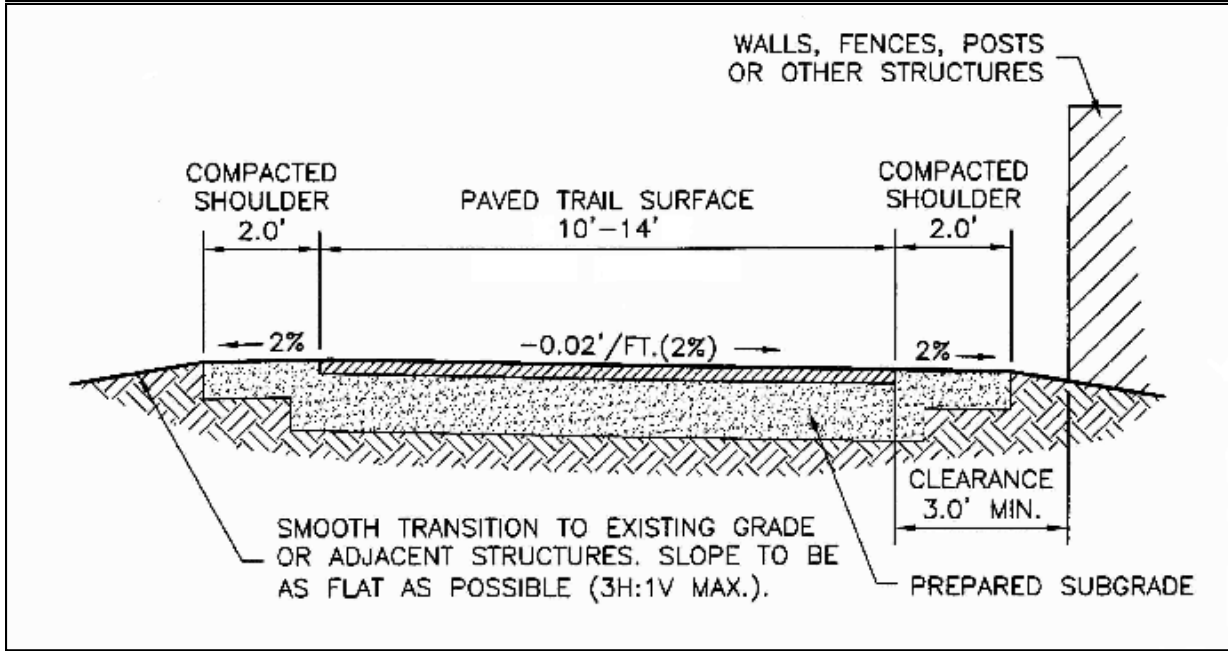
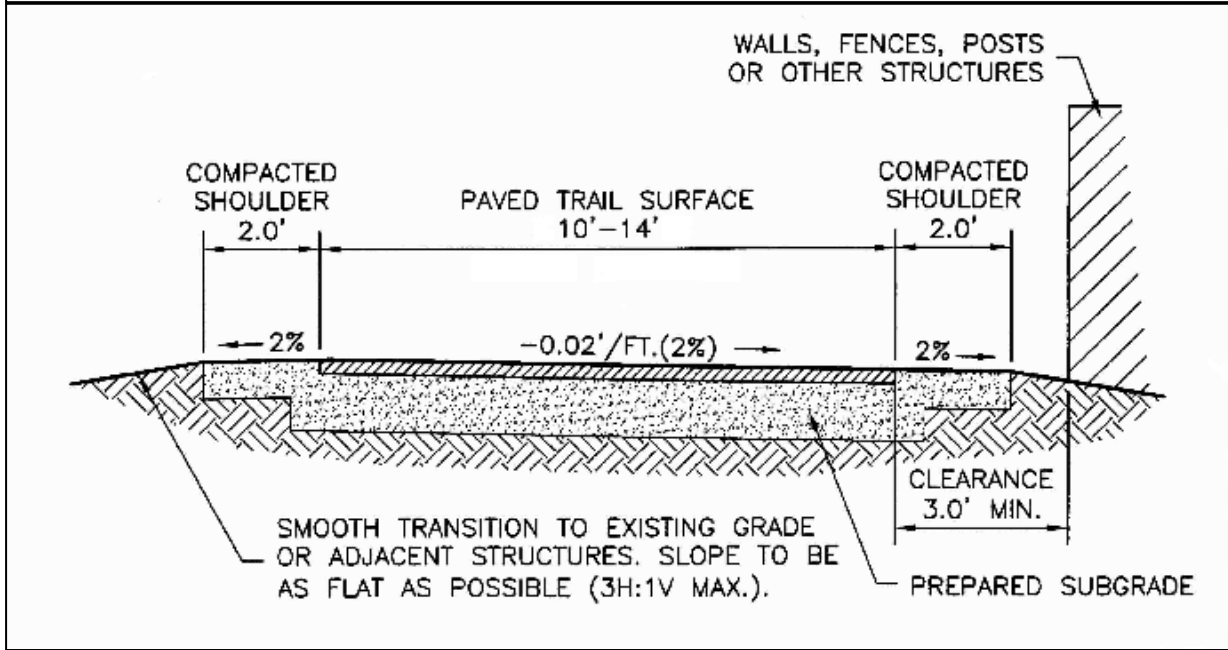
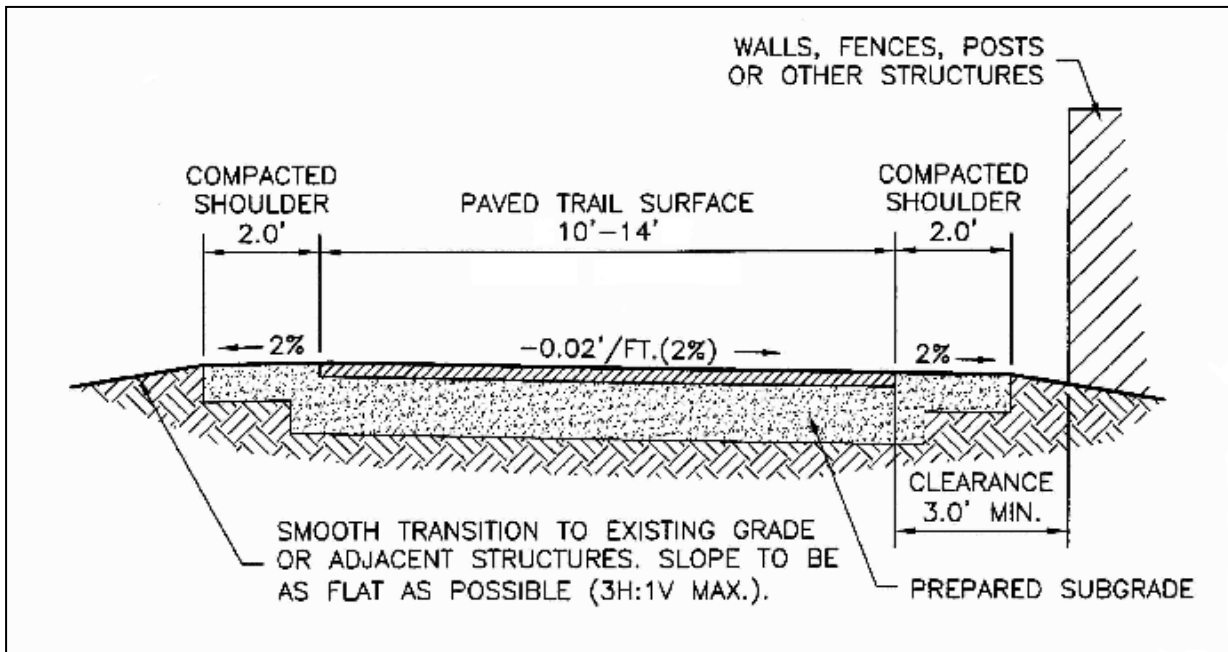
### *Trail Dimensions (7.C.3.c)*

Trails should be of sufficient width to accommodate expected numbers of users without excessive interference. Side slopes and clearances from adjacent obstacles should be designed to minimize danger to cyclists who may inadvertently stray from the paved surfacing. Shoulders should provide a stable recovery surface in those instances. Railings (addressed later) may also be used to keep trail users from leaving the paved path, and may be placed within the 2'-3' clear (recovery) zone illustrated below. Refer to the AASHTO Guide for additional information not addressed here.

### *Design Standards*

Typical paved trail dimensions and clearances are shown in Figure 7, below.

Figure 7: Paved Trail Dimensions and Clearances



Shared-use paths should be constructed according to this design manual and to the AASHTO Guide for the Development of Bicycle Facilities when and where feasible. Shared-use paths will be designed according to American with Disabilities Act (ADA) standards when a Federal ruling is adopted by the Access Board. In the meantime, trails (paths) will be constructed using the best ADA practices as adopted through the “Public Rights of Way Accessibility Guidelines” (PROWAG) when and where possible. Constructing trails may have limitations that make meeting ADA standards difficult and sometimes prohibitive. Prohibitive impacts include harm to significant cultural or natural resources, a significant change in the intended purpose of the trail, requirements of construction methods that are against federal, state or local regulations or presence of terrain characteristics that prevent compliance. Parks and Recreation is currently (started in 2013) auditing all paved trails for ADA compliance. Once the audit is completed, the report will show how many miles of trail and which trails can be utilized by people with disabilities.

### *Design Considerations & Guidelines*

Shared-use paths serve cyclists and pedestrians and provide additional width over a standard sidewalk. Facilities may be constructed adjacent to roads (sidepaths), through parks, or along linear corridors such as active or abandoned railroad lines or waterways. Regardless of the type, paths constructed next to the road should have some type of vertical (e.g., curb or barrier) or horizontal (e.g., landscaped strip) buffer separating the path area from adjacent vehicle travel lanes. However, sometimes right of way restrictions hinder the possibility for a vertical or horizontal barrier. It will be determined the engineers, designers, and planners if the benefits of having a trail outweigh the risks when the ROW is constrained.

Elements that enhance shared-use path design include:

- Providing frequent access points from the local road network. If access points are spaced too far apart, users will have to travel out of direction to enter or exit the path, which will discourage use.
- Placing directional and way finding signage to direct users to and from the path.
- Building to a standard high enough to allow heavy maintenance equipment to use the path without causing it to deteriorate.
- Limiting the number of at-grade crossings with streets or driveways.
- Terminating the path where it is easily accessible to and from the street system, preferably at a controlled intersection or at the beginning of a dead-end street. If poorly designed, the point where the path joins the street system can put pedestrians and cyclists in a position where motor vehicle drivers do not expect them.
- Identifying and addressing potential ~~safety and~~ security issues up front.
- Whenever possible, and especially where heavy use can be expected, separate bicycle and pedestrian ways should be provided to reduce conflicts.
- Providing accessible parking space(s) at trailheads and access points.



- Providing, where possible, a soft surface shoulder adjacent to paved surfaces for use by joggers and equestrians.

Trails should be of sufficient width to accommodate expected numbers of users without excessive interference. Side slopes and clearances from adjacent obstacles should be designed to minimize danger to cyclists who may inadvertently stray from the paved surfacing. Shoulders known as the “recovery zone” should provide a 2-3’ stable recovery surface in those instances. Compacted base course, subgrade, or crusher fines are recommended and gravel should not be used unless the aggregate is finer than 3/8”. Railings (addressed later) may also be used to keep trail users from leaving the paved path, and may be placed within the 2-3’ clear zone illustrated below. Refer to the AASHTO Guide for additional information not addressed here.

### ***Trail Alignment (7.C.3.d)***

Although multi-use trails are, by definition, intended for many modes of use, the design of those trails is effectively determined by only a few user groups – those with the most stringent requirements. In the case of paved trails, this presents something of a conundrum, in that the design must accommodate two sometimes-conflicting extremes. Bicycles, on the one hand, are a very efficient means of transportation, capable of fairly high speeds and long distances. Wheelchairs, on the other, are relatively inefficient and slow. While both have wheels, and therefore share some basic requirements in terms of surfacing, most other design requirements for the two are quite different. In order to accommodate wheelchairs which typically have shorter travel distances and may need frequent rest stops on as many multi-use paths as possible, shared-use paths will need to meet the requirements of the Americans with Disabilities Act (ADA) once a proposed ruling by the Access Board is adopted by the Department of Justice as an “enforceable standard”, which currently does not exist for shared-use paths. In contrast, AASHTO guidelines for bicycle design focus on higher travel speeds, and efficiency of movement. Nonetheless, the two are not mutually exclusive. Trail designers must find the common ground between the two seemingly contradictory sets of criteria, and work within those parameters. In the simplest of terms, while the overall design of a trail facility should obviously take both modes into consideration, bicycles tend to dictate horizontal alignment criteria, while wheelchair requirements drive the vertical alignment.

The information which follows is a summary of trail design criteria which should satisfy both ADA and AASHTO for use in the design of Albuquerque’s urban multi-use trails.

### ***Design Standards***

**Table 2: Maximum Recommended Running Grade Lengths**

Max. Running Grade	For Distances Up To:
5% or less	Unlimited
8.33%	200 ft. with resting intervals
10%	30 ft. with resting intervals
12.5%	10 ft. with resting intervals

\* Defined under ADA accessibility guidelines for outdoor areas

**Table 3: Minimum Recommended Curve Radii for Paved Trails**

Grade	Design Speed	Min. Centerline Radius*
less than 3%	20 mph (30 km/hr)	95 ft. (29 m)
3% - 5%	25 mph (40 km/hr)	160 ft. (49 m)
greater than 5%	30 mph (50 km/hr)	265 ft. (81 m)

\* Assumes 2% superelevation (cross slope in direction of curve)

**Table 4: Recommended Vertical Curve Radii for Paved Trails**

Grade Change (Algebraic Difference)	Minimum Length for Crest Curve	Minimum Length for Sag Curve
less than 2%	None Required	None Required
2% - 4%	10 ft. (3 m)	60 ft. (18 m)
>4% - 6%	60 ft. (18 m)	160 ft. (49 m)
>6% - 8%	100 ft. (30 m)	300 ft. (91 m)
greater than 8%	160 ft. (49 m)	500 ft. (152 m)

### *Design Considerations & Guidelines*

#### **Grade**

Trails in the urban area should be designed to provide running grades of 5% (20H:1V) or less wherever possible. If necessary, due to existing terrain or right-of-way constraints, grades up to 12.5% (8H:1V) are permissible, provided that a rest area be provided every 10 feet (77 cm) of vertical rise. See table 1 above for running grades and recommended resting intervals. Such rest areas may be integral with the trail (i.e. a landing with a maximum grade of 2.03% at least 5 feet in all directions of the landing pad), or, with approval of the City's project manager, may be offset alongside the trail, in order to provide a more even surface for bicycles and other faster-moving uses. Table 1 lists recommended maximum distances for

various trail grades under the current most stringent ADA guidelines for outdoor recreation areas. It should be noted that the natural environment terrain and grade may prohibit ADA compliance. This is allowed as long as the entire system or trail network has a certain amount of ADA accessible trails located throughout the City. In addition, the standards may be waived where compliance would cause “substantial harm to cultural, historic, religious or significant natural features or characteristics.”

### **Horizontal Curves**

Many factors, including design speed, tire friction, lean angles, sight distances, and braking capabilities, are involved in determining minimum acceptable dimensions for horizontal alignments of bicycle facilities. These are covered in detail in the AASHTO Guide [pp. 37-46]. By default, facilities which are designed to facilitate the turning movements of two-way bicycle traffic would easily accommodate the spatial requirements of wheelchairs and other slower modes of travel. However, the same is not true for vertical alignment. It is, in fact, difficult to separate horizontal and vertical alignment criteria, so the designer should carefully weigh the impact that any changes to one might have on the other. As can be seen in the tables in the Design Standards below, the grade selected for a vertical alignment affects design speed, which in turn affects the minimum turning radius.

Curves sharper than those in the table below may be necessary in circumstances of limited right-of-way or other physical constraints. If so, such curves should be identified by solid centerline striping and warning signs per the MUTCD.

### **Vertical Curves**

Vertical curves are used to make a smooth transition at changes in trail grade. This issue comes most sharply into focus in the design of ramps which meet the letter of ADA requirements, but also must serve bicycles. The typical alternating 30-foot, 12:1 (8.33%) ramp and 5- to 10-foot level landing configuration (often seen on bridge approaches and other areas of significant grade change) makes for abrupt transitions and runs contradictory to the 30 mph design speed recommended in the AASHTO Guide for such grades. Adding at least a short vertical curve at each change in grade will provide a much smoother travel surface, and ~~increase user safety~~ lessen the potential for accidents by minimizing the chance of bicycles (and even some other modes of wheeled use) becoming airborne.

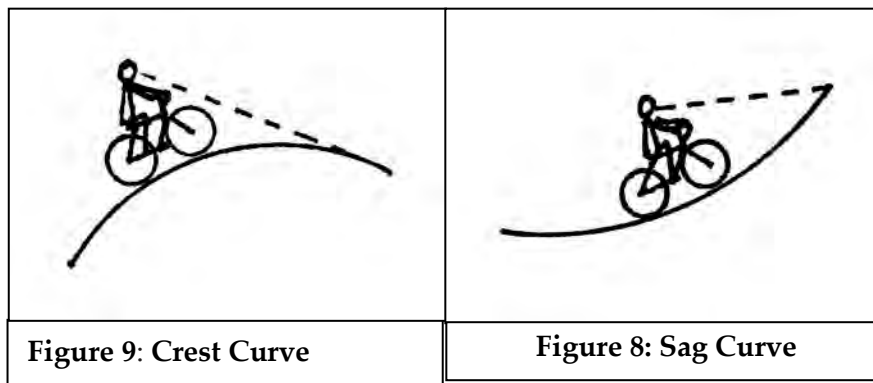
The most recent AASHTO Guide provides tables listing minimum lengths of Crest Vertical Curves (e.g. over the top of a hill) [pp. 43, 44], but no longer provides that information for sag curves (e.g. at the bottom of a valley), stating only that the minimum length of a vertical curve should be one meter (3 ft.). The previous (1991) AASHTO publication did not differentiate between the two types, offering a single graph [p. 29] that presented minimum lengths for any vertical curve based upon grade differential and design speed. The current differentiation is due to the fact that crest and sag curves are governed by different criteria. While crest curves can occur either at the top of a hill or in the middle of a slope, in both cases approach speeds are generally slower than exit speeds. Nonetheless, stopping sight distance



(the distance that the trail surface is visible ahead) is usually the primary concern, since the slope is breaking away from the user. Sag curves represent the opposite conditions, and usually see the highest speeds on the approach to the grade change. Visibility is rarely an issue; instead, user comfort and ease of negotiation (due to resultant “G” forces) are the main criteria. So while the AASHTO guide has relaxed its recommendations for vertical sag curves, the resultant abrupt change in some instances might make for uncomfortable riding conditions for cyclists. In lieu of the 3’ minimum requirement, Table 3 below suggests vertical curves which will make for a more pleasant trail experience.

In general, vertical curve grade transitions should be designed to provide as gentle a transition as possible, given the physical constraints of a site. The table below provides suggested lengths of vertical curves for various conditions, based on 2% increments in grade change. These numbers are generalized and should provide acceptable results in most cases; however, if more detailed information is required, please refer to the current AASHTO Guide.

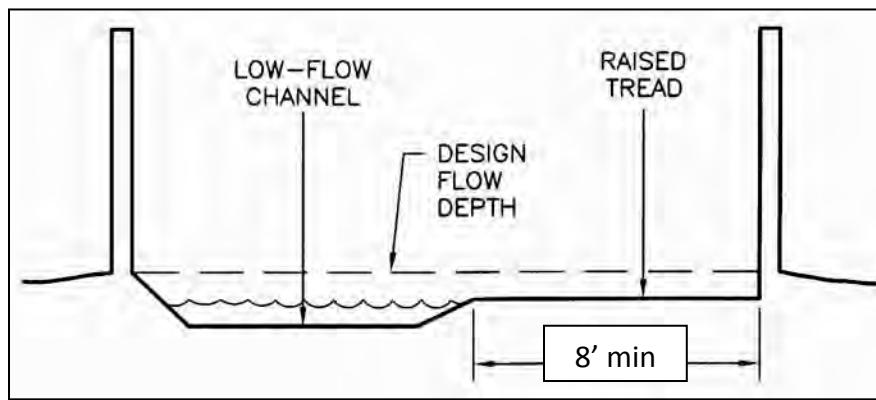
As with horizontal curves described above, there will undoubtedly be instances when such lengths cannot be achieved in designing vertical curves. In the case of the accessible ramp design described above, provision of even a short vertical curve at each grade transition will permit easier negotiation by bicycles.



## 4. Drainage

Since many trails follow drainage features (e.g. arroyos or ditches), they often must address not only drainage issues related to the trails themselves, but also accommodate runoff originating elsewhere. In fact, “neighborhood access” to a trail is often provided via wide rundowns which carry storm water from adjacent streets into shared arroyo/trail corridors. This is not a desirable configuration. Both the water itself, and the silt and debris which invariably accompany it, make for potentially hazardous trail conditions. Instead, parallel facilities should be provided which keep the trail access separate from the drainage way, or the trail access tread can be elevated six to eight inches above a low-flow channel within the rundown (Figure 10). Likewise, when trails cross drainage rundowns along the edge of a channel, the drainage flow should be routed under the trail, rather than across it.

**Figure 10: Neighborhood Trail Access via Shared Drainage Rundown**



### *Design Considerations & Guidelines*

In general, drainage design for trails does not differ greatly from drainage design for roadways. Nonetheless, a few key principles should be highlighted here:

- Trail surfaces should have a 1% to 2% cross slope, and uniform surface planarity (no depressions or “bird baths”) in order to prevent water ponding on the trail;
- Interception ditches should be provided on the uphill side of trails which traverse slopes or hillsides, to prevent runoff from washing sediment onto the trail;
- Drainage grates or other structures should be sized and/or located so as not to interfere with trail traffic (narrow bicycle tires in particular).
- Culverts should be sized adequately to pass expected flows and allow for easy maintenance, including removal of debris. Minimum culvert size should be 12” diameter; 18” diameter is preferred for maintenance purposes.



*Albuquerque has significant opportunities to develop trails along drainage ditches.*

## Equestrian Facilities (7.C.4.a)

### Design Standards

#### Width

- 5-6 feet in low (rural) development
- 8-12 feet in moderate to high development

#### Lateral Clearance

- A 3 foot or greater shoulder on both sides.

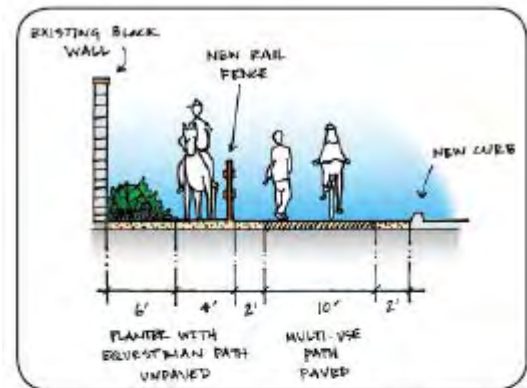
#### Overhead Clearance

- Clearance to overhead obstructions should be 10 foot minimum, with 12 feet recommended.

### Design Considerations & Guidelines

With a multi-use trail system, planners and designers should always work to incorporate facilities that will accommodate all trail users whenever possible and feasible. Equestrians often are not thought about when designing in more urban trail areas. With an ever growing and interconnected trail system that extends from rural to urban, equestrian design should always be incorporated. Specifically, a bridge or tunnel should be expected to be used by equestrians and additional criteria should be taken into consideration:

- Overhead clearance is particularly important to accommodate both horse and rider. Ten-foot clearance is a minimum (twelve feet is preferred) without requiring the rider to dismount or duck.
- Horses may be frightened by the sound and motion of traffic beneath them, which could, in turn, result in injury to the rider. Therefore, equestrians tend to prefer underpasses to bridges. (However, adequate sight distances are critical. Poorly designed underpasses can also be dangerous, if, for example, a fast-moving bicycle suddenly appears within the confines of a narrow tunnel.) If a bridge is the only alternative for an equestrian crossing, solid side walls or other screening should be provided for at least three feet up from the bridge deck to minimize visibility of traffic below.
- Trail etiquette signs are triangular and look like yield signs and should be placed throughout the trail system/network. See [figure X](#) which is the current sign being used by the Parks and Recreation



Recommended design for a multi-use path that accommodates equestrians.



Example multi-use equestrian trail.



Department in the greater Albuquerque area. These signs help to educate trail users understand who has the right of way when approaching and passing each other. The sign is typically made to be 24x24 inches in size.

Walkers, hikers and cyclists often share trail corridors with equestrians. Pedestrians and riders are often compatible on the same tread as they both accept unpaved surfaces and move at relatively slow speeds. However, fast moving and quiet cyclists approaching a horse from behind are a valid concern for riders. In areas where conflicts seem likely, efforts are made to physically separate the different user groups.

For equestrian routes, trail tread or surface should be relatively stable. The trail surface should be solid, obstacle-free and should stay in place. Appropriate trail surfaces include: compacted native soil, crusher fines and decomposed granite. Hard surfaces, such as asphalt and concrete are not amenable to equestrians.

Trails that are comfortable for equestrians are ones that accommodate most trail users. While horses can easily negotiate grades up to 20 percent for short distances (up to 200 feet), steeper running grades result in faster water run-off and erosion problems. Following contours helps reduce erosion problems, minimize maintenance needs and increase comfort levels. A 2 percent cross slope or crowned tread and periodic grade reversals along running slopes will minimize standing surface water and will resolve most drainage issues on a multi-use path. An exception is to cut sections where uphill water must be collected in a ditch and directed to a catch basin, where the water can be directed under the trail in a drainage pipe of suitable dimensions. Additionally, on running grades steeper than 5 percent, add 6-12 inches of extra tread width as a safety margin to enhance user comfort where possible.

- USDA/FHWA Equestrian Design Guidebook for Trails, Trailheads, and Campgrounds.

#### ***Shared Use of Drainage Facilities (7.C.4.b)***

In recent years, the shared use of drainage channels for underpasses beneath major roadways has become more commonplace in the Albuquerque area. Trails are most often accommodated through such crossing by creating a notch in the side of the channel, with ramps leading in and out of the crossing. Less frequently, suspended platforms have been mounted on the side of the channel where adequate flow capacity exists. The notched configuration, while significantly more expensive, is generally preferred by drainage authorities because it does not impede the flow of water in the channel, and, in fact, increases the channel cross section (and carrying capacity) at the bridge crossing. Figures 11 - 13 show possible configurations of such a crossing, based upon the depth and capacity of the channel at the crossing.

Figure 11: Trail Underpass Notched Into Side of Channel

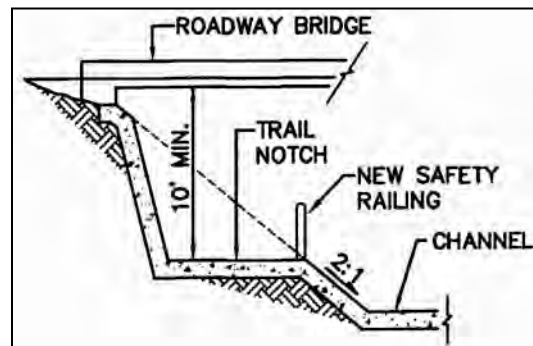


Figure 12: Depressed Underpass for Low Bridge Clearance Condition

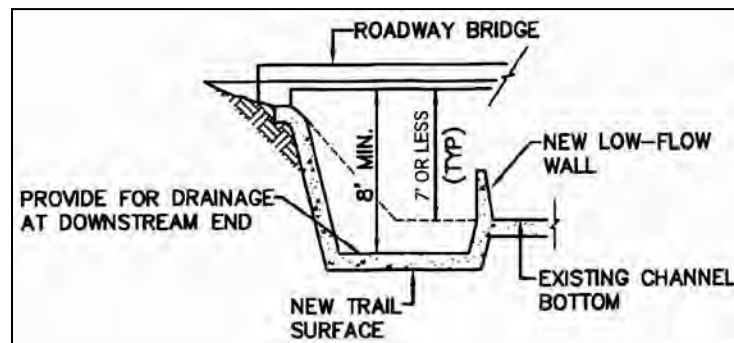
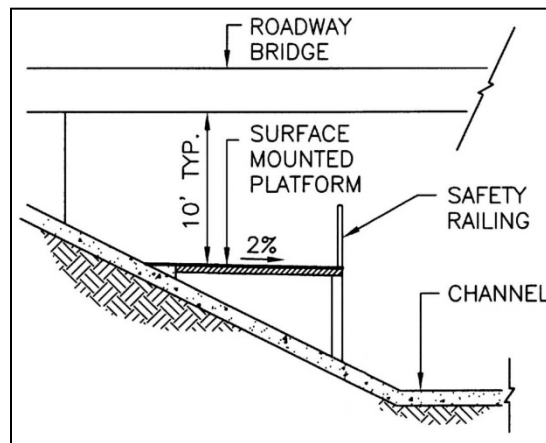


Figure 13: Trail Underpass Attached to Channel Surface



One of the primary concerns about placing trail crossings within major drainage channels lies in the fact that users are essentially directed into a potentially dangerous situation, where storm runoff may inundate the trail. Although the probability of such an occurrence would be quite low at any given time, it is nonetheless a valid concern. The safety-potential hazard of such a crossing can be greatly ~~increased~~ decreased through the following actions:

- Provide safety-hand railings at the edge of the trail surface, in accordance with the Access Control section below.

- Post signs at either end of the crossing warning users not to enter the underpass if water is present or flowing across the trail surface.
- Provide alternate, at-grade crossing opportunities for times when the trail crossing may be flooded.
- Design notch configurations to keep the trail surface above the nominal “10-year design flow” depth, and such that inundation of the trail would be minimal for a “100-year” flood event.

If trail users heed the second guideline above, the last one would not be much of an issue. However, the fact remains that common sense does not always prevail, or that a trail user might unintentionally end up in such a situation (e.g. brake failure or other unforeseen mishap). While no national standard exists for acceptable flow depth across a trail, depths of two to three feet greater than one-foot should be viewed as the maximum allowable condition. Any deeper, and stormwater flows begin to obscure the railing at the trail edge, limiting or eliminating the safety benefit it should provide.

***Shared Use of Irrigation Ditches (7.C.4.c)***

~~Any trail proposal for an MRGCD owned or managed facility has to be reviewed and approved by us for adequate right of way, current management and maintenance of that facility, landownership and ability for another local entity to manage and maintain the trail through a license agreement. The size of the facility and available right of way are strong determinants in the feasibility of a multi-use trail that can be separated from the MRGCD's required maintenance access. Other than at road crossings, rails and fences are generally not installed along ditch banks as they prevent or impede our access and maintenance.~~

~~Equestrians use unimproved maintenance roads and trails on our facilities and generally keep distance from bicycles and other fast moving users. Our ditches and drains are used by and very important to equestrians in the valley and we try to provide or maintain access wherever feasible/desirable.~~

~~Wherever possible, multi-use trails should meet ADA standards for design and access. It's helpful to make them higher in elevation than the maintenance road for drainage and so less material migrates onto the trail. The opinion about bollards is that they can cause some hazards on a trail but we are increasingly using them rather than the horse log step overs to provide better access for those who have more mobility issues, bicycles, strollers, etc. while excluding vehicles and four and three wheelers (ATVs).~~

~~The trail corridors proposed for the Corrales Main Canal and Alameda Drain will need more study for feasibility. Some funding has been allocated for the Alameda Drain from Matthew Ave. north to Alameda Blvd. and reconnaissance and coordination efforts have commenced.~~

~~It would be good for the MRGCD, City and County to develop maintenance and management standards and signage/information more specific to trails on MRGCD facilities as the concerns, management, opportunities and purposes are unique.~~



### **Shared Use of Utility Corridors**

PNM transmission rights of way or easements are identified as the location for several proposed bike routes or trails. As the easement holder, PNM has the legal right to use and maintain the easement including ensuring vehicular access to the lines, maintaining adequate clearances, and other safety measures. If the bike lanes and/or trails become guest uses at these locations, an encroachment agreement will be necessary. The City also needs to directly contact the underlying property owner. In addition, it will be the City of Albuquerque's responsibility to ensure that PNM's uses of the easement are not affected or interfered with in any way by the inclusion of the bike lane or trail.

Four proposed bike lane and/or trail locations are identified within PNM's 115kV transmission rights of way and easements. The four locations are:

- Along the PNM CE 115kV transmission line from Irving Blvd. NW heading north toward McMahon Blvd. NW
- Along the PNM BW 115kV transmission line north of Interstate 40 east of Atrisco Vista Blvd NW
- Along the PNM SE 115kV transmission line/ID 46kV transmission line corridor in Tijeras Arroyo
- Along the PNM RE/ER 115kV transmission line corridor on San Antonio Drive NE just west of Tramway Blvd NE

Based on PNM's experience constructing and maintaining facilities at these locations, the terrain is difficult and is not conducive for bike trails. Coordination with PNM will be necessary as trails are developed at any of these four locations.

PNM does not support the development of trails within PNM existing 345kV transmission line rights of way or easements. The higher voltage lines can potentially result in electrical nuisance shocks. Nuisance shocks may occur when a person touches an ungrounded metal object, in this case, such as bicycle handlebars. A nuisance shock does not harm the recipient but can be startling. PNM will not grant an encroachment easement in 345kV transmission corridors.

## Trail Accessibility (7.C.4.d)

### Design Standards

- 3 feet minimum clear width, where less than 5 feet, passing space should be provided at least every 100 feet.
- Cross slope should not exceed 2 percent where and when possible.
- Curb ramps shall be provided at roadway crossings and curbs. Tactile warning strips and auditory crossing signals are recommended along with any other mandated ADA street crossing criteria.

Running slopes typically should not exceed 5%. However, certain conditions may require the use of steeper slopes for grade separated crossings (refer to table 1 for recommended maximum running slopes).

- The trail surface shall be firm and stable. The Forest Service Accessibility Guidelines defines a firm surface as a trail surface that is not noticeably distorted or compressed by the passage of a device that simulates a person who uses a wheelchair. Where rights-of-way are available, paths can be made more accessible by creating side paths that meander away from a roadway that exceeds a 5% slope.

### Design Considerations & Guidelines

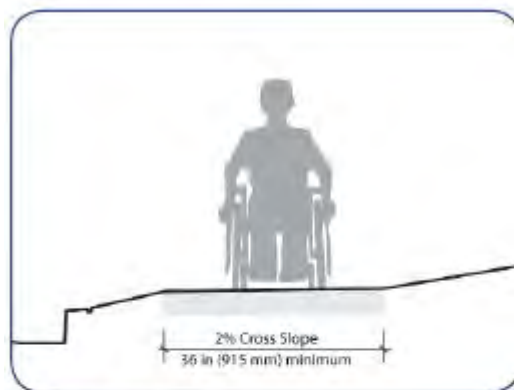
- General guidelines have been created in response to the ADA for accessible trails.
- FHWA. (2001). Designing Sidewalks and Trails for Access, Chapter 14: Shared Use Path Design, Section 14.5.1: Grade.

[www.fhwa.dot.gov/environment/sidewalk2/sidewalks2\\_12.htm#tra2](http://www.fhwa.dot.gov/environment/sidewalk2/sidewalks2_12.htm#tra2)

- Regulatory Negotiation Committee on Accessibility Guidelines for Outdoor Developed Areas Final Report, (1999). [www.access-board.gov/outdoor/outdoor-rec-rpt.htm](http://www.access-board.gov/outdoor/outdoor-rec-rpt.htm)

### Access Control (7.C.4.e) – Ensure consistency with DMD Bollard Study

Access control devices are intended to ~~assure~~ minimize the potential for trail user safety conflicts by restricting vehicular access to trails or serving as barriers from dangerous conditions. Access control measures can include, but are not limited to, railings, fences, gates, and bollards or guard posts. Landscaping and/or natural features can also be used



ADA clearance requirement.



Shared-use paths surfacing materials affects which types of users can benefit from the facility.

effectively for access control in some settings. Each type of access control has its place, as indicated in the Design Guidance below.

### *Design Standards*

#### **Bollards/Guide Posts**

Bollards should only be used or installed in areas where it is likely a vehicle will mistake the trail for a possible vehicular road or where there have been documented claims that vehicles have been driving on the trail. Bollards have become more of a hazard to trail users than users being run over or into by illegal vehicle trespass on multi-use trails. Therefore, bollards should be installed on an as needed basis rather than adding them to every project and crossing of streets. When determined they are needed, access control bollards may be made of any number of materials, including but not limited to: wood, concrete, plastic (PVC), or steel, as appropriate to a particular setting. Sizing should be appropriate for both maximum visibility and as a visual deterrent to motor vehicles. Surfaces of the bollard should be relatively smooth, with no protruding objects to snag on clothing or appendages of passersby. Selection of bollard materials is less important than their placement. If deemed necessary for a particular trail access point, bollards should be placed only in the center of the trail and (if additional protection is necessary), at either edge. For a typical ten-foot trail, this would result in two five-foot-wide accessible openings on either side of the trail centerline. In specific situations where ATV access must be addressed such as within AMAFCA facilities, bollard spacing may be reduced to provide a minimum 36"-wide clear opening on either side of the trail centerline. This will permit wheelchair access, but exclude all but the smallest ATVs (and motorcycles). Bollards should be brightly painted and reflectorized for greater visibility, especially in low light conditions. A specific diamond shaped stripe shall be placed around center bollards per AASHTO (see figure 14). If maintenance and emergency vehicles are expected to gain access via the trail itself, access control bollards should be designed for easy removal or collapse. Otherwise, gates should be provided in adjacent fences or railings to permit such access. Consultation with local authorities is advised in such situations.



*Bollards deter motorists from driving on the trail, but they can be dangerous for cyclists, particularly on a busy trail.*

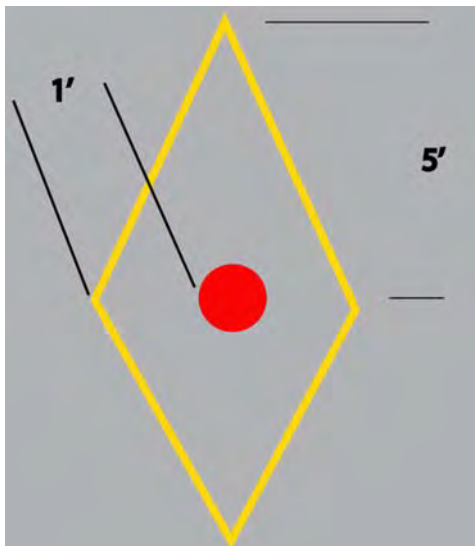


*Bollards and pavement change prevent motor vehicles from using the trail.*



[Although AMAFCA currently requires 36-inch maximum spacing on bollards, the proposed PROWAG standards will require 48-inch spacing. A minimum of 48-inch spacing is required to pass certain types of cycles for ADA use such as those that have parallel seating and are over 36 inches wide.](#)

**Figure 14: Typical Striping around Bollard**



Following is a list of best practices that should be consistent when installing bollards at any trail facility by the City of Albuquerque:

- Only apply bollards if the need is demonstrated, or if the trail entrance cannot be designed or modified to discourage use by unauthorized motor vehicles. Bollard use should be reserved for problematic locations.
  - Bollards should not be installed on trail facilities that parallel a roadway unless it is identified as a problematic location.
  - Bollards should be considered along obscured facilities that are not readily visible and at other problematic locations.
- All bollards should be made of a retro-reflectorized material or have retro-reflectorized tape affixed to them for easy visibility from both approaches to the bollard.
  - Where possible, retractable bollards should be implemented. Appropriate usage ensures that the bollards will remain in place and cannot be removed from the site and when retracted, the bollard will not be a hazard as there is no “collar” that sticks up when the bollard is removed due to this type of bollard retracting into the ground rather than coming off.
- Bollards should be 40 inches in height (minimum) and 4 inches (minimum) in diameter to ensure visibility but short enough to not interfere with handlebars on cycles.

- In most instances, a single bollard should be placed at the centerline of the trail, where adequate sight distance is available.
  - An even number of bollards shall never be used as they typically will be placed in the center of the travel way for each travel direction and they tend to direct users into each other causing confusion.
  - If it is necessary to restrict access adjacent to the multi-use trail to restrict motorized traffic, bollards should be placed a minimum of 2-feet off of the edge of the trail.
- A minimum clear width of 5 feet should be provided between the edge of trail and the edge of the bollard.
- A striped envelope (4 inch wide, retro-reflective yellow “diamond”) should be striped around the bollard to provide guidance to divert users around the bollard. A striped yellow centerline should also be provided along the trail for 25-feet on either side of the bollard. See [figure 14](#)
- Bollards should be set back 30-feet from the roadway to separate the conflict point for users between the roadway and bollards, or as far back as is practical based on site conditions.

These recommendations are consistent with what the Parks and Recreation Trails Planner drafted in 2012 and a draft paper developed by the Greater Albuquerque Recreational Trails Committee (GARTC) (**Appendix C**) as well as ideas coming from a coordination meeting held July 22, 2013. Standards to ensure consistent application should be implemented by all departments of the City of Albuquerque. Every trail and entrance are unique and special consideration will need to be given to each site to determine how best to place bollards, if the need for bollards is demonstrated.

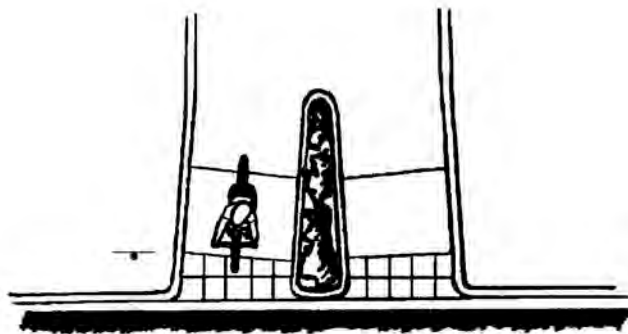
### *Design Considerations & Guidelines*

In recent years, the use of bollards as trailhead access control has become the subject of some debate. Posts or bollards have commonly been used to restrict vehicular access at roadway intersections. In addition, they serve a secondary purpose of warning trail users of the upcoming intersection. On the other hand, bollards also present obstacles for trail users to negotiate, and therefore become potential hazards, particularly in times of low visibility. While there is not yet consensus on the issue, it is increasingly held that in older, established areas of the city, where people are familiar with the existence of non-vehicular trails, bollards may no longer be necessary.

Trailhead access control can also take other forms beyond the use of posts or bollards. An attractive alternative might involve dividing the trail into two one-way paths, half the width of the total trail, with a landscaped median or other central barrier ([Figure 15](#)). The resultant one-way paths are generally narrow enough to discourage vehicular access, while better defining trail movements. The trail could also be divided around power poles or other existing features in order to eliminate the need for adding bollards. This configuration works particularly well with traffic signal poles that incorporate user-activated crosswalk signals.

At the same time, it should be acknowledged that bollards or medians by themselves do not serve as effective deterrents to trail access by motorcycles and smaller all-terrain vehicles (ATVs), which can be a significant nuisance in some areas while also being illegal per City Ordinance. Some years ago, a common solution involved the placement of specially-designed bicycle gates or wheelchair-accessible chicanes across trails to exclude such vehicles. Today, however, the consensus seems to be that such measures are more of a nuisance for legitimate users; especially bicyclists. Instead, enforcement and user vigilance seem to be fairly effective at keeping unauthorized users to a minimum, at least on more heavily-used trails.

**Figure 15: Divided Trail Access with Median**

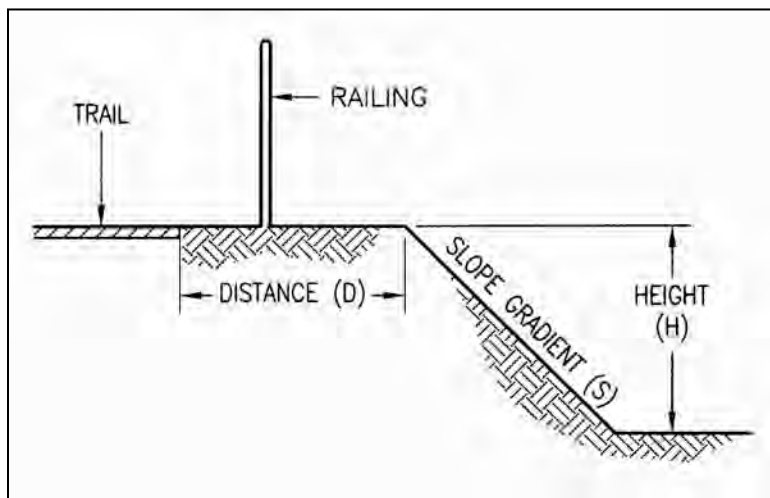


## 5. Fencing & Railings

### *Design Standards*

Figure 16, below, provides criteria for appropriate application of various railing types.

**Figure 16: Railing Warrants**



DISTANCE (D)	SLOPE GRADIENT (S)	HEIGHT (H)	RAILING TYPE
10' or further	any	any	None
5'-10'	3H:1V or flatter	any	None



5'-10'	3H:1V to 1H:1V	12' or more	2-Bar
5'-10'	1H:1V to vertical	6' or more	2-Bar
5' or closer	3H:1V to 2H:1V	6' or more	2-Bar
5' or closer	2H:1V to 1H:1V	4' or more	2-Bar
3'-5'	1H:1V to vertical	1.5' – 4'	4-Bar / 6-Bar
3'-5'	1H:1V to vertical	4' or more	Barrier
3' or closer	1H:1V to vertical	1.5' or more	Barrier

### Design Considerations & Guidelines

#### Railings

**Safety-Protection** railings should be used in situations where trails cross, or are adjacent to, drop-offs, steep slopes, hazardous drainage facilities, or other conditions where the trail user would be ill advised to leave the trail. Railings usually take the form of two-, four-, or six-bar steel pipe railings, depending on the severity of the conditions behind the railing. In cases where extremely hazardous conditions exist along a trail a barrier railing should be used. Barrier railings are those with spaces of six inches or less (or three inch, maximum, openings to comply with U.S. Consumer Product Safety Commission (CPSC) guidelines near playgrounds or other areas frequented by small children). Railings are preferred over fencing in such situations because steel pipe is inherently stronger than most fencing. Railings also present a smoother surface than fencing, which often facilitates recovery if a cyclist wanders off the trail (i.e. brushing against a railing would typically be less catastrophic than catching a handlebar end in a fence mesh).



Post and wire fence.



Open boundaries can be used where users may be entering or existing the trail.

#### Fencing

Fencing along trails serves two purposes: access control and/or screening. Access control fencing usually consists of wire mesh (e.g. field fence), multiple individual wire strands (high-tensile fencing), or simply a single strand of cable suspended between posts (the aptly named “post-and-cable barrier”). Screen fencing, on the other hand, can be comprised of a wide range of materials, but should conform to three main criteria:



- Screen fencing should not be totally opaque; rather it should provide for limited or indirect visibility to and from the trail corridor (e.g. offset “shadow-box” pickets), ~~for safety reasons~~.
- Materials should be strong enough to withstand impacts from trail users in the event of unintentional contact (for instance, vinyl fencing, while decorative, may not be capable of supporting a horse, or even a cyclist, if the fence is hit with any force).
- Fencing along trails should not contain any sharp edges or corners which could serve as snag points or otherwise cause injury to trail users.

## 6. Managing Multiple Users

Trails that experience high levels of use, particularly by a variety of user types, may become overcrowded and ~~unsafe-undesirable~~ for some users. The City should consider widening a high-use trail where feasible; otherwise, treatments such as separating bicycle and pedestrian areas, pavement markings and etiquette signs can improve sharing the trail.

### *Design Standards*

- Stripe a centerline. See guidelines below for specifics.
- Separate bicycle and pedestrian areas where feasible.
- Barrier separation – vegetated buffers or barriers, elevation changes, walls, fences, railings and bollards.
- Distance separation – differing surfaces.
- Install Park and Recreation Department typical trail etiquette signage also known as the “yield to” sign.
- In Major Public Open Space areas, trailheads should have regulation signage as well as the Open Space Division’s trail etiquette or “yield to” signage.

### *Design Considerations & Guidelines*

Centerline striping shall be used to encourage users to stay on a particular side of the trail. Use of thermoplastic material shall be used. The line shall be colored yellow and dashed using 3 foot long skips and 9 foot spacing between dashes. Refer to AASHTO for recommendations when solid center stripes should be used such as on turns or curves. Centerline striping is particularly beneficial in the following circumstances:

- For heavy volumes of bicycles and/or other users,
- On curves with restricted sight distance, and
- On unlighted paths where nighttime riding is expected.
- Differing surfaces suitable to each user group foster visual separation and clarity of where each user group should be. A dirt track can draw runners, equestrians, and walkers to reduce conflicts with cyclists. When trail corridors are constrained, the approach is often to locate the two different trail surfaces side by side with no separation.

The MUTCD contains information about centerline striping.

## **7. Signage**

Development of a consistent signage system is an important element in the creation of a unified and recognizable trail system in metropolitan Albuquerque. Signage can be grouped broadly into two categories: regulatory and informational. Regulatory signage includes warnings, regulations, and directives applicable to trail use in general (Stop, No Motor Vehicles, Trail Etiquette, etc.), while informational signage would refer to a signage package specific to a particular trail and location, providing information such as the trail name (especially at designated trailheads), connections to other trails or facilities (through maps or directional arrows), and distances to key destinations. In an effort to expand trail accessibility, these signs also often include information such as trail length, grades, cross slopes, and obstacles which may be encountered (see Trail Difficulty Rating System on page 6).

### *Design Considerations & Guidelines*

Regulatory signage should be placed where most visible and effective, and should be grouped, where practical and appropriate, to minimize the number of posts (potential obstacles). In some cases, free-standing signs may be replaced by pavement markings, for the same reasons. (A specific example would be to replace “Stop Ahead” signs with the same message painted on the trail surface. See Pavement Markings discussion below.) Sizing and placement should be in accordance with the most recent version of the Federal Highway Administration’s Manual on Uniform Traffic Control Devices (MUTCD) Part 9, Bicycle Facilities. However, the City Parks and Recreation Department has developed a few signs that will give Albuquerque’s paved multi-use trail network its own sense of community and style. See [Figure 20 on page 227](#) for images of the signs the Parks and Recreation Department has implemented since 2013.

Trail signage has been designed with a standardized mounting system and graphic medium which can be easily modified or replaced as the trail system grows. Using the same design scheme throughout the entire Trail Network will help users understand that the network is a large system. For example, if you are on a trail on the west side of the City and see the specific green/blue general regulatory/informational sign as in Figure 17 of this Plan, you will also see this same sign on a trail that is part of the network on the east side of the City. However, creativity and customization of trail-specific information signage is encouraged in addition to having the “network specific” regulatory signage in order to develop individual identities for each trail facility.

### *Pavement Markings*

In general, pavement markings supplement or reinforce the regulatory signage, and are comprised of striping, text, and/or stenciled figures. Centerline striping shall be used to help define directions of travel or separate different user groups on multi-purpose trails and be yellow per AASHTO’s recommendations, while solid white edge striping gives trail users visual reinforcement of the limits of the trail surface, which is particularly valuable in low light conditions (especially if a potentially



hazardous condition exists beyond the edge of the trail). Text is generally intended to convey warnings of changing conditions ahead, although it is sometimes used in place of or in addition to vertical regulatory signage (such as “Yield” signs). Figures usually take the form of arrows or other symbols, or may be used to designate portions of the trail for different modes of travel.

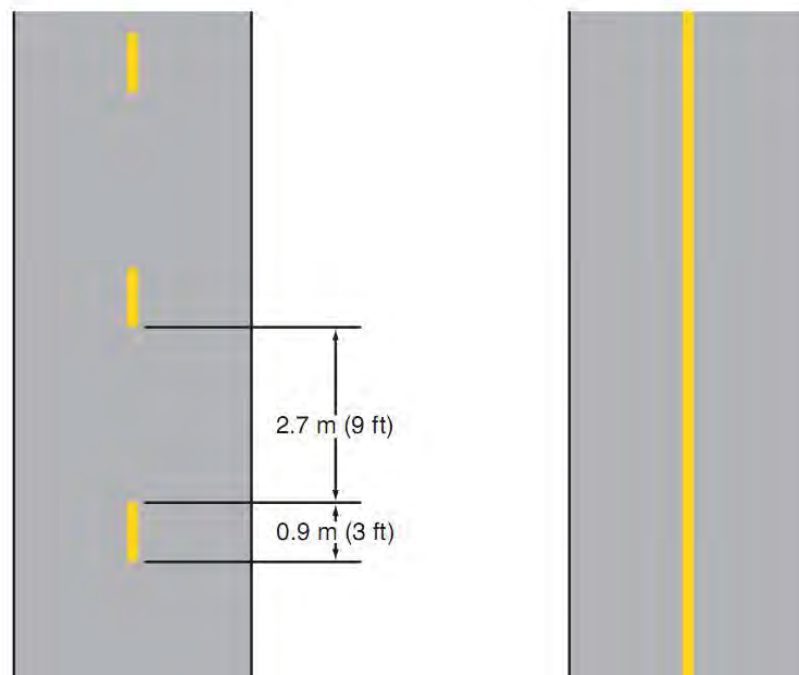
### *Design Considerations & Guidelines*

Striping along a trail should be consistent, as any change in color, thickness or width can be perceived as an indication of an expected change. An example of this would be changing from dashed to solid striping on sharp curves which require cyclists to slow down (as described in the Trail Alignment section above).

Placement of text on the pavement, rather than on post-mounted signs, can reduce potential vandalism and/or graffiti targets; however, they are more easily overlooked, and are easily obscured by snow or wind-blown debris. Therefore, critical signage such as “Stop” signs should still be provided on posts alongside the trail.

Both AASHTO and MUTCD provide additional guidance on striping trail facilities.

**Figure 17: Examples of Centerline Markings for Trails**



## **8. Trail Heads & Amenities**

### ***Trailheads (7.C.8.a)***

Major trailheads should include automobile and bicycle parking, trail information (kiosks including maps, user guidelines and regulations, wildlife information, etc.), garbage receptacles and if possible on a

location by location basis; restrooms and water fountains. Minor trailheads can provide a subset of these amenities.

Good access to a path system is a key element for its success. Trailheads (formalized parking areas) serve the local and regional population arriving to the path system by car, transit, bicycle or other modes. Trailheads provide essential access to the shared-use path system and include amenities like parking for vehicles and bicycles, restrooms (at major trailheads) and posted maps.

All areas of newly designed or newly constructed and altered portions of existing trails connecting to designated trailheads or accessible trails should comply with the most recent and stringent ADA regulations. However, the guidelines do recognize that often the natural environment will prevent full compliance with certain technical provisions. The accessibility audits that the Parks and Recreation Department is working on that started in 2013 will provide an idea of what needs to or can be done to help make trail heads more accessible if and when possible.

*Design Considerations & Guidelines*

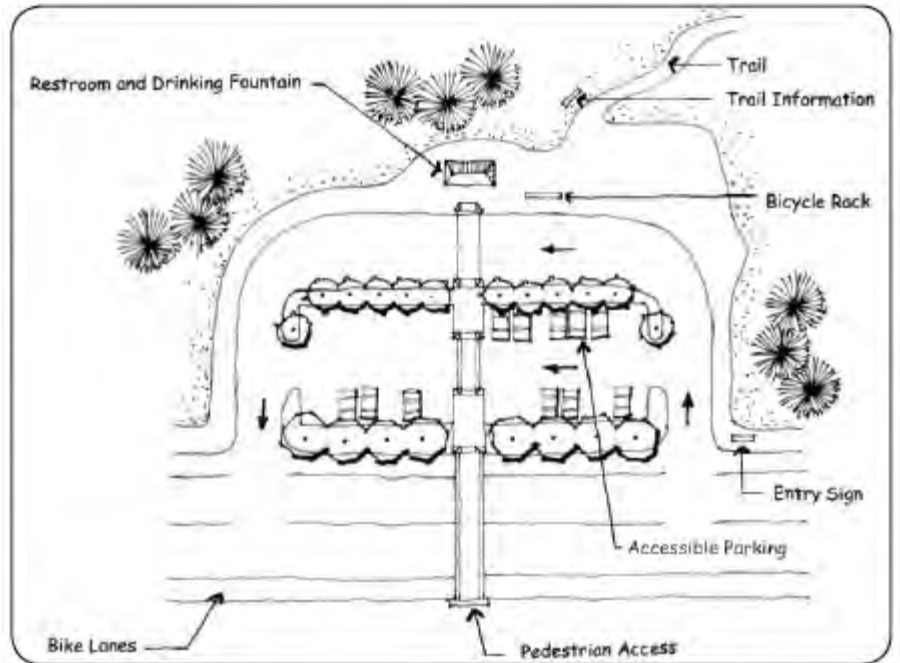
- AASHTO Guide for the Development of Bicycle Facilities. Regulatory Negotiation Committee on Accessibility Guidelines for Outdoor Developed Areas.

**Trailhead Parking (7.C.8.b)**

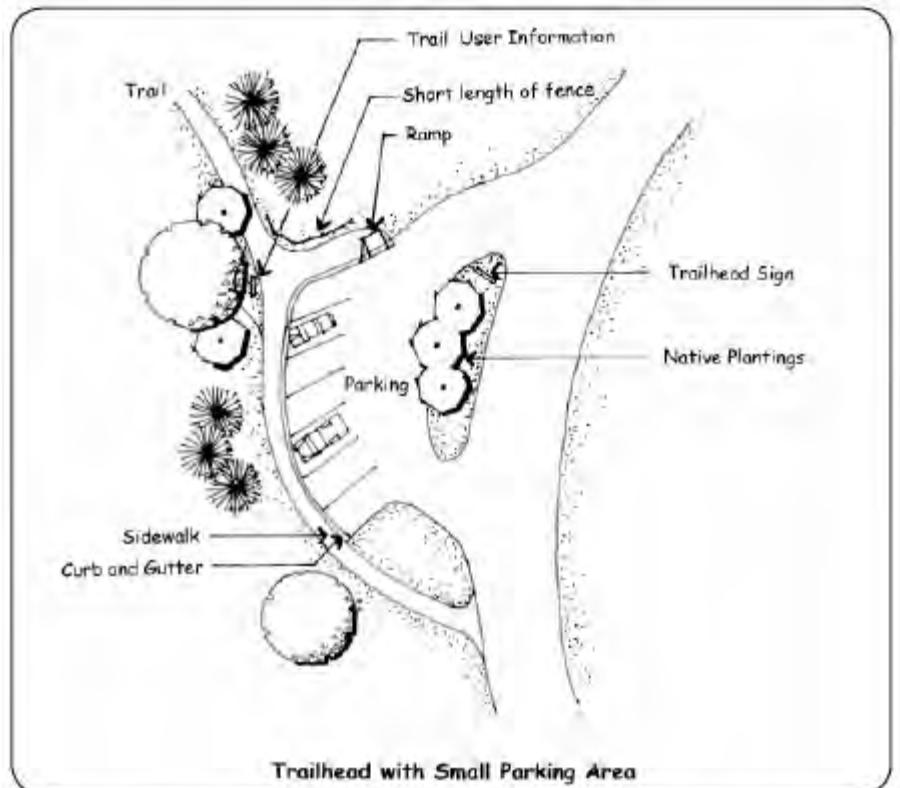
One of the City’s goals is to provide a trail network which offers ready access to and from all parts of the city, thereby enabling a reduction in automobile usage. Nonetheless, due to gaps in that developing system, as well as simple human nature, the fact remains that many people do, and will continue to use vehicles to get to the trails. As a result, it is necessary to provide parking wherever possible at trailheads and other major access points along the City’s trail network.

*Design Considerations & Guidelines*

At a minimum, parking should be provided for cars, with additional spaces provided for horse trailers at trails likely to see equestrian usage. The size/capacity of each parking area should be determined in consultation with the Parks and Recreation Department, and should be based upon projected usage of the trail. Design of the lots should follow parking guidelines set forth in the Development Process Manual (DPM). Parking lots serving accessible trails should have be designed to current ADA standards for parking lots.



Example major trailhead.



Example minor trailhead.

### ***Amenities (7.C.8.c)***

The provision of amenities such as benches and/or tables, trash receptacles, lighting, water fountains, shade structures, industrial type vandal resistant bicycle pumps, and even restrooms tends to make trail use more enjoyable, especially on longer trails. Trail-related amenities can range from minor to major, both in terms of initial installation costs and long term maintenance issues. A major trail improvement might include a restroom facility with a water fountain, as well as benches, bicycle rack, and a trash receptacle. These major amenities should typically be provided in areas with high traffic and, preferably, overlapping uses (e.g. where a trail passes through a park or other public gathering area) in order to maximize return on the investment. Minor improvements, on the other hand, might include benches (or even sitting-height boulder groupings) or trash receptacles, alone or in combination, situated at intervals along the trail. Shade structures – always welcome in the Southwest climate – and directional signage packages fall in the mid-range of the amenity scale.



*Recommended pedestrian-scale lighting.*

Lighting may be used for visual accent, as well as providing additional security in areas of concern, such as tunnels or other isolated locations. Fixtures should be vandal resistant and should be placed where they most effectively illuminate the trail (or key features within the corridor), without shining in trail users' eyes. They should also be designed and/or located in such a way as to shield nuisance light and minimize impact on adjacent properties. AASHTO provides additional recommendations for lighting in its Guide for the Development of Bicycle Facilities. For the 50 Mile Activity Loop amenities and other information, please refer to that specific Plan.

### ***Design Considerations & Guidelines***

Development of trail amenities should follow a conscious plan whereby major amenities are grouped in nodes at key locations, while minor amenities are consistently found along the length of each trail. Styles of amenities should be compatible with adjacent development or closely allied with other amenities found along the length of the trail, in a thematic arrangement. Materials for benches, trash receptacles, tables, and such, must be of durable materials and should be designed (or coated) for easy graffiti removal. Introduction of bicycle pumps used to inflate soft or flat tires will start in 2014. Use of recycled materials is encouraged wherever possible. Coordination with the City's Park Management Division is also encouraged during the material selection process, in order to ensure that maintenance issues are adequately addressed.



## ***Landscaping (7.C.8.d)***

### *Design Considerations & Guidelines*

Landscaping along trails typically will fall into one of two categories: revegetation or enhancement. At a minimum, disturbed land within trail corridors should be re-seeded with native grasses (and wildflowers, where appropriate) according to Section 1012 of the City Standard Specifications. Those specifications list two generic seed mixes (for sand or clay soils) which may be used city-wide, with the condition that the shrub component (four-wing saltbush, etc.) be eliminated from seeding alongside recreational trails unless more than 5 feet away from edge of trail (however, the inclusion of xeric shrubs in the seed mix may be desirable for slope stabilization in areas of significant cut or fill). As an alternative to those generic mixes, trail developers may use a more site-specific mix, specified by the project landscape architect, Planner, or in consultation with the City Open Space Division. The addition of wildflower seed to a revegetation mix will provide color and seasonal interest to the trailside, and is particularly effective where the seeding can take advantage of any available supplemental water (e.g. sprinkler overspray from adjacent properties, collected storm water, etc.). Specifically where goat heads (puncture vine) are present or a nuisance, native plants that can out-compete the goat heads should be considered.

More intensive “enhancement” landscaping may be appropriate for high use areas; perhaps at an important trailhead, through a neighborhood development, or in conjunction with a major trail amenity/improvement as identified above. The viability of such landscaping is dependent upon the availability of water and electricity (or alternative power) for an irrigation system, and the establishment of a maintenance agreement with the City Parks Department or a private entity, prior to implementation.

Regardless of the type of landscaping considered, shoulder and clear-zone requirements (as identified earlier in the Trail Dimensions section) shall be followed. Native seeding should be kept back two feet from the edge of the trail (unless it is strictly grasses), in most cases, to allow for the graded, compacted shoulders. Trees are encouraged along trails for the shade that they provide; however, they should be planted at least 6-10 feet back from the edge of trail (to maintain the three-foot clear zone at maturity), and further, if possible, to minimize root damage to the trail surface. Likewise, shrubs should be located such that their branches do not interfere with the trail as they mature. Plant materials in general should be selected for people- and trail-friendly characteristics: thorny plants, trees which tend to drop messy fruit/seeds/pods (which could affect surface traction), and heavy pollen-producers should not be used alongside trails. Native, non-invasive, low water use trees whose roots go downward rather than outward are highly recommended and encouraged next to shared-use paths.

### ***Safety & Visibility (7.C.8.e)***

In addition to design factors such as stopping sight distances and trail widths, **safe**-trail design must also take into consideration geographical and environmental factors such as local weather conditions, location (surroundings), and visibility. There is usually a strong correlation between a trail user's sense of **safety-security** and the level of visibility, both into and out from the trail. Therefore, trail designers should strive to maintain a balance between the privacy of adjacent landowners, and **safety-security** concerns of trail users. **Safety and s**Security concerns on a trail can be addressed through Crime Prevention through Environmental Design (CPTED) guidelines.

### **Crime Prevention through Environmental Design (CPTED)**

The four principles of CPTED are:

- Natural surveillance – maintaining sight lines and visibility to deter criminal activities.
- Natural access control utilizes fences, lighting, signage and landscape to clearly define where people and vehicles are expected to be.
- Territorial reinforcement – use physical designs such as pavement treatments, landscaping and signage to develop a sense of proprietorship over the trail.
- Maintenance - if graffiti or vandalism occurs and is not repaired replaced right away, it can send the message that no one is watching or that no one cares.

### ***Design Considerations & Guidelines***

Design considerations for maximizing visibility include location, height, and type of fencing (see Access Control section below); clear lines of sight into and through tunnels, underpasses, and bridges; elimination of blind corners at intersections and other locations; and the addition of lighting in appropriate areas.

Weather-related **safety**-design consists primarily of maximizing solar orientation to minimize dangers from ice and snow accumulation. In some cases, protection from potentially gusty winds may be appropriate for open, exposed stretches of trail. Discussion of potential **safety issues hazardous conditions** related to storm water runoff is contained in the Drainage section below.



*Rest stops should provide garbage receptacles to minimize littering.*



*Surveillance from nearby buildings and pedestrian-scale lighting can increase shared-use path safety.*

### **Privacy of adjacent property owners**

- Encourage the use of neighborhood friendly fencing and also planting of landscape buffers.
- Clearly mark path access points.
- Post path rules that encourage respect for private property.
- Strategically placed lighting.

### **Unwanted vehicle access**

- Utilize landscaping to define the corridor edge and path, including earth berms or boulders.
- Use bollards at intersections as needed and as outlined in various bollard assessments, future policies, and AASHTO.
- Pass a motorized vehicle prohibited ordinance and sign the path.
- Create a Trail Watch Program and encourage citizens to photograph and report illegal vehicle use of the corridor. Authorized vehicles are not considered “illegal” vehicle trespass.
- Lay the shared-use path out with curves that allow bike/pedestrian passage but are uncomfortably tight for automobile passage

### **Litter and dumping**

- Post rules encouraging pack it in/pack-it-out practices.
- Place garbage receptacles at trailheads.
- Strategically placed lighting, utilizing light shields to minimize unwanted light in adjacent homes.
- Manage vegetation to allow visual surveillance of the path from adjacent properties and from roadway/path intersections.
- Encourage local residents to report incidents as soon as they occur.
- Remove dumpsites as soon as possible.

### **Trespassing**

- Clearly distinguish public path right-of-way from private property through the use of vegetative buffers and the use of good neighbor type fencing.
- Post rules encouraging respect for property.

### **Local on-street parking**

- Designate residential streets as parking for local residents only to discourage user parking.
- Place “no outlet” and “no parking” signs prior to path access points.
- Accessible parking should be provided when feasible.

### **Crime**

- Manage vegetation to ensure visibility from adjacent streets and residences.
- Place lights strategically and as necessary.
- Place benches and other amenities at locations with good visual surveillance and high activity.
- Provide mileage markers every 1/4 mile and clear directional signage for orientation.

- Create a “Trail Watch Program” involving local residents.
- Encourage proactive law enforcement on the trail.

### Vandalism

- Select benches, bollards, signage and other site amenities that are durable, low maintenance and vandal resistant.
- Respond through removal or replacement.
- Keep a photo record of all vandalism when possible and turn it over to local law enforcement.
- Encourage local residents to report vandalism.
- Create a Trail Watch Program and maintain good surveillance of the corridor.
- Involve neighbors in trail projects to build a sense of ownership.
- Place amenities in well used and visible areas.

### Visibility

There is usually a strong correlation between a trail user’s sense of safety-security and the level of visibility, both into and out from the trail. Therefore, trail designers should strive to maintain a balance between the privacy of adjacent landowners, and safety-security concerns of trail users.

Design considerations for maximizing visibility include:

- the location, height, and type of fencing (see Access Control section);
- clear lines of sight into and through tunnels, underpasses, and bridges;
- elimination of blind corners at intersections and other locations; and
- addition of lighting in appropriate areas.

### Community Involvement with Safety on the to Make Trails a Better Place

Creating a safe-secure trail environment goes beyond design and law enforcement and should involve the entire community. The most effective and most visible deterrent to illegal activity on Albuquerque’s trail system will be the presence of legitimate path users. Getting as many “eyes on the corridor” as possible is a key deterrent to undesirable activity.

- **Good access to the path** - Access ranges from providing conveniently located trailheads along the trail to encouraging the construction of sidewalks to accommodate access from private developments adjacent to the trail. Access points should be inviting and signed so as to welcome the public onto the trail.
- **Good visibility from neighbors** - Neighbors adjacent to the trail can potentially provide 24-hour surveillance of the trail and can become Albuquerque’s biggest ally. Though some screening and setback of the path is needed for privacy of adjacent neighbors; complete blocking out of the trail from neighborhood view should be discouraged. This eliminates the potential of neighbors’ “eyes on the trail” and could result in a “tunnel effect” on the trail.



- **High level of maintenance** - A well-maintained trail sends a message that the community cares about the public space. This message alone will discourage undesirable activity along the trail.
- **Programmed events** - Community events along the trail will help increase public awareness and thereby attract more people to use the trail. Neighbors and residents can help organize numerous public events along the path which will increase support for the path. Events might include a day-long path clean up or a series of short interpretive walks led by long-time residents or a park naturalist.
- **Adopt-a-trail Program** - Nearby businesses, community institutions and residential neighbors often see the benefit of their involvement in trail development and maintenance. Businesses and developers may view the trail as an integral piece of their site planning and be willing to take on some level of responsibility for the trail.
- **Trail Watch Program** - Partnering with local and county law enforcement, a trail watch program would provide an opportunity for local residents to become actively involved in crime prevention along Albuquerque's trail system. Similar to Neighborhood Watch programs, residents are brought together to get to know their neighbors and are educated on how to recognize and report suspicious activity. Although this section is related to ~~safety~~ better awareness, trail watch programs do not solely need to be tied to crime prevention. Many people can report fun items in trail watch reports such as different wildlife and bird sightings and other nature specific items such as interesting native vegetation as well as where noxious weeds are located.

## DE. General Intersection Design Guidelines

A wide variety of intersection treatments exist, which provide safe-better crossing for bicyclists and pedestrians. Treatments specific to particular facility types were previously discussed. This section addresses general guidelines for crossings.

### 1. High-Visibility Crosswalk Techniques

Additional treatments can be used to increase visibility of the crosswalk at high-use locations and in locations with high use from school children, elderly pedestrians or pedestrians with disabilities.

#### Flasher Warning Sign

Flashing warning signs increase the visibility of a crossing by calling attention to the pedestrian crossing location. They can be continuous, timed for rush hours or activated by a pedestrian push-button. MUTCD Chapter 4L provides information about flashing beacons.



Flashing warning sign.

#### Raised Median (Non-standard treatment)

A median can eliminate grade changes from the pedestrian path and give pedestrians greater prominence as they cross the street. Raised crosswalks should be used only in limited cases where a special emphasis on pedestrians is desired such as at a mid-block crossing. Review on case-by-case basis.



Raised medians require drivers to slow down.

#### Design Considerations & Guidelines

- Use detectable warnings at the curb edges to alert vision-impaired pedestrians that they are entering the roadway.
- Approaches to the raised crosswalk may be designed to be similar to speed humps, or they may be designed so they do not have a slowing effect (such as on emergency response routes).
- Use post mounted pedestrian crosswalk signs placed on the median and on the right side of the roadway for each approach.



In-street yield to pedestrian signage.

## In-Street “Yield to Pedestrians” Signs and Flashers

In-street “Yield to Pedestrian” signs are flexible plastic paddle signs installed in the center of a roadway to enhance a crosswalk at uncontrolled crossing locations. In-pavement flashers may be appropriate on undivided roadways in densely developed areas that do not offer median refuges for crossing pedestrians. See MUTCD Section 2B.12 In-Street and Overhead Pedestrian Crossing Signs.

## In-Roadway Lights

In-roadway lights may be used at marked crosswalks to provide additional warning. They are actuated by the pedestrian and flash for a designated amount of time before turning off. See MUTCD Section 4N.02 In-Roadway Warning Lights at Crosswalks for additional information.

- United States Access Board. (2007). Public Rights-of-Way Accessibility Guidelines (PROWAG).
- MUTCD

## Marked Crosswalks

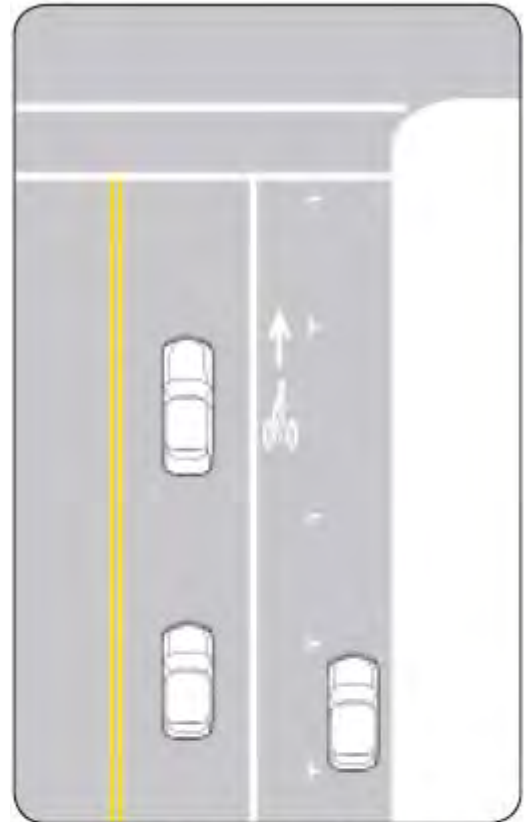
### 2. Minimizing Conflict with Automobiles

Separating pedestrians and motor vehicles at intersections improves ~~safety and~~ visibility.

### Design Considerations & Guidelines

#### Parking Control

- Parking control improves visibility in the vicinity of the crosswalk. Parking is prohibited within all intersections and crosswalks unless otherwise signed. At “T” and offset intersections, where the boundaries of the intersection may not be obvious, this prohibition should be made clear with signage.
- In areas where there is high parking demand (as determined by a Traffic Engineer), parking for compact vehicles may be allowed within “T” or offset intersections and on either side of the crosswalk. At these locations, signs will be placed to prohibit parking within the designated crosswalk areas and additional enforcement should be provided, particularly when the treatment is new.
- Parking shall not be allowed within any type of intersection adjacent to schools, school crosswalks and



Crosswalks should always be kept clear of on-street parking.



Advance stop bars alert motorists of pedestrians.

parks. This includes “T” and offset intersections.

- Installation of parking signage to allow and/or prohibit parking within any given intersection will occur at the time that the parking control section is undertaking work at the intersection.

### Advance Stop Bars

Advance stop bars increase pedestrian comfort ~~and safety~~ by stopping motor vehicles well in advance of marked crosswalks, allowing vehicle operators a better line of sight of pedestrians and giving inner lane motor vehicle traffic time to stop for pedestrians. Pedestrians feel more comfortable since motor vehicles are not stopped adjacent to the crosswalk. The multiple threat of motor vehicles is reduced, since vehicles in the inner travel lane have a clearer line of sight to pedestrians entering the sidewalk. Without an advance stop bar, the vehicle in the outer lane may stop for the pedestrian, but the vehicle in the inner lane proceeds, increasing the possibility of a vehicle-pedestrian conflict.

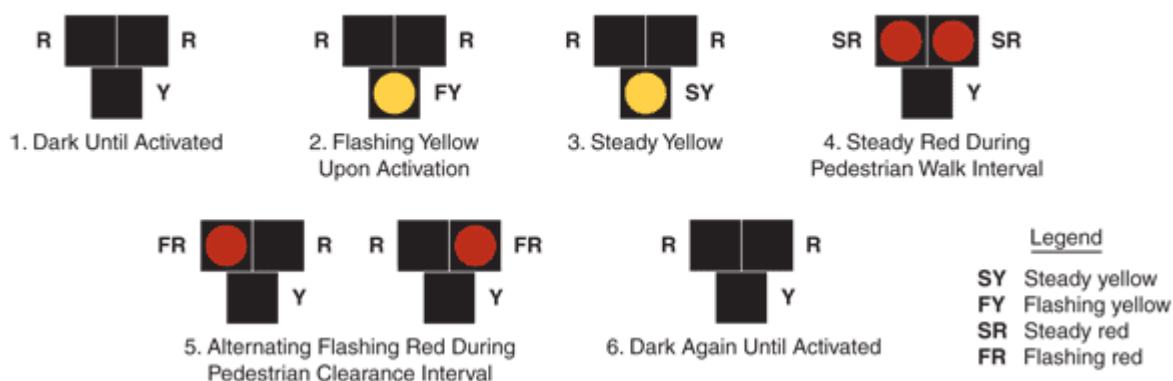
Advanced stop bars should be used:

- On streets with at least two travel lanes in each direction.
- Prior to a marked crosswalk
- In one or both directions of motor vehicle travel
- Recommended 30 feet in advance of the crosswalk.
- A “Stop Here for Pedestrians” sign must accompany the advance stop bar.

United States Access Board. (2007). Public Rights-of-Way Accessibility Guidelines (PROWAG).

### Pedestrian Hybrid Beacon

Figure 4F-3. Sequence for a Pedestrian Hybrid Beacon



Sequence for a pedestrian hybrid beacon (MUTCD Figure 4F-3).

Guidance from the MUTCD Section 4F. Pedestrian Hybrid Beacons:

- The pedestrian hybrid beacon should be installed at least 100 feet from side streets or driveways that are controlled by a STOP or YIELD sign.



- Parking and other sight obstructions should be prohibited for at least 100 feet in advance of and at least 20 feet beyond the marked crosswalk, or site accommodations should be made through curb extensions or other techniques to provide adequate sight distance.
- The installation should include suitable standard signs and pavement markings.
- If installed within a signal system, the pedestrian hybrid beacon should be coordinated.



Pedestrian hybrid signal; also called HAWK signals (High-Intensity Activated Crosswalk).

### *Design Considerations & Guidelines*

A pedestrian hybrid beacon may be considered for installation to facilitate pedestrian crossings at a location that does not meet traffic signal warrants (see MUTCD Chapter 4C) or at a location that meets traffic signal warrants but where a decision is made to not install a traffic control signal.

The beacon signal consists of a traffic signal head with a red-yellow-red lens. The unit is off until activated, then the signal phasing is:

- The signal flashes yellow to warn approaching drivers.
- A solid yellow advises drivers to prepare to stop.
- The signal changes to a solid red and a WALK indicator is shown.
- The beacon signal converts to an alternating flashing red, allowing the drivers to proceed after stopping at the crosswalk, while the bicyclist or pedestrian is shown the flashing DON'T WALK signal.



Scramble signals allow cyclists to cross a intersection diagonally.

### **Scramble Signals (Non-standard treatment)**

Scramble signals can be used at intersections with frequent vehicle/bicycle conflicts and/or at intersections experiencing high bicycle turning movements (especially left turns that force bicyclists to cross vehicle traffic). Scramble signals provide a simultaneous “All Red” phase for motorists and a green phase dedicated for bicycle/pedestrian movements that enables non-motorized users to cross an intersection using their desired travel path (straight or diagonal).

Scramble signals have been used successfully in Davis, Calif.; Honolulu, Hawaii; and Portland, Ore.

### *Guidance*

- MUTCD Section 4F. Pedestrian Hybrid Beacons

- Bureau of Highway Operations (2010) HAWK Pedestrian Signals: A Survey of National Guidance, State Practice and Related Research  
<http://on.dot.wi.gov/wisdotresearch/database/tsrs/tsrhawksignals.pdf>
- National Cooperative Highway Research Program (2006). Improving Pedestrian Safety at Unsignalized Crossings, Report 562, 2006.  
[http://onlinepubs.trb.org/onlinepubs/nchrp/nchrp\\_rpt\\_562.pdf](http://onlinepubs.trb.org/onlinepubs/nchrp/nchrp_rpt_562.pdf)

### 3. Accommodating Bicyclists at Intersections

At signalized intersections, cyclists should be able to trigger signals when cars are not present. Requiring cyclists to dismount to press a pedestrian button is inconvenient and requires the cyclist to merge in into traffic at an intersection. It is particularly important to provide bicycle actuation in a left-turn-only lane where cyclists regularly make left turn movements.

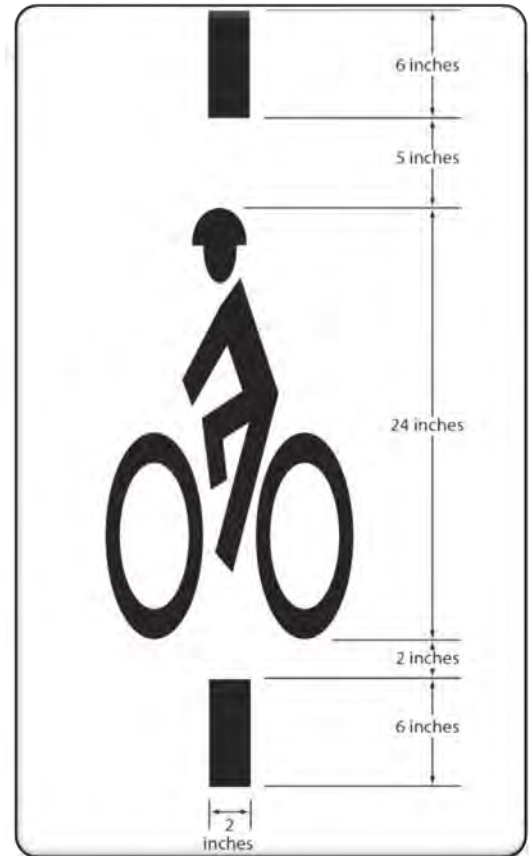
#### *Design Considerations & Guidelines*

##### **Loop Detectors**

- Bicycle-activated loop detectors are installed within the roadway to allow the presence of a bicycle to trigger a change in the traffic signal. This allows the cyclist to stay within the lane of travel and avoid maneuvering to the side of the road to trigger a push button.
- Most demand-actuated signals in Albuquerque currently use loop detectors, which can be attuned to be sensitive enough to detect any type of metal, including steel and aluminum.
- Current and future loops that are sensitive enough to detect bicycles should have pavement markings to instruct cyclists how to trip them, as well as signage (see right).

##### **Detection Cameras**

Video detection cameras can also be used to determine when a vehicle is waiting for a signal. These systems use digital image processing to detect a change in the image at the location. Cameras can detect bicycles, although cyclists should wait in the center of the lane, where an automobile



Recommended loop detector marking design.



Instructional Sign (MUTCD Sign R10-15).

would usually wait, in order to be detected. Video camera system costs range from \$20,000 to \$25,000 per intersection.

Detection cameras are currently used for cyclists in the City of San Luis Obispo, Calif., where the system has proven to detect pedestrians as well.

### **Remote Traffic Microwave Sensor Detection (RTMS) (Non-standard treatment)**

RTMS is a system developed in China that uses frequency modulated continuous wave radio signals to detect objects in the roadway. This method is marked with a time code which gives information on how far away the object is. The RTMS system is unaffected by temperature and lighting, which can affect standard detection cameras.

### **Push Buttons**

A pushbutton is a four-foot pedestal pole next to the curb for a cyclist to actuate the signal. Push buttons should only be used in locations without right turn bays and can be used with or without bike lanes.

#### *Guidance*

- Additional technical information is available at:  
[www.humantransport.org/bicycledriving/library/signals/detection.htm](http://www.humantransport.org/bicycledriving/library/signals/detection.htm)
- ITE Guidance for Bicycle—Sensitive Detection and Counters: <http://www.ite.org/councils/Bike-Report-Ch4.pdf>

## **4. Trail Intersections and Crossings**

At-grade path/roadway crossings generally will fit into one of four basic categories:

- Type 1: Marked/Unsignalized-Unprotected crossings include trail crossings of residential, collector and sometimes major arterial streets or railroad tracks.
- Type 1+: Marked/Enhanced - Unsignalized intersections can provide additional visibility with flashing beacons and other treatments.
- Type 2: Route Users to Existing Signalized Intersection - Trails that emerge near existing intersections may be routed to these locations, provided that sufficient protection is provided at the existing intersection.
- Type 3: Signalized/Controlled - Trail crossings that require signals or other control measures due to traffic volumes, speeds and trail usage.
- Type 4: Grade-Separated Crossings - Bridges or under- crossings provide the maximum level of [safety-security](#) but also generally are the most expensive and have right-of-way, maintenance and other public [safety-security](#) considerations.

#### *Design Considerations & Guidelines*

At-grade crossings are the most widespread method of accommodating trail/ roadway intersections. As with separate-use trail facilities, the high costs and right-of-way needs associated with grade-separated

crossings often preclude their use. Even when built, grade-separated crossings often go unused, for a variety of reasons. Experience has shown that most individuals prefer a direct route of travel, and will not detour even a short distance to use a grade-separated structure, if there are other at-grade possibilities, even if the more direct route saves only a small amount of time. However, at-grade crossings are also the most dangerous, because of one simple fact: trail users and motor vehicles must share the same space. The relative safety-security of any at-grade crossing is dependent on a number of factors, and the ability of the trail user to quickly evaluate those factors and determine an adequate “window of opportunity” for making a safe crossing. Those factors include:

- Walking, riding, or rolling speed (which varies widely among trail users)
- Vehicular traffic speed and volume
- Number of lanes to be crossed
- Traffic signal intervals (where applicable)
- Demographics such as gender and age



*An offset crossing forces pedestrians to turn and face the traffic they are about to cross.*

Since most, if not all, of these factors are beyond the control of the trail designer, at-grade crossings should be laid out so as to maximize the opportunities for trail users to safely-adequately negotiate them. Design features such as median refuges, smooth surface transitions at curb ramps and pavement joints, adequate sight distances, and warning signs should be incorporated wherever possible. (Under current policies, crosswalks are not recommended, except at signalized intersections and past studies have shown that they might give trail users a false sense of security and encourage them to cross without regard to traffic. However, newer studies and discussions show that mid-block crossings and other at-grade crossings not at intersections may be beneficial to the user if they are striped. This typically is more useful for crossings with fewer lanes.)The AASHTO Guide deals fairly extensively with design issues related to trail intersections.

While at-grade crossings create a potentially high level of conflict between path users and motorists, well-designed crossings have not historically posed a safety-problem for path users. This is evidenced by the thousands of successful paths around the United States with at-grade crossings. In most cases, at-grade path crossings can be properly designed to a reasonable degree of safety-protection and can meet existing traffic and safety-standards.

Evaluation of path crossings involves analysis of vehicular and anticipated path user traffic patterns, including:

- Vehicle speeds



- Traffic volumes (average daily traffic, peak hour traffic).
- Street width
- Path user profile (age distribution, destinations served)
- Sight distance

Crossing features for all roadways include warning signs both for vehicles and path users. Consideration must be given for adequate warning distance based on vehicle speeds and line of sight, with visibility of any signing absolutely critical. Catching the attention of motorists jaded to roadway signs may require additional alerting devices such as a flashing light, roadway striping or changes in pavement texture. Signing for path users must include a “STOP” sign and pavement marking, sometimes combined with other features such as bollards.

*Guidance*

The proposed intersection approach that follows is based on established standards, published technical reports and experiences from cities around the country.

Summary of Path/Roadway At-Grade Crossing Recommendations

Roadway Type	Vehicle ADT ≤ 9,000			Vehicle ADT > 9,000 to 12,000			Vehicle ADT > 12,000 to 15,000			Vehicle ADT >>15,000		
	30	35	40	30	35	40	30	35	40	30	35	40
2 Lanes	1	1	1/1+	1	1	1/1+	1	1	1	1	1/1+	+/3
3 Lanes	1	1	1/1+	1	1/1+	1/1+	1/1+	1/1+	1/1+	1/1+	1+/3	1/3
Multi-Lane (4+) w/raised median***	1	1	1/1+	1	1/1+	1+/3	1/1+	1/1+	1+/3	1+/3	1+/3	1+/3
Multi-Lane (4+) w/o raised median***	1	1/1+	1+/3	1/1+	1/1+	1+/3	1+/3	1+/3	1+/3	1+/3	1+/3	1+/3

\*General Notes: Crosswalks should not be installed at locations that could present an increased risk of pedestrians, such as where there is poor sight distance, complex or confusing designs, a substantial volume of heavy trucks, or other dangers, without first providing adequate design features and/or traffic control devices. Adding crosswalks alone will not make crossing safer, nor will they necessarily result in more vehicles stopping for pedestrians. Whether or not marked crosswalks are installed, it is important to consider other pedestrian facility enhancements (e.g. raised median, traffic signal, roadway narrowing, enhanced overhead lighting, traffic-calming measures, curb extensions), as needed, to improve the safety of the crossing. These are general recommendations; good engineering judgment should be used in individual cases for deciding which treatment to use.

For each pathway-roadway crossing, an engineering study is needed to determine the proper location. For each engineering study, a state review may be sufficient at some locations, while a more in-depth study of pedestrian volume, vehicle speed, sight distance, vehicle mix, may be needed at other sites.

\*\*Where the speed limit exceeds 40mph marked crosswalks alone should not be used at un-signalized locations.

\*\*\*The raised median or crossing island must be at least 4ft (1.2m) wide and 6ft (1.8m) long to adequately serve as a refuge area for pedestrians in accordance with MUTCD and AASHTO guidelines. A two-way center turn lane is not considered a median.

1 = Type 1 Crossing. Ladder-style crosswalks with appropriate signage should be used.

1/1+ = With the higher volumes and speeds, enhanced treatments should be used, including marked ladder style crosswalks, median refuge, flashing beacons and/or in-pavement flashers. Ensure there are sufficient gaps through signal timing, as well as sight distance.

1+/3 = Carefully analyze signal warrants using a combination of Warrant 4, Pedestrian Volume or 5, School Crossing (depending on school presence) and Equivalent Adult Unit (EAU) factoring (see MUTCD, Chapter 4). Make sure to project pathway usage based on future potential demand. Consider Pelican, Puffin, or Hawk signals in lieu of full signals. For those intersections not meeting warrants or where engineering judgment or cost recommends against signalization, implement Type 1 enhanced crosswalk markings with ladder style crosswalks, median refuge, flashing beacons and/or in-pavement flashers. Ensure there are sufficient gaps through signal timing, as well as sight distance.

**Type 1: Marked/Unsignalized Crossings**

A marked/unsignalized crossing (Type 1) consists of a crosswalk, signage and often no other devices to slow or stop traffic. The approach to designing crossings at mid-block locations depends on an evaluation of vehicular traffic, line of sight, path traffic, use patterns, vehicle speed, road type and width and other safety-related issues such as proximity to schools. The following thresholds recommend where unsignalized crossings may be acceptable:

**Maximum traffic volumes:**

- ≤9,000-12,000 Average Daily Traffic (ADT) volumes.
- Up to 15,000 ADT on two-lane roads, preferably with a median.
- Up to 12,000 ADT on four-lane roads with median.

**Maximum travel speed:**

- 35 mph.

**Minimum line of sight:**

- 25 mph zone: 155 feet
- 35 mph zone: 250 feet
- 45 mph zone: 360 feet

*Design Considerations & Guidelines*

If well-designed crossings of multi-lane higher-volume arterials over 15,000 ADT may be unsignalized with features such as a combination of some or all of the following: excellent sight distance, sufficient crossing gaps (more than 60 per hour), median refuges and/or active warning devices like flashing beacons or in-pavement flashers. These are referred to as “Type 1 Enhanced” (Type 1+). Such crossings would not be appropriate; however, if a significant number of schoolchildren used the path.

Furthermore, both existing and potential future path usage volume should be taken into consideration.

On two-lane residential and collector roads below 15,000 ADT with average vehicle speeds of 35 mph or less, crosswalks and warning signs (“Path Xing”) should be provided to warn motorists, and stop signs and slowing techniques (bollards/geometry) should be used on the path approach. Curves in paths that orient the path user toward oncoming traffic are helpful in slowing path users and making them aware of oncoming vehicles. Care should be taken to keep vegetation and other obstacles out of the sight line for motorists and path users. Engineering judgment should be used to determine the appropriate level of traffic control and design.

On roadways with low to moderate traffic volumes (<12,000 ADT) and a need to control traffic speeds, a raised crosswalk may be the most appropriate crossing design to improve pedestrian visibility ~~and safety~~. These crosswalks are raised 3 inches above the roadway pavement (similar to speed humps) to an elevation that matches the adjacent sidewalk. The top of the crosswalk is flat and typically made of asphalt, patterned concrete or brick pavers. Brick or unit pavers should be discouraged because of potential problems related to pedestrians, bicycles and ADA requirements for a continuous, smooth, vibration-free surface. Detectable warning strips are needed at the sidewalk/street boundary so



Type 1 Crossing

that visually impaired pedestrians can identify the edge of the street.

### ***Type 2: Route Users to Existing Signalized Intersection***

Crossings within 250 feet of an existing signalized intersection with pedestrian crosswalks are typically diverted to the signalized intersection ~~for safety purposes to lessen potential hazards~~. For this option to be effective, barriers and signing may be needed to direct shared-use path users to the signalized crossings. In most cases, signal modifications would be made to add pedestrian detection and to comply with ADA.

### ***Type 3: Signalized/Controlled Crossings***

New signalized crossings may be recommended for crossings that meet pedestrian, school or modified warrants, are located more than 250 feet from an existing signalized intersection and where 85th percentile travel speeds are 40 mph and above and/or ADT exceeds 15,000 vehicles. Each crossing, regardless of traffic speed or volume, requires additional review by a registered engineer to identify sight lines, potential impacts on traffic progression, timing with adjacent signals, and capacity ~~and safety~~.

#### **Mid-block Crosswalk**

Mid-block crossings provide a crossing opportunity where there is no intersection. At controlled mid-block crossing locations, crosswalks are marked where there is a demand for crossing and there are no nearby marked crosswalks. At uncontrolled crossing use FHWA report HRT-04-100 as guidance of when to mark a crosswalk. Mid-block crosswalks should always be accompanied with pavement markings and warning signs to inform drivers of the approaching crosswalk.

### ***Type 4: Grade-separated Crossings***

Grade-separated crossings may be needed where existing bicycle/pedestrian crossings do not exist, where ADT exceeds 25,000 vehicles and where 85th percentile speeds exceed 45 mph. Safety-The potential for crashes is a major concern with both overcrossings and under-crossings. In both cases, shared-use path users may be temporarily out of sight from public view and may have poor visibility themselves. Under-crossings, like parking garages, have the reputation of being places where crimes



Type 3 Crossing.



Mid-block crosswalk.



Landscaping improves the walking and bicycling experience, and can deter vandalism.



occur. Most crime on shared-use paths, however, appears to have more in common with the general crime rate of the community and the overall usage of the shared-use path than any specific design feature.

Design and operation measures are available which can address shared-use path user concerns. For example, an undercrossing can be designed to be spacious, well-lit, equipped with emergency cell phones at each end and completely visible for its entire length prior to entering. Under-crossings should include lighting, particularly where nighttime security is a potential issue. AASHTO recommends average maintained horizontal illumination levels of 5 lux to 22 lux, depending on the location.

Other potential problems with under-crossings include conflicts with utilities, drainage, flood control and maintenance requirements. Overcrossings pose potential concerns about visual impact and functional appeal, as well as space requirements necessary to meet ADA guidelines for slope.

Grade-separated crossings take two forms: above-grade (bridges), or below-grade (tunnels/underpasses/notches). The decision to use one or the other is driven primarily by topography, although availability of right-of-way and cost of the structure ~~and safety~~ must also be taken into account. In either case, many of the same basic design criteria should be applied to make the crossing as ~~safe and~~ efficient as possible:

- Align the crossing structure with connecting trail facility, to the extent possible while minimizing detours and/or switchbacks– see discussion under At-Grade Crossings above.
- Maintain good visibility into – and preferably all the way through – the structure.
- Provide adequate clear width to carry trail tread plus shoulders across or through the structure, if possible. In a tunnel situation, additional “elbow room,” such as that afforded by elliptical culverts, helps to alleviate the sense of claustrophobia sometimes associated with narrower underpasses.
- Minimize approach ramp grades. It is important to construct the ramps at a 5% or less grade to help accommodate future ADA regulations and makes the structure more easily accessible by wheelchairs, bicycles, and eliminates the need for intermediate landings.

The City shall evaluate the opportunities for both an underpass and overpass at every crossing location prior to making the determination about which grade-separated crossing option to select.

## **5. Pedestrian and Cycling Supportive Site Design**

The DPM requires that, “All new roadways which are legal for bicycle use should be designed and constructed under the assumption that they will be used by bicyclists.”

The DPM provides the following guidance for accommodating bicycles on new streets:

- a) Development of Bike Lanes on New or Reconstructed Roadways



Bike lanes should be provided on all new or reconstructed arterial and collector roadways.

Recommended minimum widths for bicycle lanes are as follows:

- 5 feet, measured from painted edgeline to edge of gutter, on roadways with posted speed limits of 40 mph or greater.
- 4 feet, measured from painted edgeline to edge of gutter, on roadways with posted speed limits of 35 mph or less.

Bike lanes shall be flush with roadside gutters and should be marked in accordance with the MUTCD and AASHTO guidelines. Future roadway improvements should retain existing bike lanes, including intersection approaches where additional turn-lanes may be constructed.

The DPM also states that, “In new residential or commercial developments adjacent to bikeways, contiguous walls or fences should provide breaks for paved bicycle access which link the development to the bikeway system. Access(es) should be delineated on the sketch plat, preliminary plat and/or site development plan as appropriate.”

## 6. Bike Routes to Transit

Safe-Secure and easy access to bicycle parking facilities is necessary to encourage commuters to access transit via bicycle. Bicycling to transit reduces the need to provide expensive car parking spaces, mitigates peak-hour congestion and promotes active, healthy lifestyles.

Providing bicycle routes to transit helps combine the long-distance coverage of bus travel with the door-to-door service of bicycle riding. Transit use can overcome large obstacles to bicycling, including distance, hills, riding on busy streets, night riding, inclement weather and breakdowns. Providing bicycle access to transit and space for bicycles on buses can increase the feasibility of transit in lower-density suburban areas where transit stops are beyond walking distance of many residences. People are often willing to walk only a quarter-mile to half-a-mile to a bus stop, while they might bike as much as two or more miles to reach the bus station. As the majority of bus stops do not provide long-term, secure parking options for bicycles, most people who ride to a bus stop will want to bring their bicycle with them on the transit portion of their trip.

The local bicycle network should connect to transit stations, particularly higher-volume hubs that provide bicycle parking. The TCRP report, Bicycle and Transit Integration also recommends bicycle paths from neighboring communities that are shorter in length than roadways, which is particularly important in areas with a disconnected street pattern. Signage on these routes should be clearly visible, using the bicycle symbol for bike routes and parking facilities.

High-visibility crosswalks and mid-block crossings are often appropriate treatments ~~to provide safer for~~ effective bicycle and pedestrian access to bus stops, particularly at high-usage transit stops. If a bus stop

is located mid-block, adequate crossing treatments should be provided based on the level of traffic on the roadway. All transit riders will need to cross the street to access or leave the bus stop.

## **EF. Wayfinding**

Wayfinding needs of on-street and multi-use trail users are similar but the location identification infrastructure differs. On-street bikeways benefit from an existing street name, address and signing system. This type of system currently does not exist for the multi-use trail network. The City's multi-use trails are named but a mile marker system means of location identification and signing needs to be established. This section will address the improvements for a wayfinding of the on-street and multi-use trail facilities. The ability to navigate through a city is informed by landmarks, natural features and other visual cues. Signs throughout the city can indicate to pedestrians and bicyclists their direction of travel, location of destinations and travel time/distance to those destinations.

### **1. On-Street**

#### ***Bike Routes***

Bike routes should be identified using the bike route sign D11-1. Placement should be at the beginning and end of the bike routes, using the M4-14 and M4-6 plaques (Figure 1). Where routes split or shift to an intersecting street, advanced turn arrows (M4 series) and directional arrows (M5 series) shall be used to indicate the change in direction. The D11-1 sign can be placed occasionally along the bike route to help in wayfinding. Other signs that provide additional route identity are the bicycle warning sign W11-1 with the Share-the-road plaque W16-1P (Figure 2) and bicycle may use full lane R4-11 (Figure 3). These signs can help remind motorists and cyclists of the presence of a bicycle facility.

Pavement markings can be used to provide awareness of the presence of the bicycle facility as well as wayfinding guidance.

Pavement markings Sharrows (Figure 4) and bike route "pavement direction indicators" or bike blazes (Figure 5) can be effective and durable additions to help guide the cyclist along their route. The bike blaze can be used to indicate changes in direction of the bike route.

#### ***Bike Lanes***

Bike lanes are separate travel lanes for use by bicycles. The bike lanes are marked using a lane edge stripe between the motor vehicle lane and the bike lane and include bike lane symbols and bike lane signs (R3- 17). Where bike lanes change direction or at the junction with another bike lane, directional arrow sign plaques (M4 and M5 series) should be included. These simple additions to the built environment can provide adequate guidance for the cyclist to aid in route identification. Figure 9B-4 in chapter 9 of the MUTCD shows a selection of guide signs and plaques that can be used to inform bicyclists of bike route direction changes and to confirm route direction, distance and destination.

## Bicycle Boulevards

Bike boulevards are roadways in which bicyclists share the pavement with motor vehicles, but the facility is optimized in favor of the bicycle. Bicycle boulevards are characteristically slower than residential streets to the extent that posted speed limits are non-typical (18 mph vs. 25 mph). The non-typical speed limit is intended to call attention to the bike boulevard's posted speed being different from a normal roadway.

The City recently developed a series of signs and pavement markings to provide identification for the bicycle boulevards. The color and logo of these signs are unique to the Bicycle Boulevard and provide identification, guidance and wayfinding for the cyclist alerting the motorist to the unique character and operations of the bicycle boulevard (Figure 6).

### On-Street Signage Guidelines

Signage for on-street bikeways can serve both wayfinding and safety-informational purposes including:

- Helping to familiarize users with the bicycle network.
- Helping users identify the best routes to destinations .
- Helping overcome a “barrier to entry” for people who are not frequent cyclists or pedestrians.
- Visually cue motorists that they are driving along a bike route and should use caution.
- Including mileage and travel time estimates minimize the tendency to overestimate the amount of time it takes to travel by bicycle (Figure 8).

### Identifying Destinations for Signage

Destinations for on-street signage can include:

- On-street bikeways (regional or local)
- Commercial centers
- Regional or local parks and trails
- Public transit sites
- Civic or community destinations (hospitals and schools)
- Area destinations (e.g., cities, downtowns or neighborhoods)



Figure 6a



Figure 7 - Wayfinding signage concept.



Figure 8 - Wayfinding that includes distance and time can address misperceptions about time and distance.



### *Placement Standards and Techniques*

Too many road signs clutter the right-of-way. Signs should be placed at key locations to and along bike routes, including:

- Confirmation signs designate bikeways to bicyclists and drivers.
- Turn signs indicate where a bikeway turns from one street onto another street.
- Decision signs mark the junction of two or more bikeways and include destinations and associated directional arrows.

#### **Additional recommended guidelines include:**

- Place the closest destination to each sign in the top slot, allowing the nearest destination to fall off the sign and subsequent destinations to move up as the bicyclist approaches.
- Use pavement markings to help reinforce routes and directional signage. Markings, such as bicycle boulevard symbols (Figure 9), bike blaze and sharrow may be used in addition to signs along bike routes and can help cyclists navigate difficult turns in route.

### *Pavement Markings*

In general, pavement markings supplement or reinforce the regulatory signage, and are comprised of striping, text, and/or stenciled figures.

- Centerline striping shall be used to help define directions of travel or separate different user groups on multipurpose trails and be yellow per AASHTO's recommendations, while solid white edge striping gives trail users visual reinforcement of the limits of the trail surface, which is particularly valuable in low light conditions (especially if a potentially hazardous condition exists beyond the edge of the trail).
- Text is generally intended to convey warnings of changing conditions ahead, although it is sometimes used in place of vertical regulatory signage (such as "Yield" signs). Figures usually take the form of arrows or other symbols, or may be used to designate portions of the trail for different modes of travel.
- Striping along a trail should be consistent, as any change in color, thickness or width can be perceived as an indication of an expected change. An example of this would be changing from dashed to solid striping on sharp curves which require cyclists to slow down (as described in the Trail Alignment section above).
- Placement of text on the pavement, rather than on post-mounted signs, can reduce potential vandalism and/or graffiti targets; however, they are more easily overlooked, and are easily



Figure 9 - Bicycle Boulevard pavement marking.

obscured by snow or wind-blown debris. Therefore, critical signage such as “Stop” signs should still be provided on posts alongside the trail.

### *Guidance*

Both AASHTO and MUTCD provide additional guidance on striping trail facilities.

## **2. Multi-use Trails**

Development of a consistent signage system is an important element in the creation of a unified and recognizable trail system in metropolitan Albuquerque. Signage can be grouped broadly into two categories: regulatory and informational. Regulatory signage includes warnings, regulations, and directives applicable to trail use in general (Stop, No Motor Vehicles, Trail Etiquette, etc.), while informational signage would refer to a signage package specific to a particular trail and location, providing information such as the trail name (especially at designated trailheads), connections to other trails or facilities (through maps or directional arrows), and distances to key destinations. In an effort to expand trail accessibility, these signs also often include information such as trail length, grades, cross slopes, and obstacles which may be encountered (see Trail Difficulty Rating System on [page 6](#)).

Wayfinding can be a challenge for most trail users. A system needs to be established to provide effective wayfinding for the trail users and location identification for emergency responders.

### *Trail identification*

Multi-use trails are typically identified by name, usually coinciding with the major feature which they parallel such as an arroyo, highway or geographical location. Examples of these are the Bear Canyon, I-40 trail and Paseo del Bosque multi-use trails. Knowing where you are on these trails can be difficult due to lack of an addressing system. A logical system needs to be established that provides the trail user with their location and direction of travel. Multi-use trails shall follow the following conventions with regards to direction and location.

#### **Trail Name**

- Officially recognized trails should all have names. Trail names should be memorable, informative, and linked to specific trail sections.
- Names are more useful when easier to recall. In general, words are more memorable than numbers. More specific names are better than generic ones (“Sandia Crest Trail” rather than “Long Trail”). Sets of trail names should be easy to distinguish (avoid sets like “Tramway Trail”, “Tramway Hills Trail,” “Tramway Heights Trail” etc). Using both Spanish (“Paseo de las Montañas”) and English (“North Diversion Channel Trail”) adds to distinctiveness and honors New Mexico’s multilingual heritage (in part).
- Trail names can be useful when they provide information on trail location, trail connections and character or function of the trail. Many of the paved trails in the Albuquerque area are named for the roads or watercourses that they parallel. This helps locate where they are, but can be

problematic when trails or trail sections only follow a part of a road or watercourse that runs a long distance. Names like “Mariposa Linear Park” and “Emery Trail” show links to Mariposa Basin, and the Michial Emery trailhead respectively.

- Separate trail sections should receive distinct names, even if along same road or watercourse. Sections can be distinguished by suffixes such as “east, central, west” or other appropriate divisions. Foothills trail 365 should be divided into “North” and “South” sections.

### **Trail direction and mile marker**

- The trail names shall be posted on trail signage at street and trail intersections. Stencils on paved trails offer a defacement-resistant alternative to traditional post-mounted, eye-level signage.
- Multi-use trails that have a predominantly south/north alignment shall have a mile marker designation that begins at mile zero at the southern terminus of the trail. If there are plans to extend the trail towards the south the mile marker shall begin at the future southerner terminus of the planned extension. The mile markers shall increase along the trails alignment in the northerly direction.
- Multi-use trail that have a predominantly west/east alignment shall have a mile marker designation that begins at mile zero the existing western terminus of the trail. If there are plans to extend the trail to the west the mile marker shall being at the future western terminus of the planned extension. The mile markers shall increase along the trails alignment in the easterly direction.
- When posting mile marking information shall be shown to the nearest 1/10th of a mile in decimal format. Whole number mile marks shall use a decimal point followed by a zero.

### **Trail location**

- Locations on a trail shall be identified by the distance from the beginning terminus of the trail expressed in miles and tenths of miles.

It would be beneficial to the trail users to include on the City’s bike map multi-use trail mile markers at major locations such as trail heads, trail/trail intersections and trail/street intersections. Emergency responders should be aware of the multi-use trail identification system and incorporate it into their dispatching protocol.

### *Guidance*

Trail identification/location marking and wayfinding can be comprised of signs, trail heads, kiosks, maps and pavement markings. The type of location marking is dependent on the location and anticipated needs of the trail users.

### *Regulatory Signs*

#### *Design Considerations & Guidelines*

Regulatory signage should be placed where most visible and effective, and should be grouped, where practical and appropriate, to minimize the number of posts (potential obstacles). In some cases, free-

standing signs may be replaced by pavement markings, for the same reasons. (A specific example would be to replace “Stop Ahead” signs with the same message painted on the trail surface. See Pavement Markings discussion below.) Sizing and placement should be in accordance with the most recent version of the Federal Highway Administration’s Manual on Uniform Traffic Control Devices (MUTCD) Part 9, Bicycle Facilities. However, the City Parks and Recreation Department has developed a few signs that will give Albuquerque’s paved multi-use trail network its own sense of community and style. The following are examples of what the Parks and Recreation Department has implemented since 2013. See [Figure 20, below](#):

**Figure 18: Trail Etiquette Signs**



Informational signage should be dealt with on a trail-by-trail basis, developing a logo or theme for each trail, and developing a signage package which reflects that theme. This package has been designed with a standardized mounting system and graphic medium which can be easily modified or replaced as the trail system grows. However, creativity and customization of the trail-specific informational package, post (or alternative mounting) configuration and thematic colors are encouraged, in order to develop individual identities for each trail facility.

### ***Pavement Markings***

In general, pavement markings supplement or reinforce the regulatory signage, and are comprised of striping, text, and/or stenciled figures. Centerline striping shall be used to help define directions of travel or separate different user groups on multi-purpose trails and be yellow per AASHTO’s recommendations, while solid white edge striping gives trail users visual reinforcement of the limits of the trail surface, which is particularly valuable in low light conditions (especially if a potentially hazardous condition exists beyond the edge of the trail). Text is generally intended to convey warnings of changing conditions ahead, although it is sometimes used in place of vertical regulatory signage (such as “Yield” signs). Figures usually take the form of arrows or other symbols, or may be used to designate portions of the trail for different modes of travel.



### *Design Considerations & Guidelines*

Striping along a trail should be consistent, as any change in color, thickness or width can be perceived as an indication of an expected change. An example of this would be changing from dashed to solid striping on sharp curves which require cyclists to slow down (as described in the Trail Alignment section above).

Placement of text on the pavement, rather than on post-mounted signs, can reduce potential vandalism and/or graffiti targets; however, they are more easily overlooked, and are easily obscured by snow or wind-blown debris. Therefore, critical signage such as “Stop” signs should still be provided on posts alongside the trail.

### *Guidance*

Both AASHTO and MUTCD provide additional guidance on striping trail facilities.

### *Signage Location*

#### **Trail head**

Trail head identification should be used to indicate the terminus of the trail, thus informing users approaching the trail from an intersecting trail and when users are leaving a specific trail to use another trail. The trail head can be as simple as a sign identifying the trail by name or more informative by including additional information, such as the City’s Bike Map, or a map emphasizing the trail and showing the trail length, major destinations and distances and 911 emergency reporting instructions. A kiosk can provide a good location to display this information in addition to trail etiquette educational information and pet waste cleanup stations. Trail appurtenances near the kiosk may also improve user satisfaction and aid in alerting quick moving commuters to the congested quality, which maybe present near the kiosk as shown in the figure at the right.

#### **Mid-trail marking**

Mid-trail markings should be placed at 0.5 mile intervals starting at the southern or western trail terminus and shall include the trail name and mile marker. A combination of a pavement marking and sign can be used or pavement marking solely. Pavement markings showing the trail name and mile marker shall be placed on and parallel to the trail centerline using retro-reflective pavement marking utilizing a 4-inch high white letters and numbers. When a sign is used, a single, double-sided sign shall be placed on the right side of the trail in the direction of increasing mileage. The sign shall be a flexible fiberglass composite extending 3 feet above ground displaying the mile marker and optionally the trail name. An example of the mid-trail pavement marking and sign is shown in Figure 11.

#### **Trail/street intersections**

Where a multi-use trail intersects a street the trail name, trail mile marker and street name shall be displayed. In addition destination guide signs may be appropriate.

### **Intersection sign**

A post mounted street name sign, similar to a D3-1 with 4-inch initial upper-case letters with 3-inch lower-case letters, shall be located on the right side of the trail near as particle to the edge of the street right-of-way. These signs shall display the trail name and street name. For trails with long names appropriate abbreviations can be used.

### **Intersection pavement marking**

The street name shall be shown using retro-reflective pavement marking in 6-inch high white letters placed perpendicular to the trails centerline approximately 10 feet from the intersection. The trail name and mile marker retro-reflective pavement marking shall be placed on and parallel to the trail centerline using retro-reflective pavement marking using 4-inch high white letters and numbers and should be placed approximately 25 feet before the intersection. Figure 12 shows the preferred layout for trail identification markings.

### **Trail/trail intersections**

Where multi-use trails intersect the trail names and mile markers shall be shown using signs and pavement markings.

### **Intersection sign**

Post mounted signs displaying both trail names, similar to a D3-1 sign with 4-inch initial upper-case letters with 3-inch lower-case letters, shall be located at the intersection. For trail with long names appropriate abbreviations can be used.

### **Intersection pavement marking**

The trail name, for each trail, shall be shown using retro-reflective pavement marking in 4-inch high white letters and numbers. The multi-use trail name and mile marker shall be placed on and parallel to the center line of the trail approximately 25 feet before the intersection. Figure 13 shows the preferred layout for trail identification markings.

## **FG. Maintenance & Operations**

Properly maintaining the City's bikeways and multi-use trail system is vital to the longevity and usefulness of these facilities. This plan addresses issues concerning pavement preservation, sweeping, pavement marking and signs, vegetation control, drainage, crack sealing/filling and a Spot Improvement Program for bikeways and multi-use trails. Recommendations include monitoring the frequency of sweeping requests and the identification of areas that typically require more than the normally scheduled sweeping, puncture vine control using biological and herbicidal methods and proper use of landscape materials next to multi-use trails.

For on-street bikeways, pavement preservation, signs, pavement markings and sweeping are the responsibilities of Street Maintenance Division. Multi-use trail pavement preservation, signs and

pavement markings, vegetation control and sweeping are the responsibilities of Parks and Recreation Maintenance Division.

## 1. On-Street Bike Facility Maintenance Considerations

Like all roadways, bike lanes, routes, and bike boulevards require regular maintenance. This includes sweeping, maintaining a smooth roadway, ensuring that the gutter-to-pavement transition remains relatively flat and installing bicycle-friendly drainage grates. These considerations are particularly relevant to bike lanes, as cyclists have a narrow corridor to traverse.

### *Surface*

Bicycles are much more sensitive to subtle changes in roadway surface than are motor vehicles. Various materials are used to pave roadways and some are smoother than others. Compaction is also an important issue after trenches and other construction holes are filled. Uneven settlement after trenching can affect the roadway surface nearest the curb where bicycles travel. Sometimes compaction is not achieved to a satisfactory level, and an uneven pavement surface can result due to settling over the course of days or weeks. For more information, see BikeSafe Repetitive/Short-Term Maintenance document: [www.bicyclinginfo.org/bikesafe/countermeasure.cfm?CM\\_NUM=-4](http://www.bicyclinginfo.org/bikesafe/countermeasure.cfm?CM_NUM=-4)

- Ensure that on new roadway construction, the finished surface on bikeways does not vary more than 1/4 of an inch.
- Maintain a smooth surface of all bikeways that is free of potholes.
- Maintain pavement so ridge buildup does not occur at the gutter-to-pavement transition.

### *Pavement preservation*

The surface condition of on-street bicycle facility pavement has a significant effect on the quality of the riding experience. Ride comfort ~~and safety~~ depends on a smooth, crack-free paved surface without longitudinal ridges between pavement lifts or along gutter edges. Longitudinal pavement cracking or separation between adjacent surfaces wider than half an inch can potentially be hazardous, trapping bicycle wheels and causing crashes.

Transverse cracking, while less hazardous than longitudinal cracks, degrades the ride quality. In areas where motor vehicles normally do not travel, such as bike lanes and shoulders, transverse cracking can degrade further resulting over time into ridges along the edges of the crack a condition that cyclist tend to avoid riding on choosing to use the driving lane instead of the designated bike lane or shoulder.

**Crack sealing:** Crack sealing is used as a first defense against further pavement deterioration because it offers important benefits. Effective crack sealing keeps water from entering and weakening the base or sub-base. It helps preserve the pavement adjacent to the cracks and extends pavement life by minimizing crack growth. Cracks are typically sealed using rubberized hot pour material that can be problematic for cyclists to ride over. Caution should be used when sealing cracks that run in the direction of travel, as this material can cause loss of handling and lead to loss of control of the bicycle. Sealing transverse

cracks often creates a ridge, degrading the ride quality. Crack sealing, shown in Figure 1, should be used as a temporary means of pavement preservation.

**Slurry Seal Overlay:** A mixture of emulsified asphalt, fine aggregate, mineral filler and water. The slurry seal is placed on the surface of the existing pavement adding  $\frac{1}{4}$  of an inch to the pavement thickness.

**Micro-Surfacing Overlay:** A composition of polymer asphalt emulsion and selected fine aggregate. It is applied cold and can be placed in thicknesses up to 1.5 inches.

Properly applied Slurry Seal and Micro-Surfacing can provide a smooth riding surface extending the pavement life. Care must be exercised to minimize the ridge along the gutter lip at the pavement/gutter interface.

**Chip Seal:** Chip Seal is an application of a binder in the form of an emulsion or hot spray and an application of an aggregate as close to single size as possible. Chip seal should not be used for bikeways.

**Heater Scarification:** Heater scarification is a process of heating the surface of the existing pavement with either natural gas fired burners or infrared heaters, scarifying the softened surface with ripper teeth and spraying it with a rejuvenating agent. This material is all mixed together in an auger chamber and leveled with a screed. Pneumatic rollers compact the loose mixture in preparation for the overlay.

**Heater Repaving:** This process is similar to the heater scarification process. First the pavement is heated, then scarified and a rejuvenating agent is then added and it is mixed. At the same time that this process is performed, a layer of hot mix asphalt is placed over the heated recycled surface. A screed is then used to level the pavement. The pavements are then compacted. The scarification is usually between  $\frac{3}{4}$  to  $1\frac{1}{2}$  inches deep.

Care must be exercised when using pavement overlays to minimize the ridge along the gutter lip. Examples of pavement overlays with acceptable pavement/gutter interface can be seen in Figure 2 and unacceptable ridge along the gutter lip at the pavement/gutter interface can be seen in Figure 3.

**Mill and inlay:** Milling of an asphalt concrete pavement surface refers to the mechanical removal of a part of the pavement surface. There are several applications of the milling process. The most common is to remove an unstable surface that exhibits excessive distresses, such as roughness, cracking, rutting or raveling, and reduce pavement build up to eliminate the need to raise drainage structure elevations and to have paved surfaces match gutter elevations. After milling the asphalt pavement surface, a lift of asphalt is placed on the milled surface to provide a new roadway surface. Again, as when using pavement overlays, care must be exercised to minimize the ridge along the gutter lip at the pavement/gutter interface.



### *Sweeping*

Accumulation of debris on streets comes from many different sources. This includes natural sources, such as plan material and road kill; systemic sources, such as debris from adjacent driveways and improperly used landscaping; and human generated debris, such as crash debris, litter and broken glass. Reduction, prevention and management are important in keeping a clean and [safe-functional](#) facility. Loose debris on a bicycle facility can cause loss of traction, flat tires and hazardous conditions for the cyclist.

Bicycles have a lower tolerance than motor vehicles for objects on the roadway surface. Broken glass, small gravel, sand and twigs can easily be driven over by most motor vehicles without causing problems. A small object on the roadway can be big problems for bicycles. Those objects can result in an unsuitable riding condition for a bicycle. Additionally, the aforementioned debris tends to migrate from the wheel paths of driving lanes to the bike lane. With this in mind sweeping requirements for bicycle facilities differ from those needed for motor vehicles. The frequency of bicycle facility sweeping may need to be increased over what is normally scheduled for roadways. Gravel and sand coming from an unpaved driveway shown in Figure 4 can easily be driven over by motor vehicles but can cause problems for cyclists. It may be advantageous to collect data on the condition of the bicycle facility during scheduled sweeping and when requests are made for additional sweeping. This data could be used in determining the areas that require more attention, providing supporting data when requesting maintenance budgets and the development of effective bicycle facility sweeping schedules.

### *Pavement markings*

Several methods of pavement marking are available: Paint, hot thermoplastic and preformed plastic. All of these methods have similar requirements for retro-reflectivity and color while the cost and durability depends on the specific type of marking material. Bicycle facility pavement markings should be maintained with emphases on retro-reflectivity, legibility and discoloration. When the pavement markings are determined to be deficient replacement or repainting of the marking is required.

Repaving of a roadway can provide an opportunity for the City to reconfigure the roadway cross-section to include bicycle facilities. In many cases this can be done inexpensively and quickly in the restriping process by including bicycle facilities where feasible. On repaved roadways with bicycle facilities the pavement markings shall be replaced to match the pavement marking configuration as they were prior to the repaving.

### *Drainage Grates*

Drainage grates are located in the gutter area near the curb of a roadway. They typically have slots to drain water into the municipal storm water system. Many grates are designed with linear parallel bars spread wide enough for a tire to become caught so that if a bicycle were to ride on them, the front tire would become caught and fall through the slot. This would cause the cyclist to tumble over the handlebars and sustain potentially serious injuries.

- Require all new drainage grates be bicycle-friendly, including grates that have horizontal slats on them so that bicycle tires do not fall through the vertical slats.
- Consider a program to inventory all existing drainage grates and replace hazardous grates as necessary.



*Examples of bicycle-safe drainage grates.*

### *Signs*

Signs have a finite life span due to the degradation of the reflectivity and fading and should be replaced when they no longer are legible or meet the retro-reflectivity requirements. Signs that are missing or damaged from graffiti and/or crashes should be cleaned or replaced. Care in cleaning must be exercised as to not degrade the retro-reflectivity of the sign, erase the sign message or change the sign color. In locations where graffiti is more common anti-graffiti coatings on sign faces or sign face materials that can withstand graffiti removal should be considered.

### *Vegetation control*

Encroaching vegetation shall be kept away from the bicycle facility and roadways in general. Vegetation shall not block signs or line of sight at intersections and provide at least 8 feet of vertical clearance above the bicycle facility. Periodic trimming of vegetation, especially when leaves are on the plants, may be required. Mowing of weeds and grasses along the roadway edges should be done before they encroach into the bikeway. Sweeping after mowing may be needed to remove debris from the bikeway.

### *Drainage*

Drainage on roadways with curbs and gutters is normally conveyed along the outside edge of the roadway where the bike lanes typically are. During significant rain events the bike lanes will usually be inundated by the drainage, making them difficult or impossible for cyclist to use. After rain events debris that has accumulated due to runoff will need to be removed from the bicycle facilities (Figure 5). In locations where this happens frequently due to runoff, increased sweeping of the bikeway may be needed and the drainage system should be modified to prevent the debris accumulation. Catch basin grates should be bicycle-~~safe~~ready and replaced with the appropriate grate if not.

## 2. Multi-Use Trails

The burrs of Puncture Vine (known as goat heads) cause flat tires and injure pets and are the single most frequent complaint of trail users regarding on-going maintenance. Other maintenance concerns raised during public meetings and by the advisory groups largely relate to ~~safety~~ potential hazards on the trail: glass, gravel, or other debris on the trails, missing bollards with the collar exposed, plants encroaching on trails or blocking visibility, and asphalt that is cracked and in need of repair or replacement.

### *Pavement preservation*

As asphalt pavement ages, it tends to shrink, creating transverse cracks. Thermal expansion and contraction cause cracks to become wider, creating an unsuitable riding surface. Multi-use trails are typically not susceptible to longitudinal cracking, as the width of the trail allows for it to be paved in a single pass by the asphalt lay-down machine. However, new designs and full depth reclamations shall take care to avoid creating an edge of pavement drop-off of more than 1.5 inches. This can be achieved by using a tapered asphalt section.

**Crack sealing:** Crack sealing of multi-use trail asphalt pavement is similar to that of the on-street facility. It is the first defense against further pavement deterioration, but it is a temporary measure. Caution should be used when sealing to prevent ridges that are problematic for people using trails. In addition to the rubberized hot pour material, a ridged crack fill for cracks wider than half an inch has been used with limited success. Over time shrinkage of the asphalt pavement can cause the ridged crack fill material to pull away from the crack edges, thus producing another crack (Figure 6). Narrow crack should not be repaired using rigid material (Figure 7) because it will not enter the crack and remain on the pavement surface creating a ridge.

**Full Depth Reclamation:** (Bomag®) Cold Mix-In-Place-Recycling, Full depth reclamation is an in-situ process that grinds up the existing asphalt pavement and aggregate base course, mixes both together and replaces it back on the sub-grade soil. This homogeneous mixture is then re-compacted and ready for a new asphalt pavement.

Street Maintenance Division, DMD should assist Park Management in determining the most effective methodology for extending pavement life and the two divisions should also explore sharing responsibility for addressing these issues.

### *Sweeping*

Keeping the trail surface clear of debris is important for the ~~safety~~ security and comfort of trail users. Trails should be swept on a scheduled basis and when requested. Locations that historically require more frequent sweeping should be noted and investigated as to what may be causing this problem and fix if practical. Locations that need immediate sweeping (Figure 10) should be reported to the City.

### *Pavement markings*

Generally, trails have a few simple markings (e.g., a yellow center line); however, these should be repainted or replaced when necessary.

### *Signs*

Signs have a finite life span due to the degradation of the reflectivity and fading and should be replaced when they no longer are legible or meet the retro-reflectivity requirements. Signs that are missing or damaged from graffiti and/or vandalism should be cleaned or replaced. Care in cleaning must be exercised, so as to not degrade the retro-reflectivity of the sign, erase the sign message or change the sign color (See Figure 9). In locations where graffiti is more common anti-graffiti coatings on sign faces or sign face materials that can withstand graffiti removal should be considered.

### *Vegetation control*

**Trimming:** Vegetation shall not block signs or line of sight at intersections and horizontal curves.

Additionally, ground level vegetation shall not protrude beyond the edge of the trail shoulder. Periodic trimming of vegetation especially when leaves are on the plants may be required. Mowing of weeds and grasses along the trail edges should be done before they encroach beyond shoulder of the trail. Sweeping after mowing may be needed to remove debris from the trail surface.

**Root Control:** Root heave seriously degrades pavements. It is characterized by a sharp hump and cracking along a sporadic path (Figure 10). When the pavement is damaged by root heave the pavement in the immediate area will need replacement along with removal of the offending roots.

### *Noxious Weed Control*

Control of weeds like Puncture Vine (*Tribulus terrestris*), more often referred to as goat heads, can be difficult. There are no quick and lasting solutions. Two methods are currently used by the City with limited success: mechanical and chemical. Two other methods, encouraging native species and biological, should be considered for experimentation.

**Mechanical:** This involves the cutting and removal of the growing, ground hugging vine. It is a time consuming process that should be performed before the plant's seeds mature. If the cut plants have mature seeds care in handling should be used so as to not drop and distribute the seeds.

**Chemical:** Park Management has used both pre- and post-emergent herbicides to control goatheads. Effective weed control with chemicals is highly dependent on timing. Other issues related to chemical use include chemical sensitivities of some trail users, proximity of trails to channels or other drainage structures, impacts on beneficial insects, and potential damage to nearby desirable plants. Each of these issues should be considered when developing and implementing a chemical treatment approach.

Approved aquatic herbicides are allowed when a trail is next to a channel or other drainage structure. The post-emergent herbicide Aquamaster (Rodeo) is an approved aquatic pesticide being used by



AMAFCA and MRGCD. Our understanding is that it can be used as needed where there is: bare ground, monotypic stands of goat heads, or spot application is done selectively being careful to avoid natives. Clarification of its usage and proper application procedures should be confirmed with the Pesticide Compliance trainer. NMDOT uses a different herbicide, VistaXRT which they report is both a pre- and post-emergent.

There are pre-emergent herbicides that are effective. Products containing oryzalin, benefin, or trifluralin will provide partial control of germinating seeds. These must be applied late winter to mid-spring prior to germination. After plants have emerged from the soil (post-emergent), products containing 2,4-di-chlorophenoxyacetic acid ("2,4-D"), glyphosate and dicamba are effective on puncture vine. Like most post-emergent, they are more effectively maintained when caught small and young. Some people have sensitivities to these herbicidal chemicals and prefer that they be used limitedly or not at all. Temporary warning sign indicating when herbicides are being applied may be helpful to inform the public of their use.

**Competition:** Good stands of native grasses and plants along the trails significantly reduce the goat head problem. Trail managers broadly agree that if we can get native grasses and other desirable native plants (ones that don't require irrigation and a lot of mowing) established next to the asphalt trails, the use of herbicides can be reduced over time, the weed problem can be abated, and the trails will be more pleasant to users, both aesthetically and practically. Thick stands of native grasses and other herbaceous natives have the added benefit of protecting the trail shoulder from erosion.

However, establishing native grasses and forbs without irrigation is highly dependent on rainfall and other weather variables. The first step is to protect and encourage existing stands of native plants as much as possible during initial construction or reconstruction. Reclamation seeding should be required along newly constructed or rebuilt trails (reference most recent City Standard Specifications for native seeding along trails.) Establishment may require protection from foot traffic. Other management practices impact the health of native vegetation and its ability to out-compete weeds along the trails. These include mowing height (which should be no shorter than 4-6"), mowing frequency (no more than 3 times per year), and minimizing soil disturbance.

Knowledge of plants is critical, allowing for selective control of undesirables, while protecting desirable vegetation. Because establishing native grasses without irrigation is highly dependent on rainfall and other weather variables, the first step is to protect and encourage existing stands of native plants as much as possible during initial construction or reconstruction. Reclamation seeding should be required along newly constructed or rebuilt trails (reference most recent City Standard Specifications for native reseeding along trails).

**Biological:** Two weevils, *Microlarinus lareynii* and *M. lypriformis*, native to India, France and Italy, were introduced into the United States as bio-control agents in 1961. Both species of weevils are available for

purchase from biological suppliers. Weevils can keep populations in check, but suppression is cyclic and not always effective. Weevils can keep populations in check, but suppression is cyclic and not always effective.

- *Microtharax lareynii* is a seed weevil that deposits its eggs in the young burr or flower bud. The larvae feed on and destroy the seeds before they pupate, emerge, disperse and start the cycle over again. Its life cycle time is 19 to 24 days.
- *Microtharax lypriformis* is a stem weevil that has a similar life cycle, excepting the location of the eggs, which includes the undersides of stems, branches and the root crown. The larvae tunnel in the pith where they feed and pupate. Adults of both species overwinter in plant debris. Although the stem weevil is slightly more effective than the seed weevil when each is used alone, the weevils are most effective if used together and the puncture vine is moisture-stressed.

More research is required regarding suitability in our climate. The NMSU Extension Service reported “that Dr. Gerald Nielsen at NM Department of Agriculture released the weevils in a test program in the mid- to late-1960s. The stem weevil failed to establish, apparently. The seed weevil seems widely established but not that impressive.” Extension agents we spoke with are not aware of any successful introductions in NM since that time. The Extension agents also reported having checked with Kerry Bryan, the State Plant Health Director with USDA-APHIS-PPQ. who said, in the event someone wants to bring in their own seed weevils for their use, they need to file a ‘526 form’ which is the official request for approval of interstate shipment of biological agents, beneficials included.

### *Mulch*

Gravel slope stabilization and other mulch ground cover material shall not be placed on steep slopes near the trail. When mulch is used, a minimum two-foot wide shoulder next to the trail’s edge should be kept free of this material. Uncontained mulch on a steep slope will migrate onto the trail creating a hazard for trail users (Figure 12). In locations where mulch has spilled onto the trail, the ground cover material should be replaced with a more stable material, the side slope near the trail re-graded to prevent material from spilling onto the trail or more frequent maintenance be performed at these locations to keep the trail free of debris.

Addressing these issues on private property where there are public trails will require an ordinance change to require different trail design standards related to course gravel adjacent to the trail edge. Stone smaller than a ¼” in diameter or smaller, or stabilized crusher fines are adequate options which preserve a recovery zone and pavement stabilization, a parallel path for pedestrians, and weed/maintenance. Cross reference DPM amendment recommendation in **Chapter 6.B.4.**

### *Drainage*

Drainage on trails is generally less of an issue than street facilities, as trails have a tapered or blunt edge without the confinement of a curb, which confines drainage and thus debris to the pavement. However,

trails typically are designed with tapered shoulders and parallel ditches. Where storm runoff drains off a side slope it should be directed away from the trail. Debris that is deposited on the trail from runoff should be removed as soon as possible (Figure 13). At locations where this occurs frequently, additional trail maintenance will be needed until the drainage problem is corrected.

### *Test Weed Control Strategies*

There is broad agreement that if we can get native grasses and other desirable native plants that don't require irrigation and a lot of mowing established next to the asphalt trails, the use of herbicides can be reduced over time, the weed problem can be abated, and the trails will be more pleasant to users, both aesthetically and practically. However, establishing native grasses and forbs without irrigation is highly dependent on rainfall and other weather variables. The first step is to protect existing stands of native plants as much as possible during initial construction or reconstruction.

We think it worthwhile for Parks Maintenance to consider potential ideas for test sections to try different strategies for weed control/establishment of native grasses and plants in narrow areas along existing trails to be designed and implemented by Park Management personnel or a contractor. These would include various combinations of soil prep (including ways of removing or reducing the existing weed seed bank), seeding of native grasses and forbs, and mulching (principally based on City of Albuquerque reclamation seeding specifications).

### **Additional thoughts for management after germination:**

- Mow high – no shorter than 4-6", no more than 3x per year. If vegetation and grasses in some locations start to crowd into the trail and narrow the clear width for travel, address with alternative mowing schedule.
- Practice selective weed control. Provide basic training in ID and recognition of desirable natives and a few true weed species. Reduce the use of herbicides.
- Protect established desirable grasses, wild flowers and shrubs. Reseed all disturbed areas. Don't scrape to control weeds.

For more information on goat heads, see this [link](#):

<http://www.cabq.gov/planning/documents/GoatheadSynopsisTBFPversion.pdf>